



SGM4871

2.4W Stereo Audio Power Amplifier with Shutdown Mode

GENERAL DESCRIPTION

The SGM4871 is a mono bridge-connected audio power amplifier which operates from 2.5V to 5.5V supply voltage. It can deliver 2.4W into a 4Ω load from 5V supply at THD+N = 10%. It is designed for portable applications. The external gain-setting resistors can configure the unity-gain stable of the device.

The SGM4871 has low power consumption shutdown mode and thermal shutdown protection.

The SGM4871 is applied to low power portable systems. Output coupling capacitors, bootstrap capacitors or snubber networks are not needed.

The SGM4871 is available in Green SOIC-8 and SOIC-8 (Exposed Pad) packages. It operates over an ambient temperature range of -40°C to +85°C.

FEATURES

- **Supply Voltage Range: 2.5V to 5.5V**
- **Output Power at THD+N = 10%, 1kHz**
SGM4871YPS8: 2.4W (TYP) into 4Ω Load
SGM4871YS8: 1.5W (TYP) into 8Ω Load
- **Shutdown Current: 0.07μA (TYP)**
- **No Output Coupling Capacitors**
- **External Gain Configuration Capability**
- **Unity Gain Stable**
- **Thermal Overload Protection Circuitry**
- **-40°C to +85°C Operating Temperature Range**
- **Available in Green SOIC-8 (Exposed Pad) and SOIC-8 Packages**

APPLICATIONS

Mobile Phones, PDAs
Portable Systems
Wireless Handsets

PACKAGE/ORDERING INFORMATION

MODEL	PACKAGE DESCRIPTION	SPECIFIED TEMPERATURE RANGE	ORDERING NUMBER	PACKAGE MARKING	PACKING OPTION
SGM4871	SOIC-8 (Exposed Pad)	-40°C to +85°C	SGM4871YPS8/TR	SGM4871YPS8 XXXXX	Tape and Reel, 2500
	SOIC-8	-40°C to +85°C	SGM4871YS8/TR	SGM4871YS8 XXXXX	Tape and Reel, 2500

MARKING INFORMATION

NOTE: XXXXX = Date Code and Vendor Code.

XXXXX

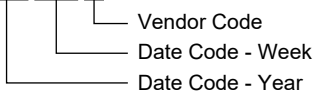

Green (RoHS & HSF): SG Micro Corp defines "Green" to mean Pb-Free (RoHS compatible) and free of halogen substances. If you have additional comments or questions, please contact your SGMICRO representative directly.

ABSOLUTE MAXIMUM RATINGS

Supply Voltage.....	5.5V
Input Voltage.....	-0.1V to (V ₊) + 0.1V
Junction Temperature.....	+150°C
Storage Temperature Range	-65°C to +150°C
Lead Temperature (Soldering, 10s).....	+260°C
ESD Susceptibility	
HBM.....	2000V
MM.....	200V

RECOMMENDED OPERATING CONDITIONS

Supply Voltage Range	2.5V to 5.5V
Operating Temperature Range	-40°C to +85°C

PIN CONFIGURATION

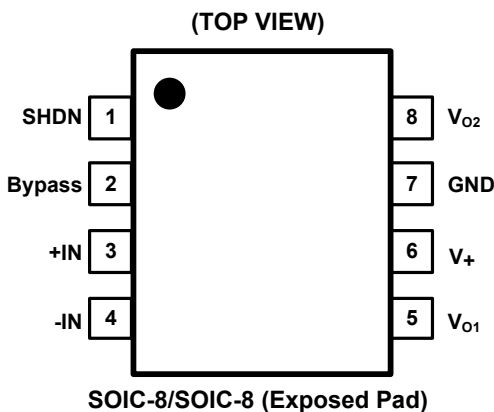

OVERSTRESS CAUTION

Stresses beyond those listed in Absolute Maximum Ratings may cause permanent damage to the device. Exposure to absolute maximum rating conditions for extended periods may affect reliability. Functional operation of the device at any conditions beyond those indicated in the Recommended Operating Conditions section is not implied.

ESD SENSITIVITY CAUTION

This integrated circuit can be damaged if ESD protections are not considered carefully. SGMICRO recommends that all integrated circuits be handled with appropriate precautions. Failure to observe proper handling and installation procedures can cause damage. ESD damage can range from subtle performance degradation to complete device failure. Precision integrated circuits may be more susceptible to damage because even small parametric changes could cause the device not to meet the published specifications.

DISCLAIMER

SG Micro Corp reserves the right to make any change in circuit design, or specifications without prior notice.

ELECTRICAL CHARACTERISTICS(The following specifications apply for $T_A = +25^\circ\text{C}$, $V_+ = 5\text{V}$ and $R_L = 8\Omega$, unless otherwise specified.)

PARAMETER	SYMBOL	CONDITIONS	MIN	TYP	MAX	UNITS
Supply Voltage	V_+		2.5		5.5	V
Output Offset Voltage	V_{OS}			5.5	65	mV
Quiescent Power Supply Current	I_Q	$V_{SHDN} = \text{GND}$	No Load	5.2	9	mA
			$R_L = 8\Omega$	5.3		
Shutdown Current	I_{SD}	$V_+ = 5.0\text{V}$, $V_{SHDN} = 5.0\text{V}$, $I_O = 0\text{mA}$		0.07	2	μA
Shutdown Voltage Input High	V_{SDIH}		1.2			V
Shutdown Voltage Input Low	V_{SDIL}				0.4	
Output Power (4 Ω)	P_O	$f = 1\text{kHz}$, THD+N = 1%		1.9		W
		$f = 1\text{kHz}$, THD+N = 10%		2.4		W
Output Power (8 Ω)	P_O	$f = 1\text{kHz}$, THD+N = 1%		1.2		W
		$f = 1\text{kHz}$, THD+N = 10%		1.5		W
Total Harmonic Distortion + Noise	THD+N	$20\text{Hz} < f < 20\text{kHz}$, $R_L = 8\Omega$, $P_O = 1\text{W}$		0.2		%
Power Supply Rejection Ratio	PSRR	$V_{SHDN} = \text{GND}$, $V_+ = 4.9\text{V}$ to 5.1V		70		dB

TYPICAL PERFORMANCE CHARACTERISTICS

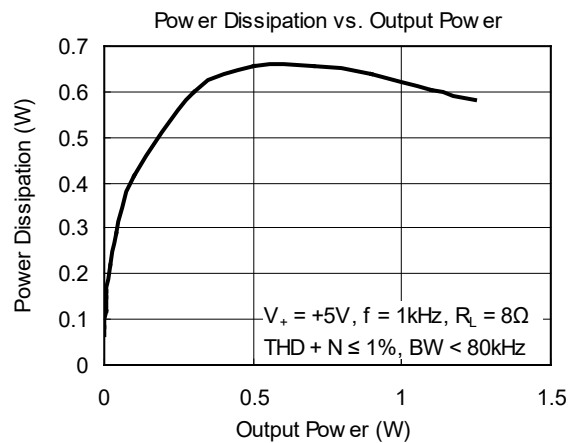
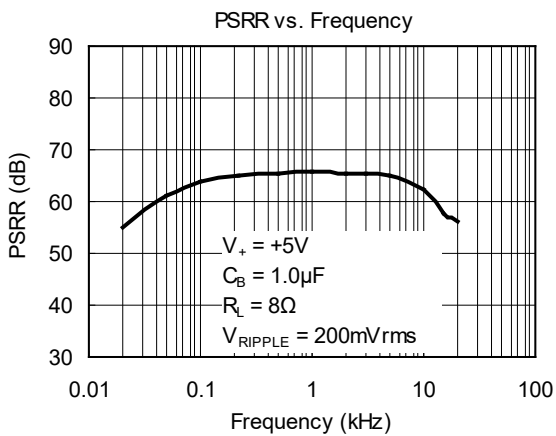
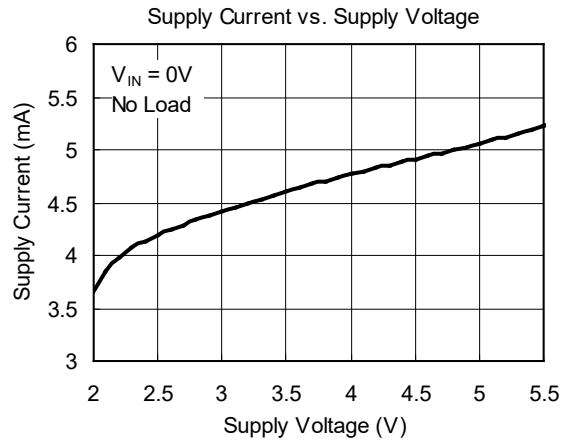
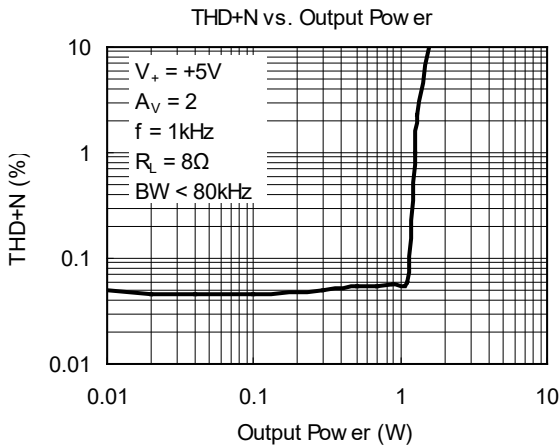
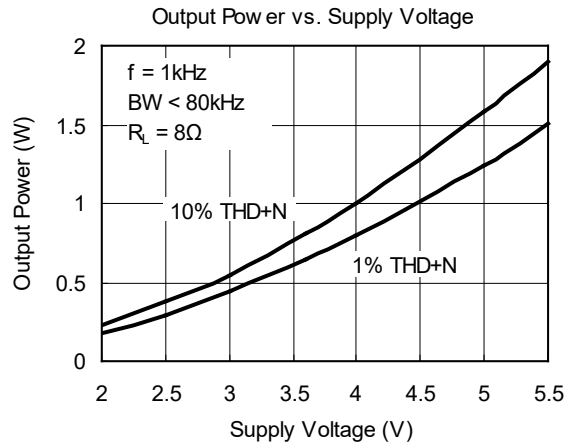
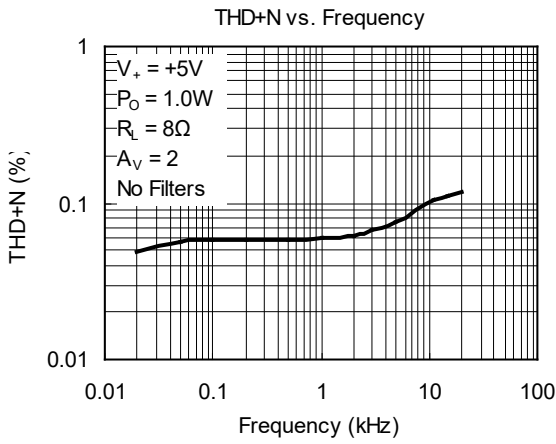

TYPICAL PERFORMANCE CHARACTERISTICS (continued)

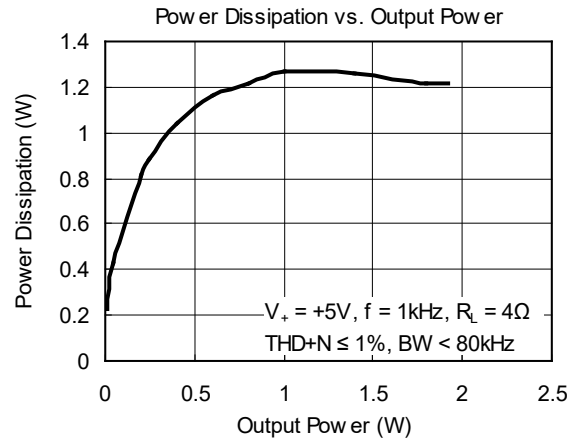
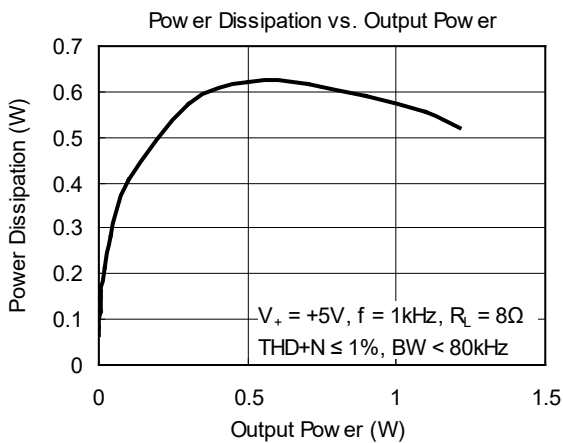
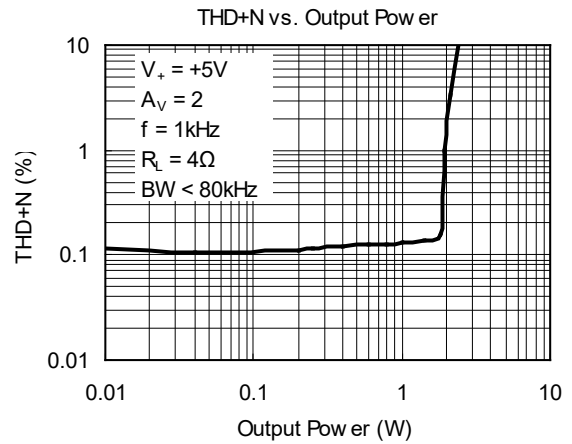
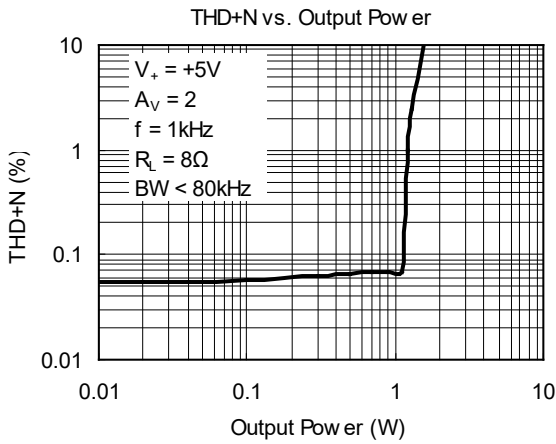
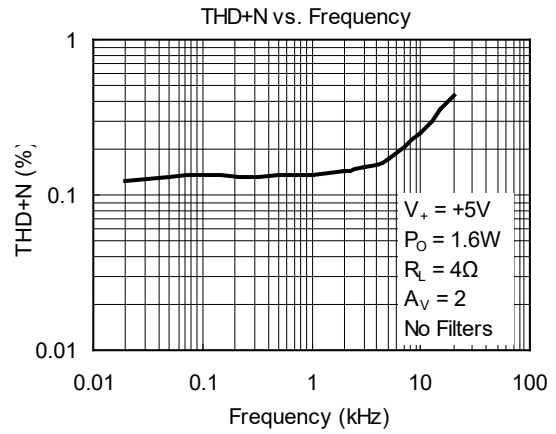
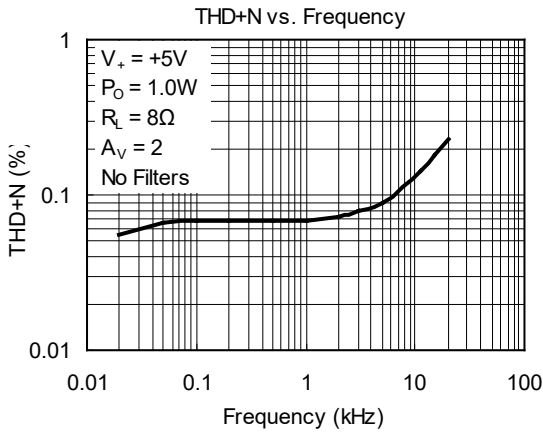

TYPICAL PERFORMANCE CHARACTERISTICS (continued)

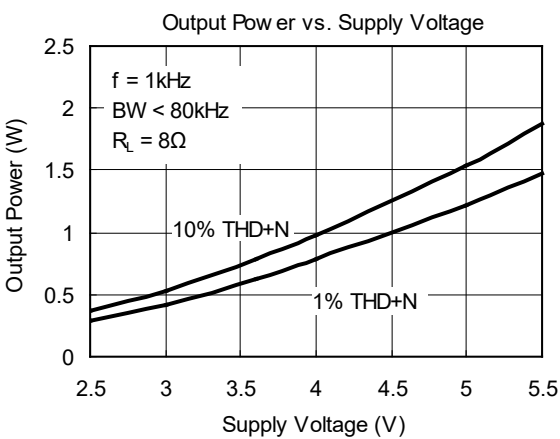
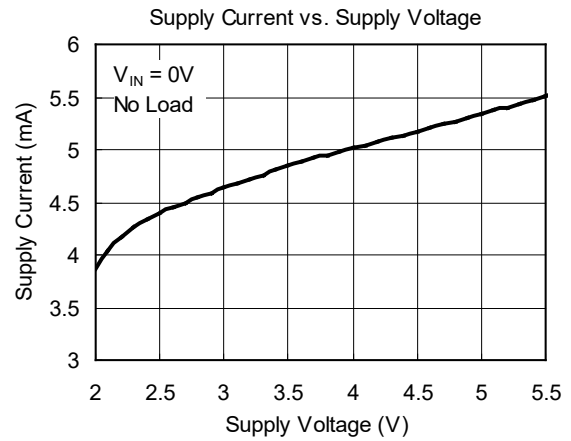
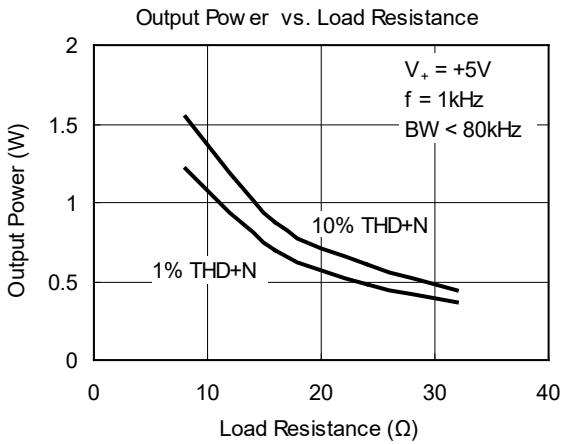
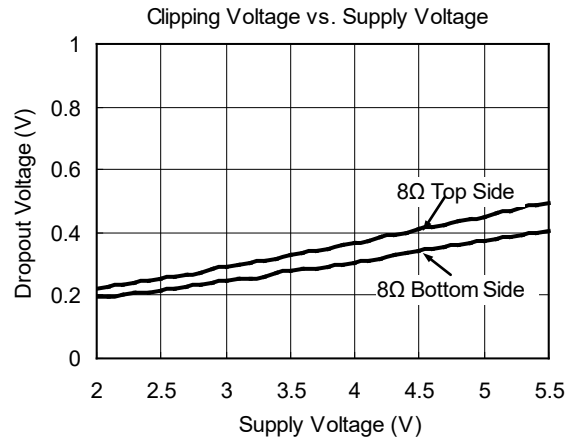
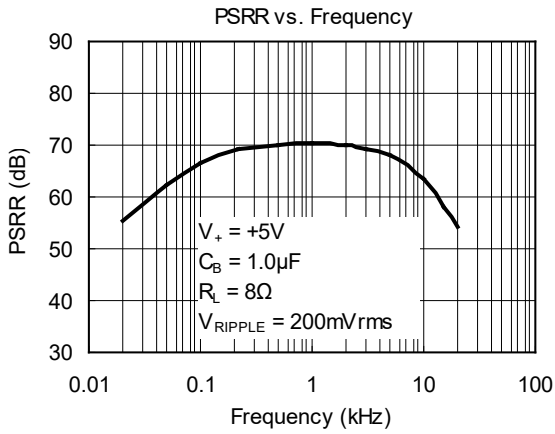

PACKAGE OUTLINE DIMENSIONS

SOIC-8

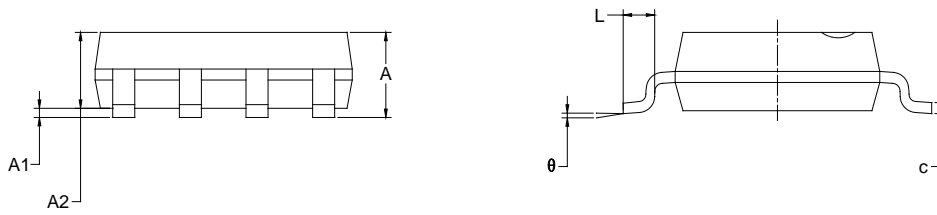
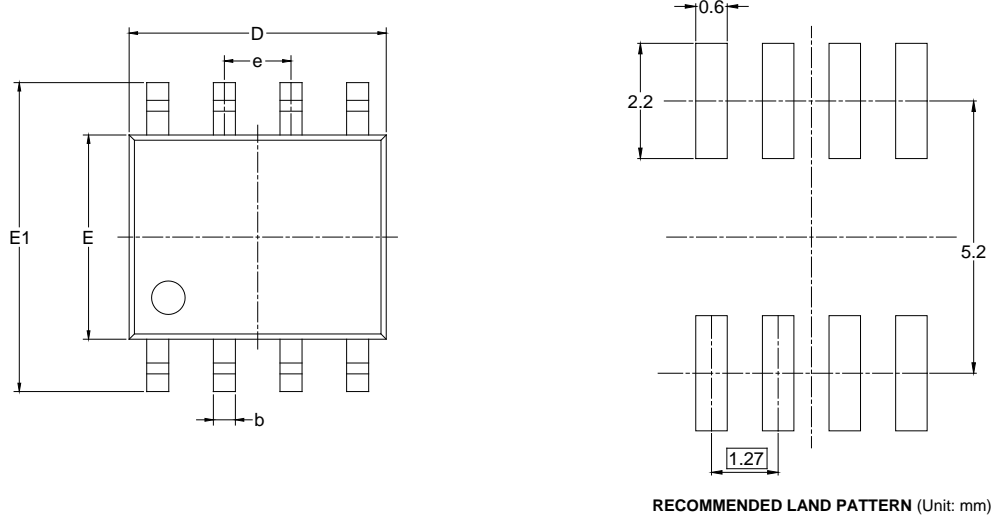

Symbol	Dimensions In Millimeters		Dimensions In Inches	
	MIN	MAX	MIN	MAX
A	1.350	1.750	0.053	0.069
A1	0.100	0.250	0.004	0.010
A2	1.350	1.550	0.053	0.061
b	0.330	0.510	0.013	0.020
c	0.170	0.250	0.006	0.010
D	4.700	5.100	0.185	0.200
E	3.800	4.000	0.150	0.157
E1	5.800	6.200	0.228	0.244
e	1.27 BSC		0.050 BSC	
L	0.400	1.270	0.016	0.050
θ	0°	8°	0°	8°

NOTES:
 1. Body dimensions do not include mode flash or protrusion.
 2. This drawing is subject to change without notice.

PACKAGE OUTLINE DIMENSIONS

SOIC-8 (Exposed Pad)

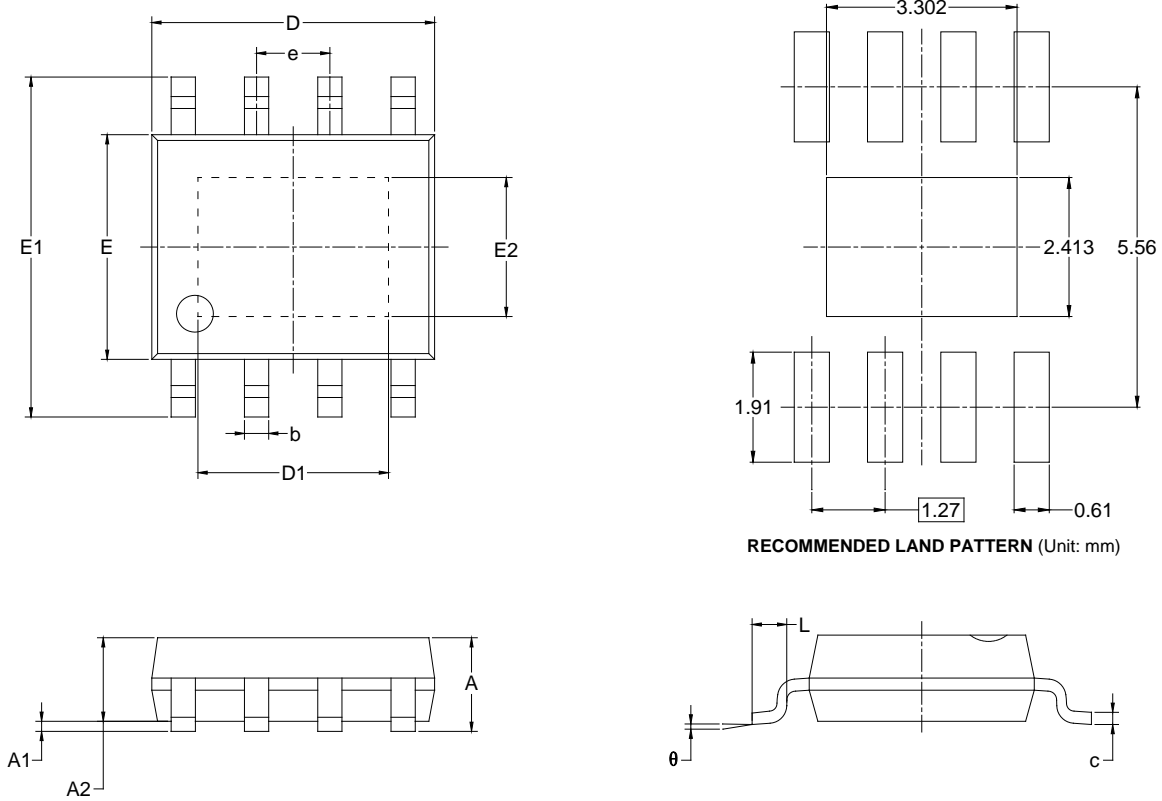

RECOMMENDED LAND PATTERN (Unit: mm)

Symbol	Dimensions In Millimeters		Dimensions In Inches	
	MIN	MAX	MIN	MAX
A		1.700		0.067
A1	0.000	0.100	0.000	0.004
A2	1.350	1.550	0.053	0.061
b	0.330	0.510	0.013	0.020
c	0.170	0.250	0.007	0.010
D	4.700	5.100	0.185	0.201
D1	3.202	3.402	0.126	0.134
E	3.800	4.000	0.150	0.157
E1	5.800	6.200	0.228	0.244
E2	2.313	2.513	0.091	0.099
e	1.27 BSC		0.050 BSC	
L	0.400	1.270	0.016	0.050
θ	0°	8°	0°	8°

NOTES:
 1. Body dimensions do not include mode flash or protrusion.
 2. This drawing is subject to change without notice.

TAPE AND REEL INFORMATION

REEL DIMENSIONS

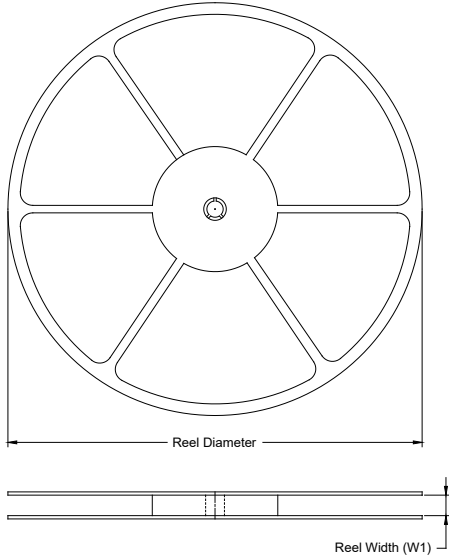

TAPE DIMENSIONS

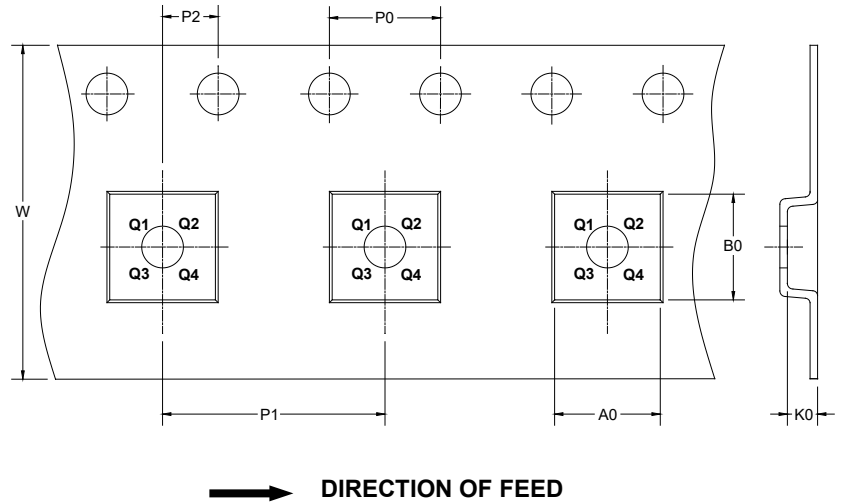

NOTE: The picture is only for reference. Please make the object as the standard.

KEY PARAMETER LIST OF TAPE AND REEL

Package Type	Reel Diameter	Reel Width W1 (mm)	A0 (mm)	B0 (mm)	K0 (mm)	P0 (mm)	P1 (mm)	P2 (mm)	W (mm)	Pin1 Quadrant
SOIC-8	13"	12.4	6.40	5.40	2.10	4.0	8.0	2.0	12.0	Q1
SOIC-8 (Exposed Pad)	13"	12.4	6.40	5.40	2.10	4.0	8.0	2.0	12.0	Q1

000001

PACKAGE INFORMATION

CARTON BOX DIMENSIONS

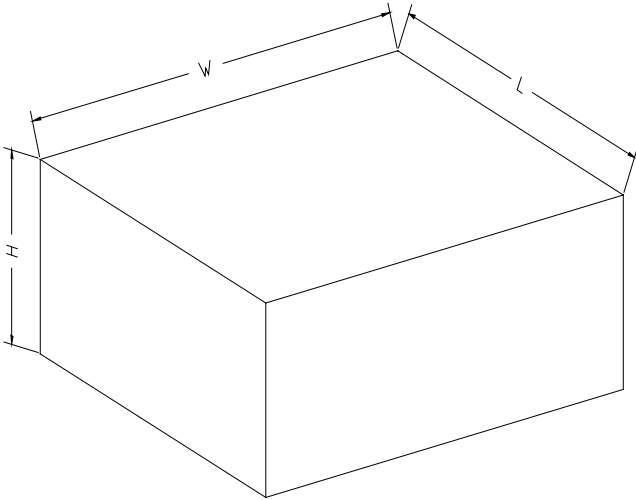

NOTE: The picture is only for reference. Please make the object as the standard.

KEY PARAMETER LIST OF CARTON BOX

Reel Type	Length (mm)	Width (mm)	Height (mm)	Pizza/Carton
13"	386	280	370	5

DD0002