

General Description

The MIC5204 is an active terminator designed to comply with SCSI-II specifications. The MIC5204 is enabled by a CMOS or TTL compatible logic signal. When disabled, power consumption drops nearly to zero and the output goes into a high impedance state. Key MIC5204 features include protection against reversed battery, current limiting, and over-temperature shutdown.

Features

- $\pm 1\%$ output voltage accuracy
- Guaranteed 500mA output
- Low quiescent current
- Low dropout voltage
- Extremely tight load and line regulation
- Very low temperature coefficient
- Current and thermal limiting
- Zero off-mode current
- Logic-controlled electronic shutdown
- Available in SO-8 and SOT-223 packages

Applications

- SCSI-II active terminator
- Desktop, laptop, notebook, and palmtop computers
- Intelligent instrumentation
- Printers
- Disk drives
- Voltage reference

Ordering Information

Part Number	Junction Temp. Range	Package
MIC5204BM	-40°C to +125°C	SO-8
MIC5204BS	-40°C to +125°C	SOT-223

Pin Configuration

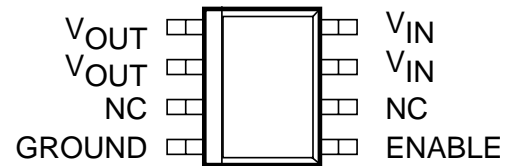

MIC5204BM

Typical Application

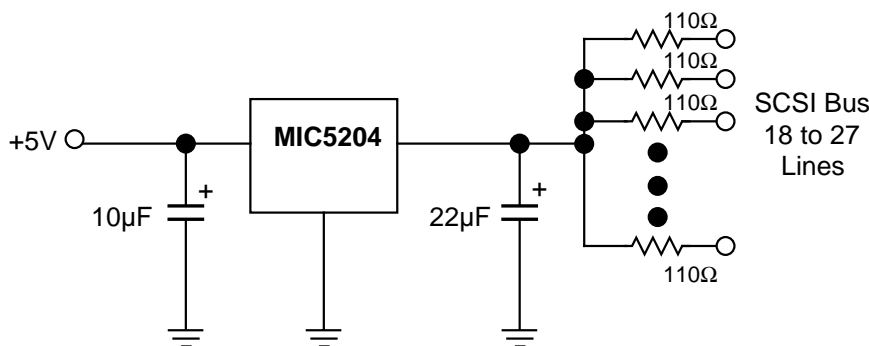

Both V_{IN} and both V_{OUT} pins must be tied together. ENABLE must be pulled high for operation.

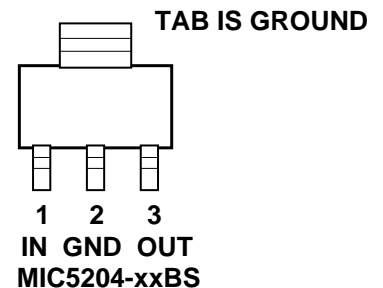

Absolute Maximum Ratings (Note 1)

Input Voltage (V_{IN})	-20V to +20V
Enable Input Voltage (V_{EN})	-0.3V to +20V
Power Dissipation (P_D)	Internally Limited, Note 3
Lead Temperature (soldering, 5 sec.)	260°C
ESD Rating	>2000V

Operating Ratings (Note 2)

Input Voltage (V_{IN})	+3V to +6V
Enable Input Voltage (V_{EN})	-0.3V to V_{IN}
Junction Temperature Range (T_J)	-40°C to +125°C

Electrical Characteristics

$V_{IN} = V_{OUT} + 1V$; $I_L = 1mA$; $C_L = 3.3\mu F$; $V_{EN} \geq 2.0V$; $T_J = 25^\circ C$, **bold** values indicate $-40^\circ C \leq T_J \leq +125^\circ C$; unless noted.

Symbol	Parameter	Conditions	Min	Typical	Max	Units
V_O	Output Voltage Accuracy		2.821 2.793	2.85	2.87 2.907	V
$\Delta V_O/\Delta T$	Output Voltage Temperature Coef.	Note 4		20	100	ppm/°C
$\Delta V_O/V_{IN}$	Line Regulation	$V_{IN} = V_{OUT} + 1V$ to 6V		0.004	0.10 0.40	%
$\Delta V_O/I_L$	Load Regulation	$I_L = 0.1mA$ to 100mA, Note 5		0.04	0.16 0.30	%
$V_{IN}-V_O$	Dropout Voltage, Note 6	$I_L = 100\mu A$ $I_L = 50mA$ $I_L = 100mA$ $I_L = 500mA$		30 75 190 240 210 350 450 750		mV
I_Q	Quiescent Current	$V_{ENABLE} \leq 0.7V$ (Shutdown)		0.01		μA
I_{GND}	Ground Pin Current	$V_{ENABLE} \geq 2.0V$, $I_L = 100\mu A$ $I_L = 20mA$ $I_L = 30mA$ $I_L = 50mA$ $I_L = 100mA$		130 240 300 450 900		μA
PSRR	Ripple Rejection			70		dB
I_{GNDDO}	Ground Pin Current at Dropout	$V_{IN} = 0.5V$ less than designed V_{OUT} $I_L = 100\mu A$, Note 7		270	330	μA
I_{LIMIT}	Current Limit	$V_{OUT} = 0V$		750		mA
$\Delta V_O/\Delta P_D$	Thermal Regulation	Note 8		0.05		%/W
e_n	Output Noise			30		μV

Enable Input

V_{IL}	Input Voltage Level Logic Low Logic High	off on	2.0		0.7	V
I_{IL} I_{IH}	Enable Input Current	$V_{IL} \leq 0.7V$ $V_{IH} \geq 2.0V$		0.01 15	50	μA

- Note 1.** Exceeding the absolute maximum rating may damage the device.
- Note 2.** The device is not guaranteed to function outside its operating rating.
- Note 3.** The maximum allowable power dissipation is a function of the maximum junction temperature, $T_{J(max)}$, the junction-to-ambient thermal resistance, θ_{JA} , and the ambient temperature, T_A . The maximum allowable power dissipation at any ambient temperature is calculated using: $P_{(max)} = (T_{J(max)} - T_A) \theta_{JA}$. Exceeding the maximum allowable power dissipation will result in excessive die temperature, and the regulator will go into thermal shutdown. The θ_{JC} of the MIC5204BS is 15°C/W and θ_{JA} for the MIC5204BM is 160°C/W mounted on a PC board (see "Thermal Considerations" for details).
- Note 4.** Output voltage temperature coefficient is defined as the worst case voltage change divided by the total temperature range.
- Note 5.** Regulation is measured at constant junction temperature using low duty cycle pulse testing. Parts are tested for load regulation in the load range from 0.1mA to 100mA. Changes in output voltage due to heating effects are covered by the thermal regulation specification.
- Note 6.** Dropout Voltage is defined as the input to output differential at which the output voltage drops 2% below its nominal value measured at 1V differential.
- Note 7.** Ground pin current is the regulator quiescent current plus pass transistor base current. The total current drawn from the supply is the sum of the load current plus the ground pin current.
- Note 8.** Thermal regulation is defined as the change in output voltage at a time "t" after a change in power dissipation is applied, excluding load or line regulation effects. Specifications are for a 500mA load pulse at $V_{IN} = 6V$ for $t = 10ms$.

Typical Characteristics

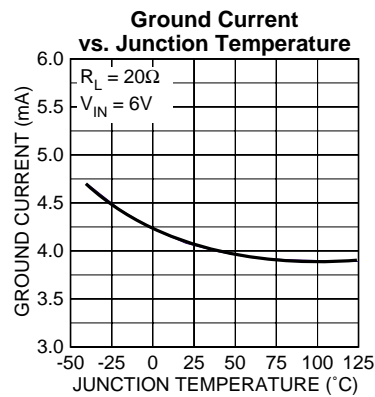
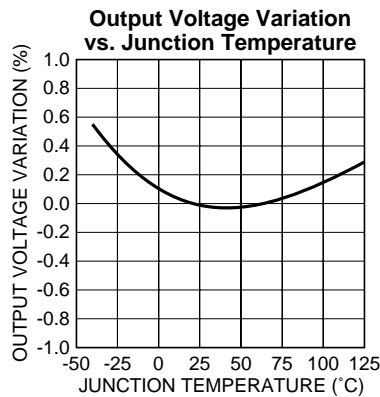

Applications Information

External Capacitors

A 2.2 μ F capacitor is recommended between the MIC5204 output and ground to prevent oscillations due to instability. Larger values serve to improve the regulator's transient response. Most types of tantalum or aluminum electrolytics will be adequate; film types will work. Many aluminum electrolytics have electrolytes that freeze at about -30°C , so solid tantalums are recommended for operation below -25°C . The important parameters of the capacitor are an effective series resistance of about 5Ω or less and a resonant frequency above 500kHz. The value of this capacitor may be increased without limit.

A 1 μ F capacitor should be placed from the MIC5204 input to ground if there is more than 10 inches of wire between the input and the AC filter capacitor or if a battery is used as the input.

The MIC5204 will remain stable and in regulation with no load in addition to the internal voltage divider.

Thermal Considerations

Part I. Layout

The MIC5204BM (8-pin surface mount package) has the following thermal characteristics when mounted on a single layer copper-clad printed circuit board.

PC Board Dielectric	θ_{JA}
FR4	160 $^{\circ}\text{C}/\text{W}$
Ceramic	120 $^{\circ}\text{C}/\text{W}$

Multi-layer boards having a ground plane, wide traces near the pads, and large supply bus lines provide better thermal conductivity. The "worst case" value of 160 $^{\circ}\text{C}/\text{W}$ assumes no ground plane, minimum trace widths, and a FR4 material board.

Part II. Nominal Power Dissipation and Die Temperature

The MIC5204BM at a 25 $^{\circ}\text{C}$ ambient temperature will operate reliably at up to 625mW power dissipation when mounted in the "worst case" manner described above. At an ambient temperature of 55 $^{\circ}\text{C}$, the device may safely dissipate 440mW. These power levels are equivalent to a die temperature of 125 $^{\circ}\text{C}$, the recommended maximum temperature for non-military grade silicon integrated circuits. In normal SCSI terminator applications, the average power dissipation is very small and this minimum geometry heat sink is suitable. The total dissipation does not approach the 400mW to 625mW range described above.

For MIC5204BS (SOT-223 package) heat sink characteristics, please refer to Micrel Application Hint 17, "P.C. Board Heat Sinking". As with the SO-8, average power dissipation in SCSI terminator applications is low and a minimum pad size is generally adequate.

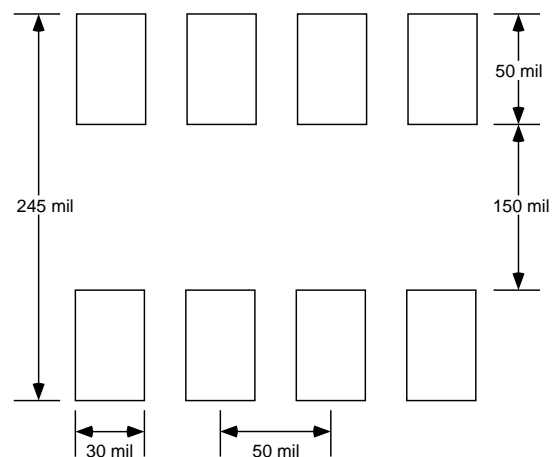

Minimum recommended board pad size, SO-8.

Package Information

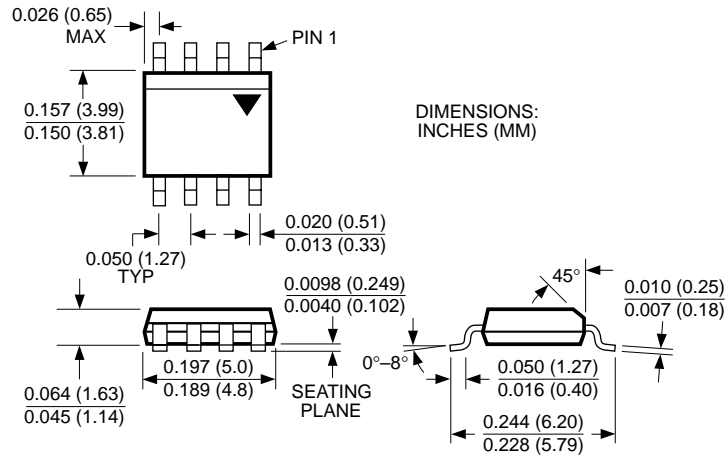

8-Pin SOP (M)

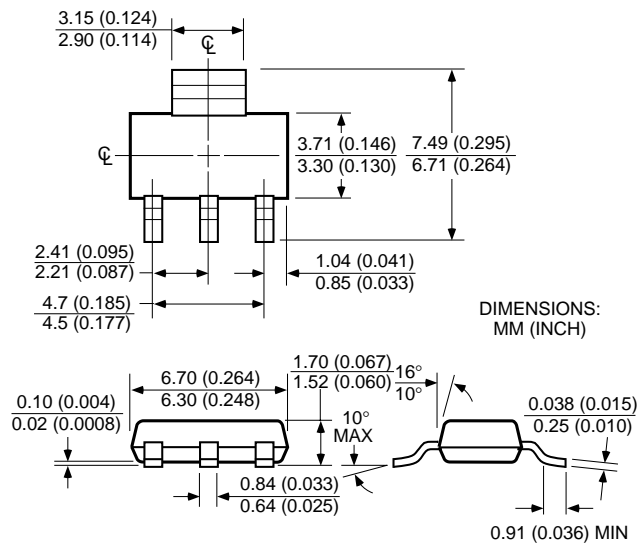

SOT-223 (S)

MICREL INC. 1849 FORTUNE DRIVE SAN JOSE, CA 95131 USA

TEL + 1 (408) 944-0800 FAX + 1 (408) 944-0970 WEB <http://www.micrel.com>

This information is believed to be accurate and reliable, however no responsibility is assumed by Micrel for its use nor for any infringement of patents or other rights of third parties resulting from its use. No license is granted by implication or otherwise under any patent or patent right of Micrel Inc.

© 1999 Micrel Incorporated