

The history of revision change for the specification

Document	REV.	Modified date	Description
CYNVC-175-018	A0	2017.5.31	New Approval
CYNVC-175-018	A1	2017.6.19	1. May -> Jun. 2. Remove spec of 101 3. Remove curve of 101 4. Add spec of 120
CYNVC-175-018	A2	2017.11.13	1. Add curve of 120 2. Jun. -> Nov.
CYNVC-175-018	A3	2018.3.13	1. Add "AEC-Q200" logo on page 2 2. Nov., 2017 -> Mar., 2018 3. Year code 2017 = 7 -> 2018 = 8
CYNVC-175-018	A4	2018.6.15	1. Mar. -> Jun. 2. Add spec of R22 3. Add curve of R22
CYNVC-175-018	A5	2018.11.13	1. Jun. -> Nov. 2. Remove spec & curve of R22, 120
CYNVC-175-018	A6	2019.9.16	1. Nov., 2018 -> Sep., 2019 2. Add spec & curve of 101
CYNVC-175-018	A7	2020.1.21	1. Sep., 2019 -> Jan., 2020 2. Year code 2019 = 9 -> 2020 = 0
CYNVC-175-018	A8	2020.6.15	1. Jan. -> Jun. 2. Add spec and curve of R68 3. Add rated voltage
CYNVC-175-018	A9	2020.9.9	1. Jun. -> Sep. 2. Update Land Pattern A: 4.95 -> 5.0 ; B: 5.4 -> 4.9 ; C: 13.6 -> 12.88
CYNVC-175-018	B0	2020.12.1	1. Sep. -> Dec. 2. Add spec and curve of 1R5
CYNVC-175-018	B1	2022.12.23	1. Dec., 2020 -> Dec., 2022 2. Add spec and curve of 8R2

Power Choke Coil VCHA105D MS6 type

AEC-Q200

■ Features

High performance (Isat) realized by metal dust core.

Low profile : Thickness max. 5.4mm

Low loss realized with low DCR

Compliance with RoHS and Halogen Free

AEC-Q200 qualified

■ Application

Automotive applications

■ Outline Dimensions

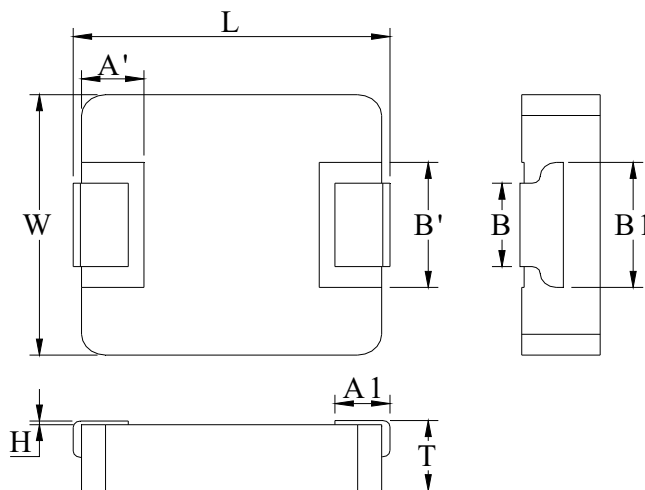

Code	Dimensions (mm)
L	10.85 ± 0.35
W	10.0 ± 0.3
T	5.2 ± 0.2
A1	2.2 ± 0.5
A'	2.5 ± 0.1
B	4.5 ± 0.3
B1	6.5 ± 0.3
B'	6.0 ± 0.3
H	0 ~ +0.15

■ Recommend Land Pattern Dimensions

The customer shall determine the land dimensions shown below after confirming and safety.

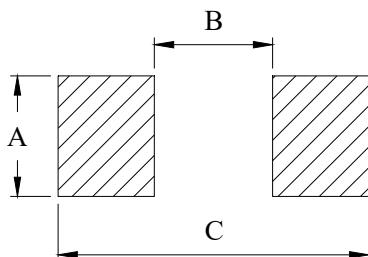

A	5.00
B	4.90
C	12.88

Unit : mm

■ Marking and Date Code

The point on the top surface represents winding direction of choke.

(1) Marking

The inductor is marked with a 3-digit code

Example -- $1.0\mu\text{H}$ → 1R0

(2) Date Code

X XX

(1) (2)

XXX

(3)

Where (1) Year Code

Ex : 2022 = 2

(2) Weekly Code

Serial number : 01 ~ 53

(3) Taping No.

Serial number : 001 ~ ZZZ

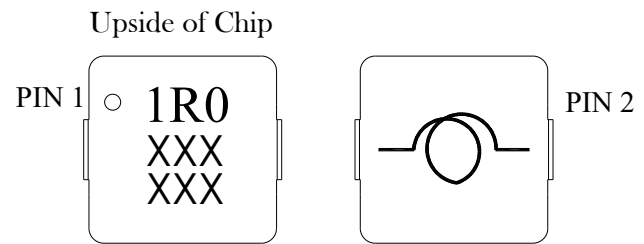

■ Specifications

Part Number	L0 ◇ Inductance (μH) @ (0A)	R _{dc} (m Ω) ◇		Heat Rating Current DC Amps. I _{dc} (A)		Saturation Current DC Amps. I _{sat} (A)		Rated Voltage (V)
		Typical	Maximum	Typical	Maximum	Typical	Maximum	Maximum
VCHA105D-R68MS6	0.68	1.85	2.22	32.0	28.8	46.0 ^{Note 5}	39.4 ^{Note 5}	80
VCHA105D-1R0MS6	1.0	2.30	2.76	30.0	27.0	37.0	31.7	80
VCHA105D-1R5MS6	1.5	3.50	4.20	24.8	22.3	26.8	23.0	80
VCHA105D-2R2MS6	2.2	4.1	4.9	23.0	20.7	25.0	21.4	80
VCHA105D-3R3MS6	3.3	6.2	7.4	18.7	16.8	19.0	16.3	80
VCHA105D-4R7MS6	4.7	8.3	10.0	14.5	13.0	15.7	13.5	80
VCHA105D-6R8MS6	6.8	12.0	14.0	12.0	10.8	13.3	11.4	80
VCHA105D-8R2MS6	8.2	18.0	20.7	10.6	9.5	13.0	11.1	80
VCHA105D-100MS6	10.0	21.0	24.2	8.7	7.8	12.7	10.9	80
VCHA105D-150MS6	15.0	27.2	31.3	7.6	6.8	9.2	7.9	80
VCHA105D-220MS6	22.0	43.5	50.0	6.0	5.4	8.8	7.5	80
VCHA105D-330MS6	33.0	65.5	75.3	4.8	4.3	7.6	6.5	80
VCHA105D-470MS6	47.0	89.0	103.0	4.1	3.6	4.9	4.2	80
VCHA105D-680MS6	68.0	132.0	152.0	3.3	3.0	4.2	3.6	80
VCHA105D-101MS6	100.0	203.0	234.0	2.8	2.5	3.5	3.0	55

◇ : Significant Characteristic

* : If you require another part number please contact with us.

** : Inductance Tolerance $\pm 20\%$

Note 1. : All test data is referenced to 25°C ambient.

Note 2. : Test Condition: 100KHz, 1.0Vrms

Note 3. : I_{dc} : DC current (A) that will cause an approximate ΔT of 40°C

Note 4. : I_{sat} : DC current (A) that will cause L0 to drop approximately 30%

Note 5. : I_{sat} : DC current (A) that will cause L0 to drop approximately 35%

Note 6. : Operating Temperature Range -55°C to +165°C

Note 7. : The part temperature (ambient + temp rise) should not exceed 165°C under the worst case operating conditions. Circuit design, component placement, PCB trace size and thickness, airflow and other cooling provision all affect the part temperature. Part temperature should be verified in the end application.

Note 8. : The rated current as listed is either the saturation current or the heating current depending on which value is lower.

Note 9. : Cleaning Process Note

(a) If this power choke is dipped in the cleaning agent, such as toluene, xylene, ketone, and ether system, there is a possibility that the performance decreases greatly

(b) The high power ultrasonic washing may damage the choke body.

(c) Please contact us if you need the cleaning via the above agents or ultrasonic washing.

Current Characteristic

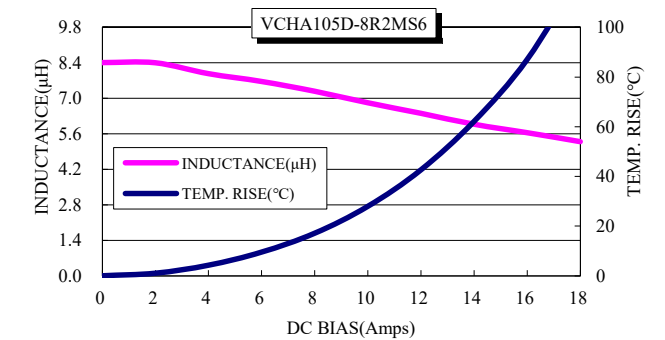
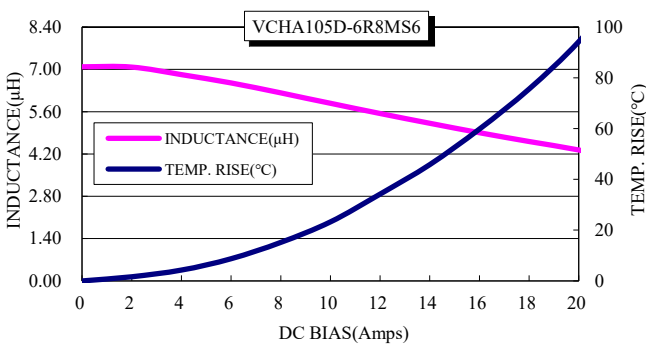
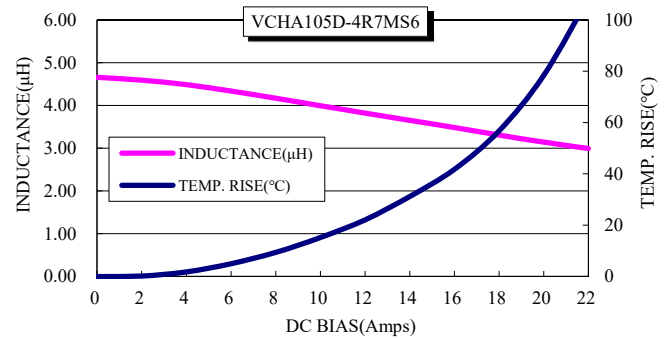
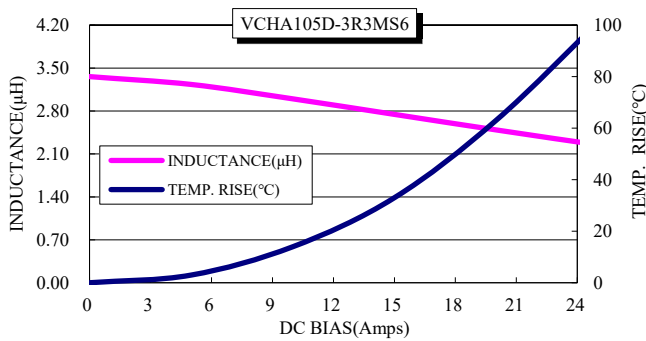
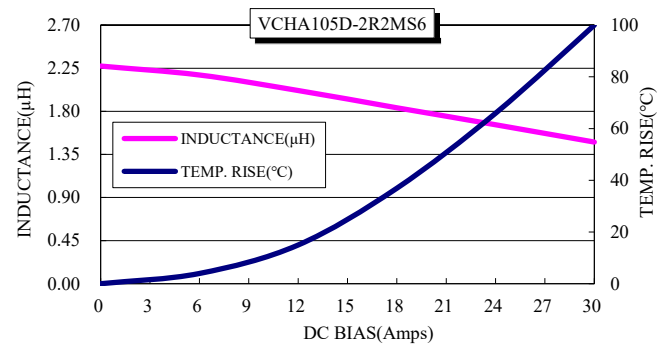
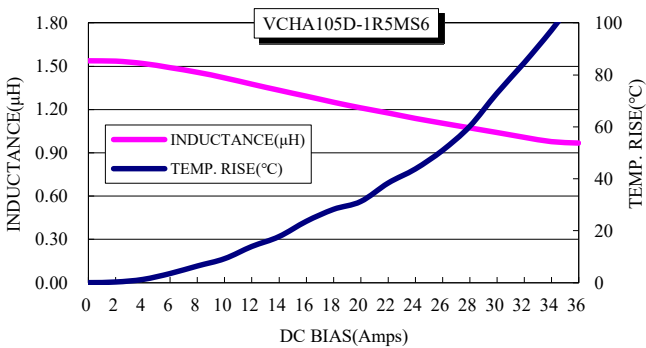
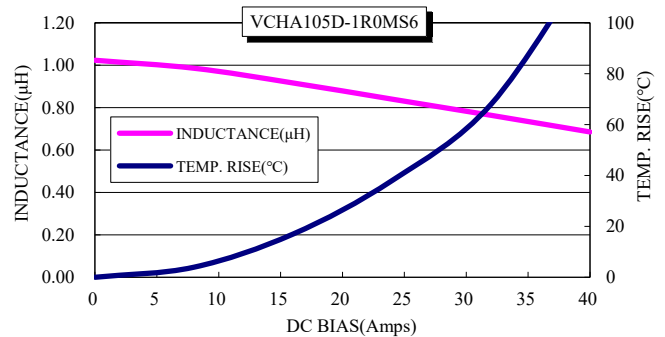
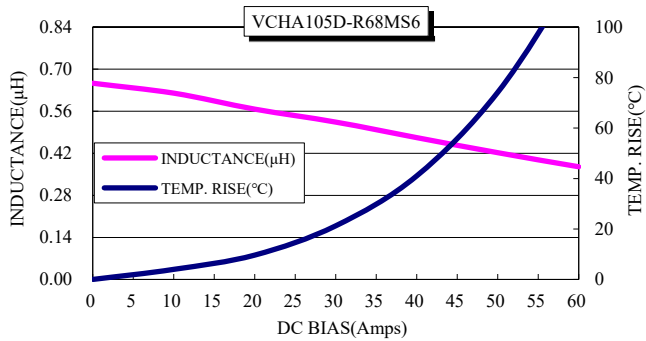

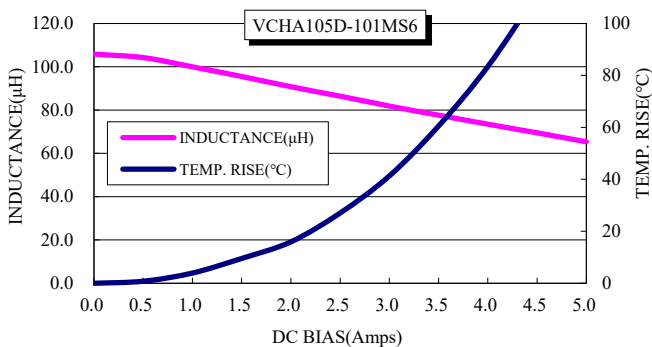
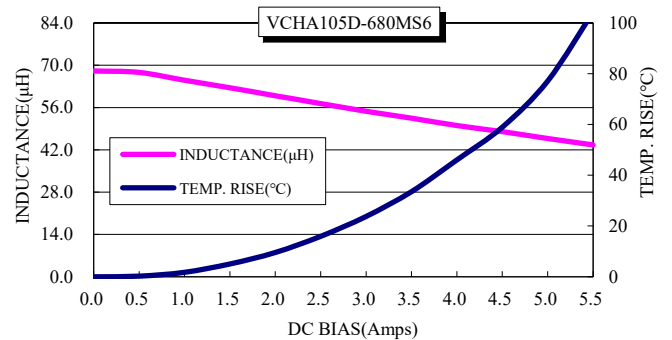
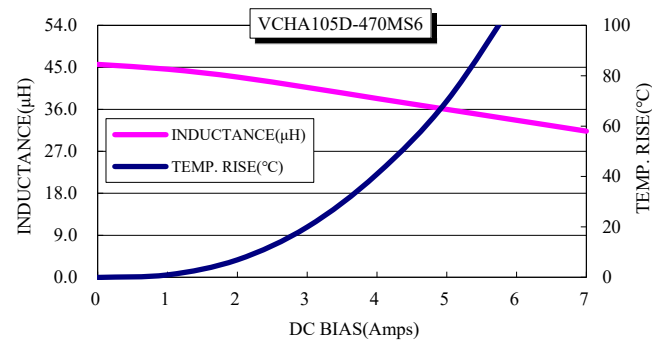
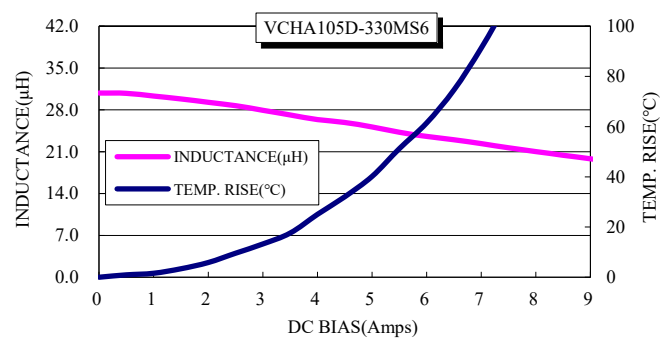
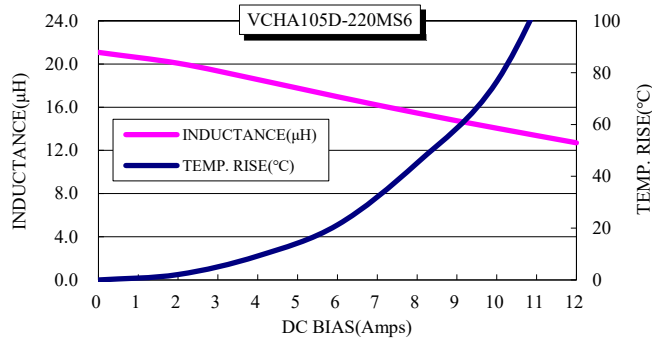
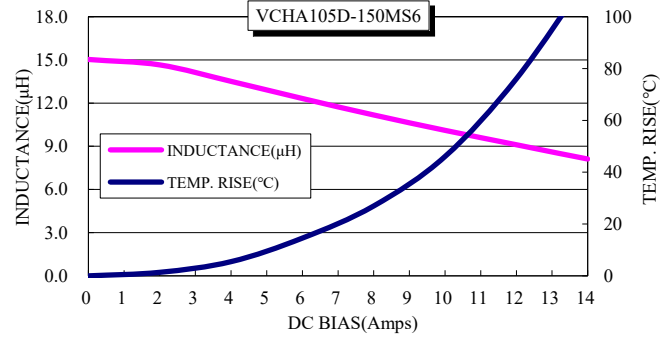
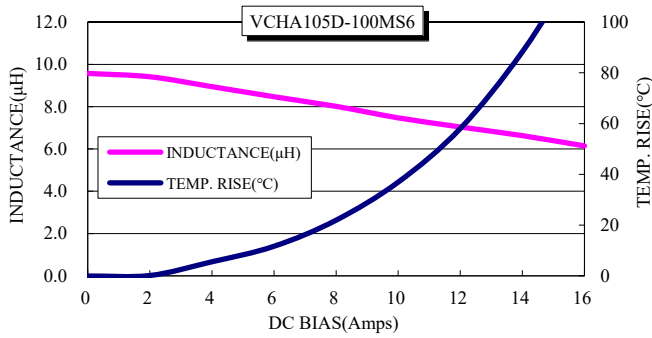

■ Packaging

(1) Tape packaging dimensions

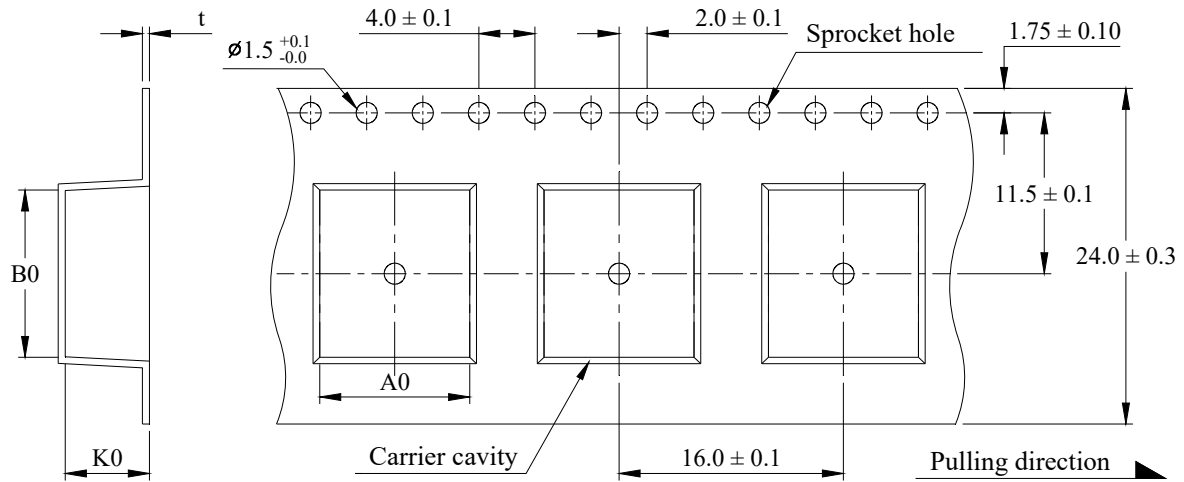

Dimensions Code (mm)				UNITS/REEL
A0	B0	K0	t	
10.7 ± 0.1	12.0 ± 0.1	6.0 ± 0.1	0.50 ± 0.05	500

(2) Tape Direction

The direction shall be seen from the top cover tape side.

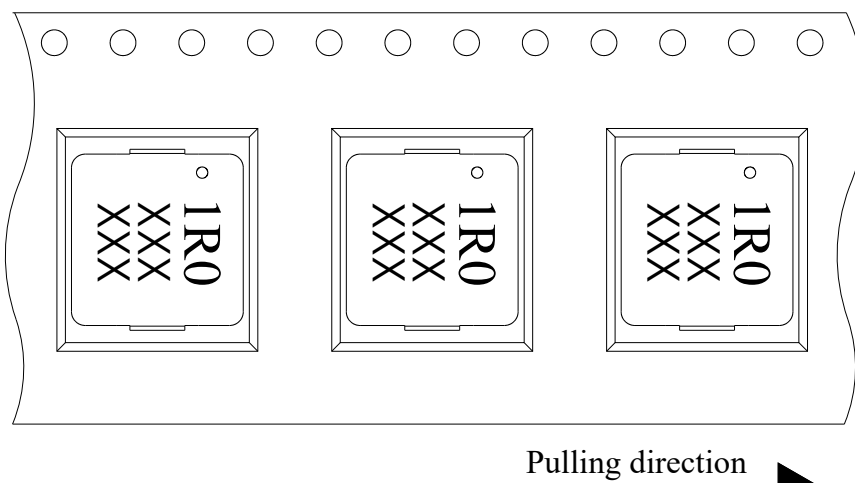

(3) Reel dimensions

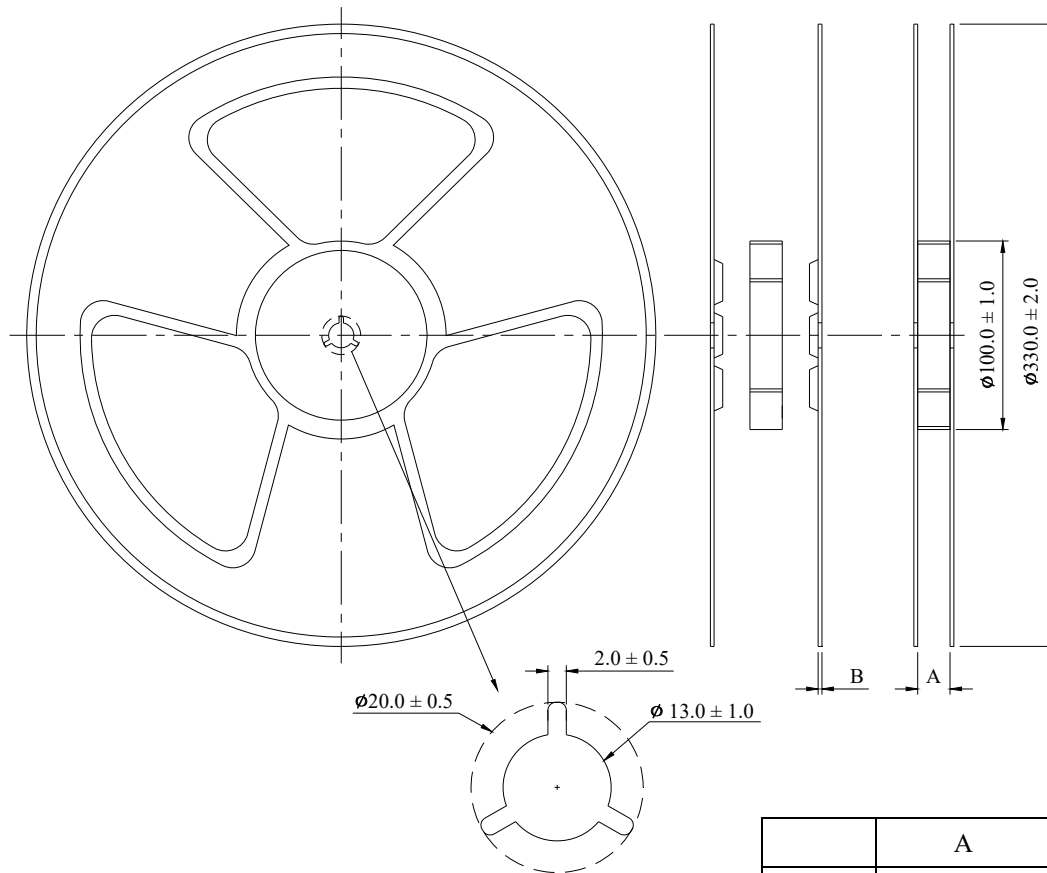

	A	B
mm	24.5 ± 0.5	2.0 ± 0.2

(4) Peel force of top cover tape

The peel speed shall be about 300 mm/minute.

The peel force of top cover tape shall be between 0.1 to 1.3N.

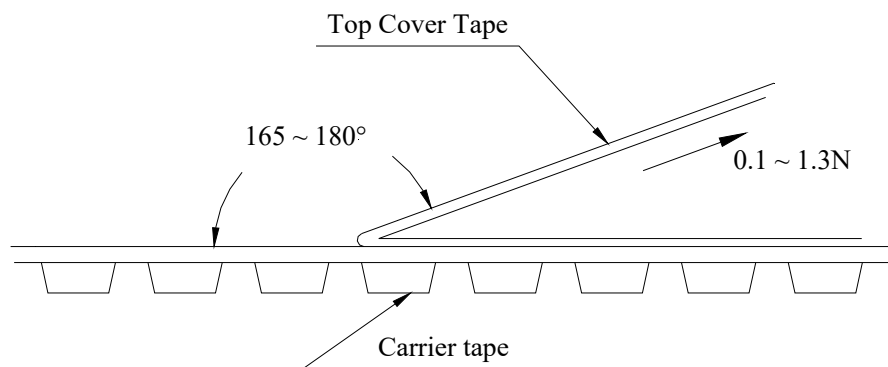

■ Reflow Profile

Power Choke Coil Type

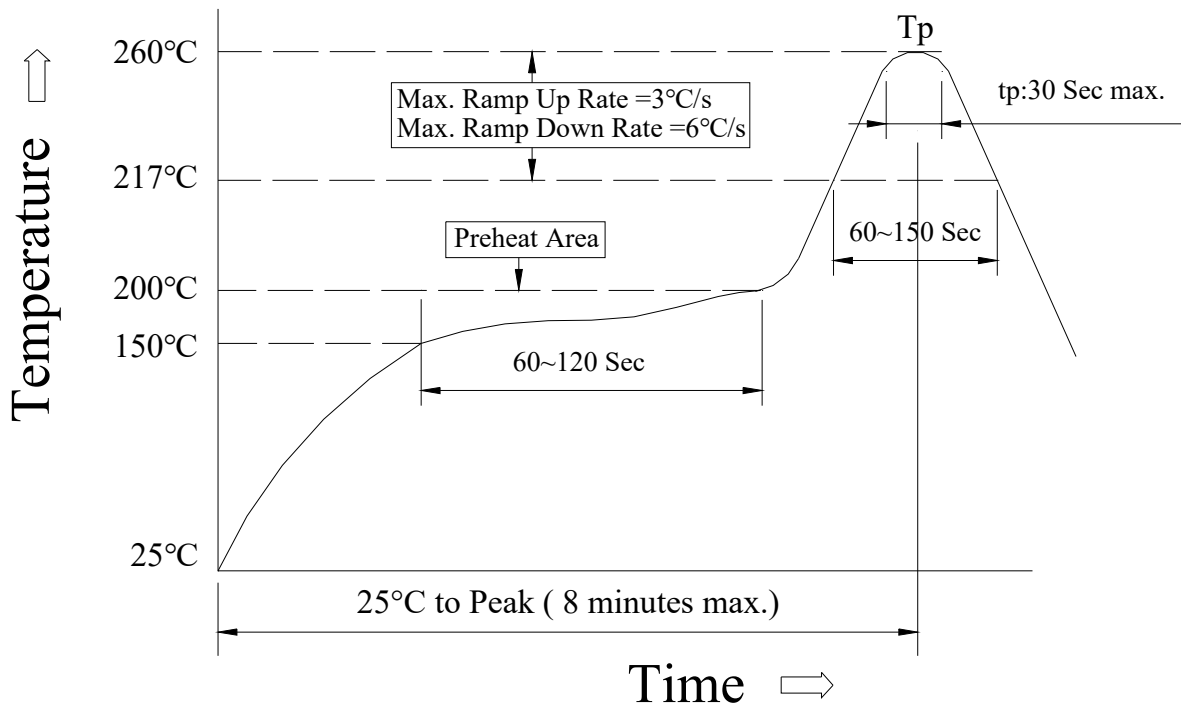

(1) Reflow Soldering Method :

Reflow Soldering	Tp:255~260°C	Max.30 seconds (tp)
	217°C	60~150 seconds
Pre-Heat	150 ~ 200°C	60~120 seconds
Time 25°C to peak temperature	8 minutes max.	

(2) Soldering iron Method : 350 ± 5°C max.3 seconds