

Evaluates: MAX38913, MAX38914

MAX38913A WLP Evaluation Kit

General Description

The MAX38913A WLP evaluation kit (EV kit) evaluates the MAX38913A in a wafer-level package (WLP). The MAX38913A is a low-noise linear regulator. The EV kit operates over an input range of 1.8V to 5.5V. The EV kit provides an output voltage that is jumper selectable between two separate levels. Each of the two regulated output levels are configured to one of the 33 possible voltages through external select resistors. The MAX38913A EV kit features a pass-through mode that can completely bypass the linear regulator. The EV kit can deliver up to 1A of current.

Features

- Evaluates the MAX38913A IC in a 12-Pin (3x4 0.4mm Pitch) WLP
- 1.8V to 5.5V Input Range
- 0.6V to 5.0V Resistor Configurable Output Voltages
- Jumper Selectable Between Two Output Voltages
- Input to Output Pass-Through Mode
- Up to 1A Output Current
- Proven 4-Layer 1-oz Copper PCB Layout
- Demonstrates Compact Solution Size
- Fully Assembled and Tested

MAX38913A WLP EV Kit Files

FILE	DESCRIPTION
MAX38913A WLP	EV Kit Bill of Materials
MAX38913A WLP	EV Kit Layout
MAX38913A WLP	EV Kit Schematic

[Ordering Information](#) appears at end of data sheet.

Quick Start

Required Equipment

- MAX38913A WLP EV Kit
- 1.8V to 5.5V, 3A DC power supply (IN)
- Electronic load capable of 1A
- Digital voltmeter (DVM)

Procedure

The EV kit is fully assembled and tested. Follow the steps below to verify the board operation.

Caution: Do not turn on power supply until all connections are completed.

- 1) Verify that jumper RSEL1 is opened (VSEL1 is set to 3.6V).
- 2) Verify that jumper RSEL2 is opened (VSEL2 is set to 1.8V).
- 3) Verify that jumpers EN2 and EN1 are shunted on pins 1 and 2 (OUT = VSEL2).
- 4) Connect the 5.5V power supply between the IN and nearest GND terminal posts.
- 5) Connect the 1A electronic load between the OUT and nearest GND terminal posts.
- 6) Connect the DVM between the OUT and nearest GND terminal posts.
- 7) Turn on the power supply.
- 8) Verify that the voltage at the OUT terminal post is 1.8V within the device and the RSEL resistors accuracy specifications.
- 9) Enable the electronic load.
- 10) Verify that the voltage at the OUT terminal post is 1.8V within the device and the RSEL resistors accuracy specifications.
- 11) Move the shunt on Jumper EN2 to pins 2 and 3, Jumper EN1 still shunt on pins 1 and 2, (OUT = VSEL1).
- 12) Verify that the voltage at the OUT terminal post is 3.6V within the device and the RSEL resistors accuracy specifications.

EV Kit Photo

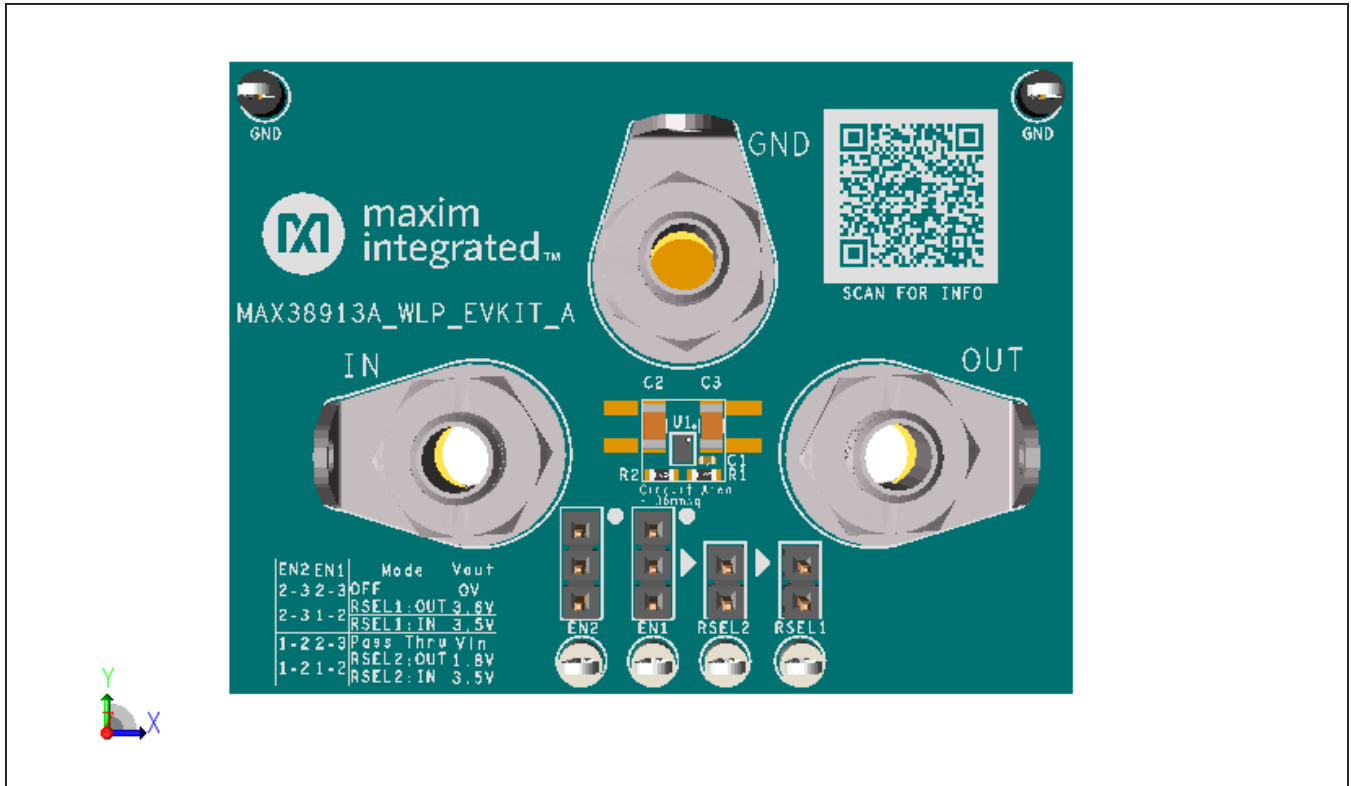

Detailed Description of Hardware

The MAX38913A WLP EV kit evaluates the MAX38913A in a WLP package. The MAX38913A is a low-noise linear regulator that delivers 1A of output current with only 4µVrms of output noise from 10Hz to 100kHz. The MAX38913A has a high power-supply rejection ratio (PSRR) of 70dB at 10Hz. This regulator requires only 33mV (typical) of input-to-output headroom at 3.6V output and full load.

The MAX38913A WLP EV kit comes with the MAX38913AANC+ installed. The EV kit operates over an input range of 1.8V to 5.5V and provides an output voltage that is jumper selectable between two different output levels. The input can be passed through to the output in a low quiescent current pass-through mode. Each of the two regulated output levels are configured to one of the 33 possible voltages through external select resistors.

EN1, EN2, RSEL1, and RSEL2 (Mode and Output Selection)

The EV kit provides four jumpers. The EN1 and EN2 jumpers select between four different modes. Jumpers RSEL1 and RSEL2 set the VSEL1 and VSEL2 output levels, respectively, of the MAX38913A EV kit. Refer to [Table 1](#) for jumpers EN1, EN2, RSEL1, and RSEL2 settings.

Table 1. EN1, EN2, RSEL1, and RSEL2

EN2	EN1	RSEL2	RSEL1	MODE	OUT [V]
2-3	2-3	Don't care	Don't care	OFF	0.0V
2-3	1-2		OPEN	VSEL1	3.6V
			1-2*		3.5V
1-2	2-3	Don't care	Don't care	Pass thru	IN
1-2*	1-2*	OPEN		VSEL2	1.8V
		1-2*			3.5V

*Default Position

Component Suppliers

SUPPLIER	WEBSITE
Murata/TOKO	www.murata.com
TDK	www.tdk.com

Note: Indicate that you are using the MAX38913A when contacting these component suppliers.

MAX38914 Evaluation

To evaluate MAX38914 using MAX38913AEVK#WLP, replace U1 with MAX38914AANC+ and remove resistors R1 and R2. The MAX38914 provides pre-programmed fixed output voltages of 2.0V and 2.3V.

Ordering Information

PART	TYPE
MAX38913AEVK#WLP	EV Kit

#Denotes RoHS compliance.

MAX38913A WLP EV Kit Bill of Materials

ITEM	REF_DES	QTY	MFG PART #	MANUFACTURER	DESCRIPTION
1	C1	1	C1005X7R1H473K; CGA2B3X7R1H473K050BB; GCM155R71H473KE02	TDK; TDK; MURATA	CAP; SMT (0402); 0.047UF; 10%; 50V; X7R; CERAMIC
2	C2	1	GCM31CR71A226KE02	MURATA	CAP; SMT (1206); 22UF; 10%; 10V; X7R; CERAMIC
3	C3	1	GRM31CR60J107KE39	MURATA	CAP; SMT (1206); 100UF; 10%; 6.3V; X5R; CERAMIC*
4	EN1, EN2	2	PEC03SAAN	SULLINS	CONNECTOR; MALE; THROUGH HOLE; BREAKAWAY; STRAIGHT; 3PINS
5	GND, IN, OUT	3	108-0740-001	EMERSON NETWORK POWER	CONNECTOR; MALE; PANELMOUNT; BANANA JACK; STRAIGHT; 1PIN
6	GND_1, GND_2	2	5006	KEYSTONE	TEST POINT; PIN DIA=0.125IN; TOTAL LENGTH=0.35IN; BOARD HOLE=0.063IN; BLACK; PHOSPHOR BRONZE WIRE SILVER PLATE FINISH;
7	R1	1	CRCW060347K5FK; ERJ-3EKF4752	VISHAY DALE; PANASONIC	RES; SMT (0603); 47.5K; 1%; +/- 100PPM/DEGC; 0.1000W
8	RSEL1, RSEL2	2	PEC02SAAN	SULLINS ELECTRONICS CORP.	EVKIT PART-CONNECTOR; MALE; THROUGH HOLE; BREAKAWAY; STRAIGHT; 2PINS;
9	SU1-SU4	4	S1100-B; SX1100-B; STC02SYAN	KYCON; KYCON; SULLINS ELECTRONICS CORP.	TEST POINT; JUMPER; STR; TOTAL LENGTH=0.24IN; BLACK; INSULATION=PBT; PHOSPHOR BRONZE CONTACT=GOLD PLATED
10	TP_EN1, TP_EN2, TP_RSEL1, TP_RSEL2	4	5007	KEYSTONE	TEST POINT; PIN DIA=0.125IN; TOTAL LENGTH=0.35IN; BOARD HOLE=0.063IN; WHITE; PHOSPHOR BRONZE WIRE SILVER PLATE FINISH;
11	U1	1	MAX38913AANC+	MAXIM	EVKIT PART - IC; MAX38913AANC+; 1A LOW NOISE LDO WITH DUAL VOLTAGE AND BYPASS; PACKAGE OUTLINE DRAWING: 21-100500; PACKAGE CODE: N121E1+1
12	PCB	1	MAX38913AWLP	MAXIM	PCB:MAX38913AWLP
13	R2	0	N/A	N/A	RESISTOR; 0603; OPEN; FORMFACTOR
Total		23			

*This capacitor was chosen to match a specific customer application. For applications in an extended temperature range, an X7R capacitor is required.

MAX38913A WLP EV Kit Schematic

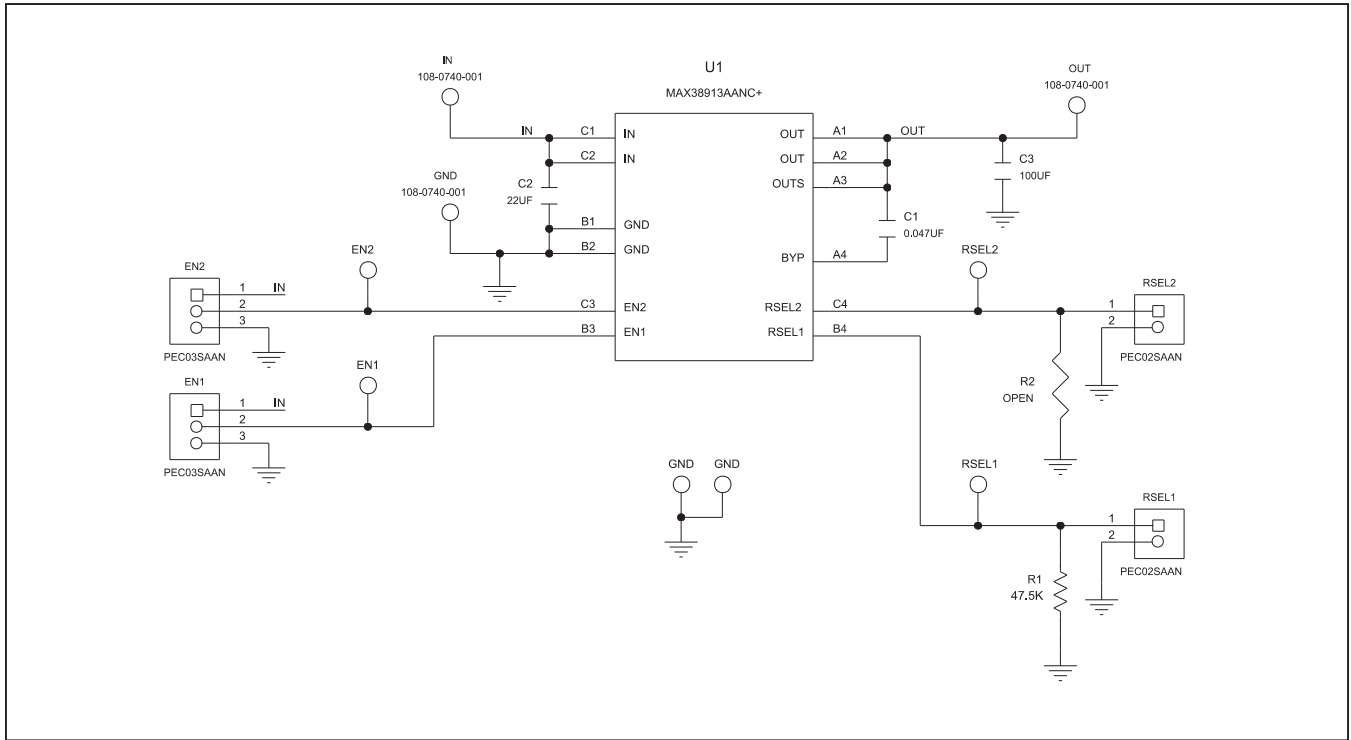

MAX38913A WLP EV Kit PCB Layout

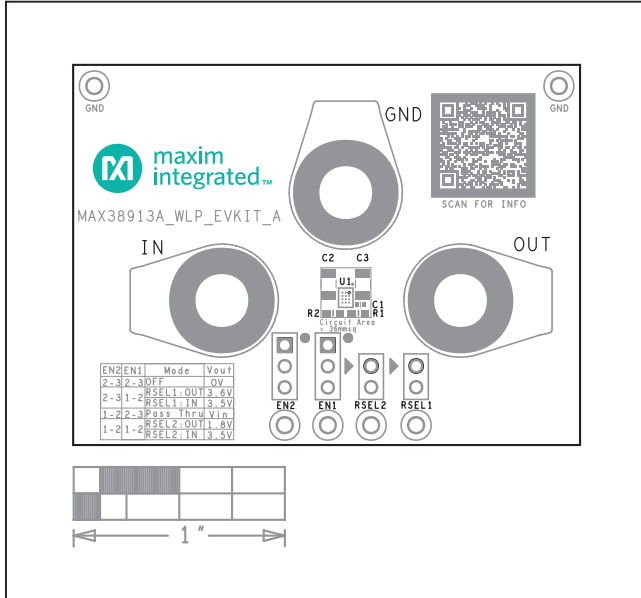

MAX38913A WLP EV Kit Component Placement Guide—Top Silkscreen

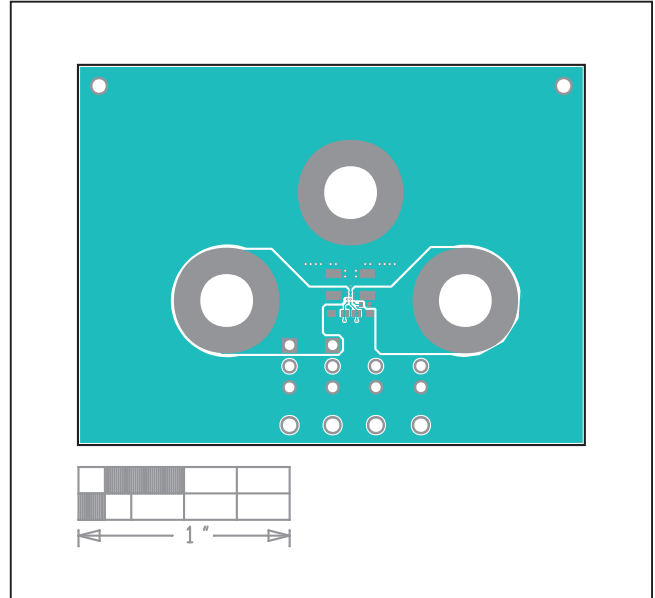

MAX38913A WLP EV Kit PCB Layout—Top

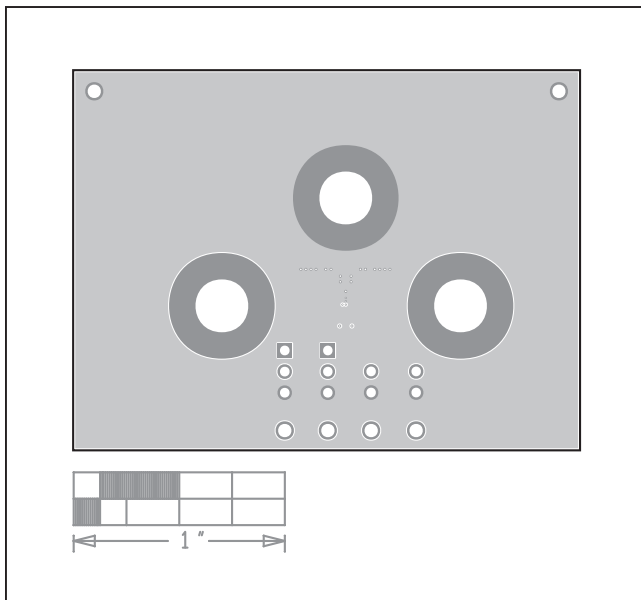

MAX38913A WLP EV Kit PCB Layout—Layer 2

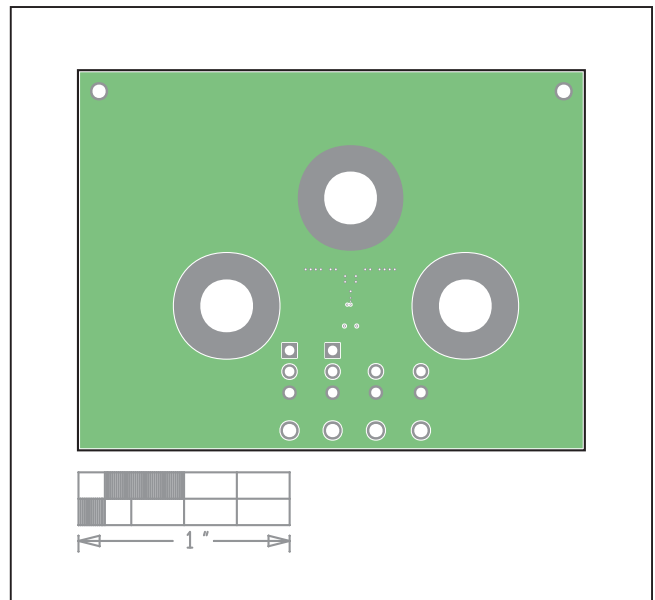

MAX38913A WLP EV Kit PCB Layout—Layer 3

MAX38913A WLP EV Kit PCB Layout (continued)

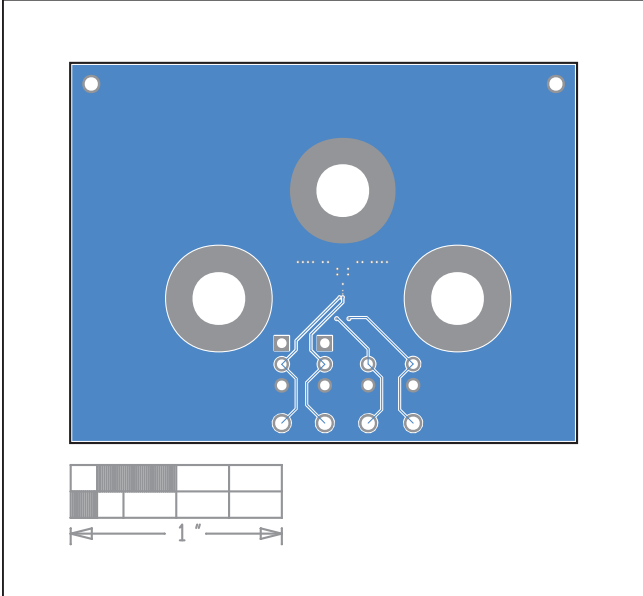

MAX38913A WLP EV Kit PCB Layout—Bottom

Revision History

REVISION NUMBER	REVISION DATE	DESCRIPTION	PAGES CHANGED
0	3/21	Initial release	—
1	7/23	Updated EV kit title and added MAX38914 Evaluation section	1–8

