

NBC-FS/10,0-94B/R4MC SCO - Network cable



1407454

<https://www.phoenixcontact.com/us/products/1407454>

Please be informed that the data shown in this PDF document is generated from our online catalog. Please find the complete data in the user documentation. Our general terms of use for downloads are valid.



Network cable, Ethernet CAT5 (1 Gbps), 8-position, PUR halogen-free, water blue RAL 5021, shielded, Plug straight RJ45 Clip locking / IP67, on Socket straight M12 SPEEDCON, coding: A / IP67, cable length: 10 m

Commercial data

Item number	1407454
Packing unit	1 pc
Minimum order quantity	1 pc
Sales key	BF04
Product key	BF1CMI
Catalog page	Page 401 (C-2-2019)
GTIN	4046356775755
Weight per piece (including packing)	509.6 g
Weight per piece (excluding packing)	509.6 g
Customs tariff number	85444210
Country of origin	PL

1407454

<https://www.phoenixcontact.com/us/products/1407454>

Technical data

Notes

General	Further products with variable cable type and variable cable length can be found in the accessories section
---------	---

Product properties

Product type	Data cable preassembled
Application	Standard
Sensor type	Ethernet
Number of positions	8
Shielded	yes
Coding	A

Interfaces

Bus system	Ethernet
Signal type/category	Ethernet CAT5 (based on IEC 11801), 1 Gbps

Signaling

Status display	No
Status display present	No

Electrical properties

Nominal voltage U_N	30 V AC
	30 V DC
Nominal current I_N	1 A
Transmission medium	Copper
Transmission characteristics (category)	CAT5 (IEC 11801:2002)

Material specifications

Seal material	NBR
---------------	-----

Connector

Connection 1

Type	Plug straight RJ45 Clip locking / IP67
Number of positions	8 (8)
Locking type	Clip locking
Handle color	gray
Material	CuSn (Contact)
	Ni/Au (Contact surface)
	PC (Contact carriers)
	PA (Housing)
Insertion/withdrawal cycles	≥ 750
Degree of protection	IP67

NBC-FS/10,0-94B/R4MC SCO - Network cable



1407454

<https://www.phoenixcontact.com/us/products/1407454>

Ambient temperature (operation)	-20 °C ... 70 °C
---------------------------------	------------------

Connection 2

Type	Socket straight M12 SPEEDCON / IP67
Number of positions	8
Locking type	SPEEDCON
Coding type	A (Standard)
Handle color	black
Material	CuZn (Contact) Ni/Au (Contact surface) TPU GF (Contact carriers) TPU, hardly inflammable, self-extinguishing (Grip) Zinc die-cast, nickel-plated (Screw connection)
Insertion/withdrawal cycles	≥ 100
Insulation resistance	≥ 100 MΩ
Tightening torque	0.4 Nm
Degree of protection	IP67
Ambient temperature (operation)	-25 °C ... 90 °C

Cable/line

Cable length	10 m
--------------	------

Ethernet flexible CAT5, 4-pair [94B]

Dimensional drawing	
Cable weight	47 kg/km
UL AWM Style	20963 (80°C/30 V)
Number of positions	8
Shielded	yes
Cable type	Ethernet flexible CAT5, 4-pair [94B]
Conductor structure	4x2xAWG26/7, SF/UTP
Signal runtime	5.3 ns/m
Conductor structure signal line	7x 0.16 mm
AWG signal line	26
Conductor cross section	4x 2x 0.14 mm ²
Wire diameter incl. insulation	0.96 mm
External cable diameter	6.40 mm ±0.2 mm
Outer sheath, material	PUR
External sheath, color	water blue RAL 5021

NBC-FS/10,0-94B/R4MC SCO - Network cable



1407454

<https://www.phoenixcontact.com/us/products/1407454>

Conductor material	Bare Cu litz wires
Material wire insulation	Foamed PE
Single wire, color	white/blue-blue, white/orange-orange, white/green-green, white/brown-brown
Thickness, outer sheath	1.05 mm
Twisted pairs	2 cores to the pair
Overall twist	4 pairs for core
Optical shield covering	70 %
Insulation resistance	$\geq 5 \text{ G}\Omega \cdot \text{km}$
Coupling resistance	$\leq 100.00 \text{ m}\Omega/\text{m}$ (at 10 MHz)
Loop resistance	$\leq 290.00 \text{ }\Omega/\text{km}$
Wave impedance	$100 \text{ }\Omega \pm 5 \text{ }\Omega$ (at 100 MHz)
Cable capacity	48 nF/km (at 1 kHz)
Nominal voltage, cable	$\leq 100 \text{ V}$
Test voltage Core/Core	700 V (50 Hz, 1 min.)
Test voltage Core/Shield	700.00 V (50 Hz, 1 min.)
Minimum bending radius, fixed installation	4 x D
Minimum bending radius, flexible installation	8 x D
Smallest bending radius, fixed installation	26 mm
Smallest bending radius, movable installation	52 mm
Tensile strength	$\leq 100 \text{ N}$
Near end crosstalk attenuation (NEXT)	71.3 dB (with 1 MHz)
	62.3 dB (at 4 MHz)
	56.3 dB (at 10 MHz)
	53.2 dB (at 16 MHz)
	51.8 dB (at 20 MHz)
	48.9 dB (at 31.25 MHz)
	44.4 dB (at 62.5 MHz)
	41.3 dB (at 100 MHz)
Power-summated near end crosstalk attenuation (PSNEXT)	62.3 dB (with 1 MHz)
	53.3 dB (at 4 MHz)
	47.3 dB (at 10 MHz)
	44.2 dB (at 16 MHz)
	42.8 dB (at 20 MHz)
	39.9 dB (at 31.25 MHz)
	35.4 dB (at 62.5 MHz)
	32.3 dB (at 100 MHz)
Return attenuation (RL)	23 dB (at 4 MHz)
	24.1 dB (at 8 MHz)
	25 dB (at 10 MHz)
	25 dB (at 16 MHz)
	25 dB (at 20 MHz)
	23.6 dB (at 31.25 MHz)
	21.5 dB (at 62.5 MHz)

NBC-FS/10,0-94B/R4MC SCO - Network cable



1407454

<https://www.phoenixcontact.com/us/products/1407454>

Shield attenuation	20.1 dB (at 100 MHz)
	3.2 dB (with 1 MHz)
	6 dB (at 4 MHz)
	9.5 dB (at 10 MHz)
	12.1 dB (at 16 MHz)
	13.6 dB (at 20 MHz)
	17.1 dB (at 31.25 MHz)
	24.8 dB (at 62.5 MHz)
	32 dB (at 100 MHz)
Halogen-free	according to IEC 60754-1
Flame resistance	according to IEC 60332-1-2
Resistance to oil	in accordance with EN 60811-2-1
Ambient temperature (operation)	-40 °C ... 80 °C (cable, fixed installation)
	-20 °C ... 80 °C (Cable, flexible installation)
Ambient temperature (installation)	-20 °C ... 80 °C

Environmental and real-life conditions

Ambient conditions

Degree of protection	IP65 (M12 connector)
	IP67 (M12 connector)
	IP67 (RJ45 connector)
Ambient temperature (operation)	-25 °C ... 90 °C (M12 connector)
	-20 °C ... 70 °C (RJ45 connector)

Standards and regulations

M12

Standard designation	M12 connector
Standards/specifications	IEC 61076-2-101

NBC-FS/10,0-94B/R4MC SCO - Network cable



1407454

<https://www.phoenixcontact.com/us/products/1407454>

Drawings

Dimensional drawing

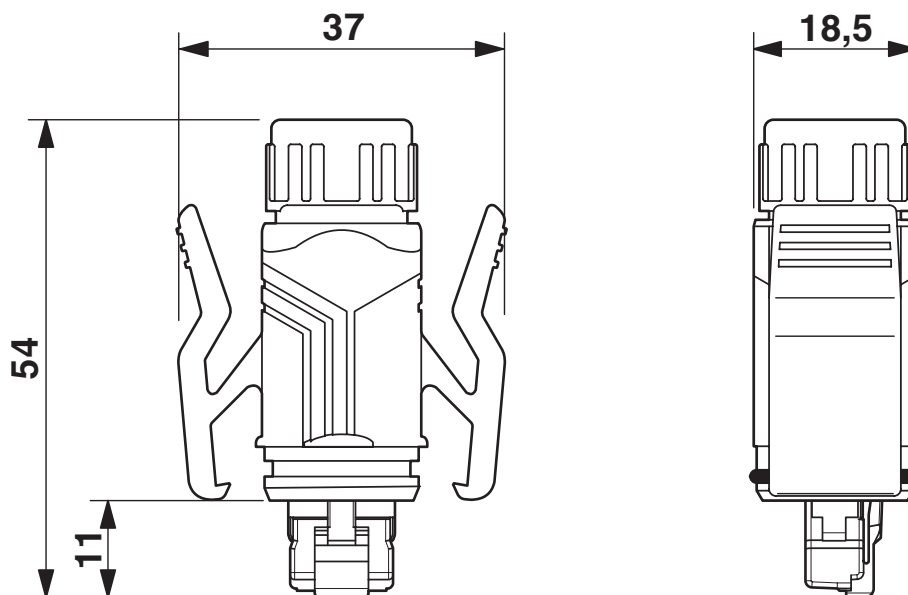

RJ45-connector, IP67

Schematic diagram

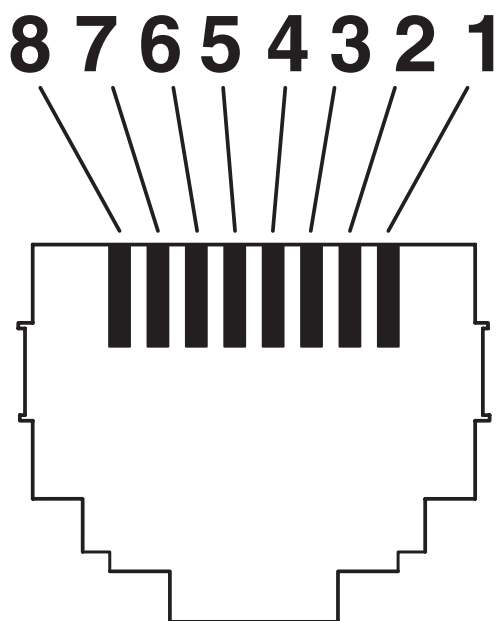

Connector pin assignment plug RJ45

1407454

<https://www.phoenixcontact.com/us/products/1407454>

Circuit diagram

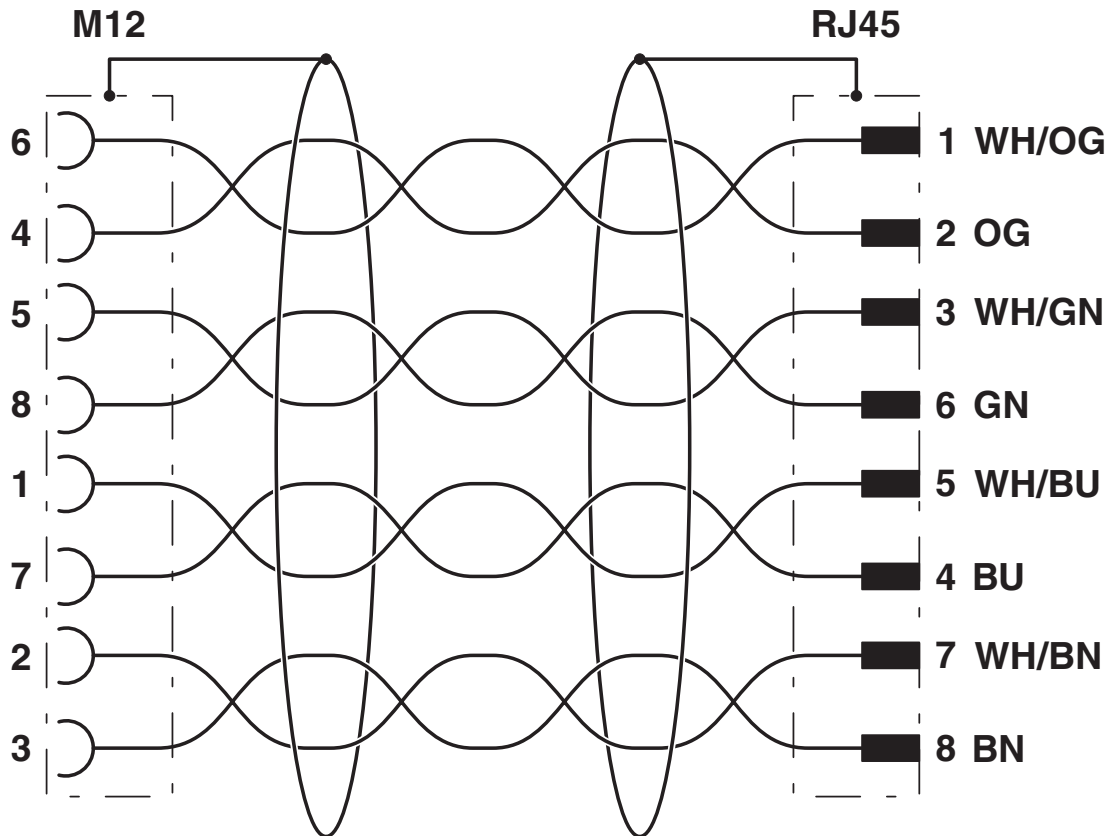

Dimensional drawing

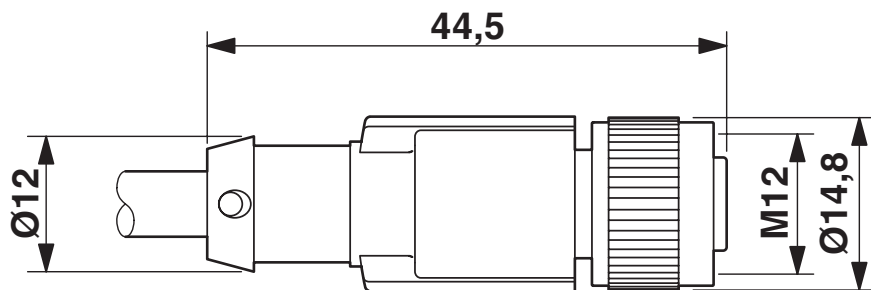

M12 x 1 socket, straight, shielded

1407454

<https://www.phoenixcontact.com/us/products/1407454>

Schematic diagram

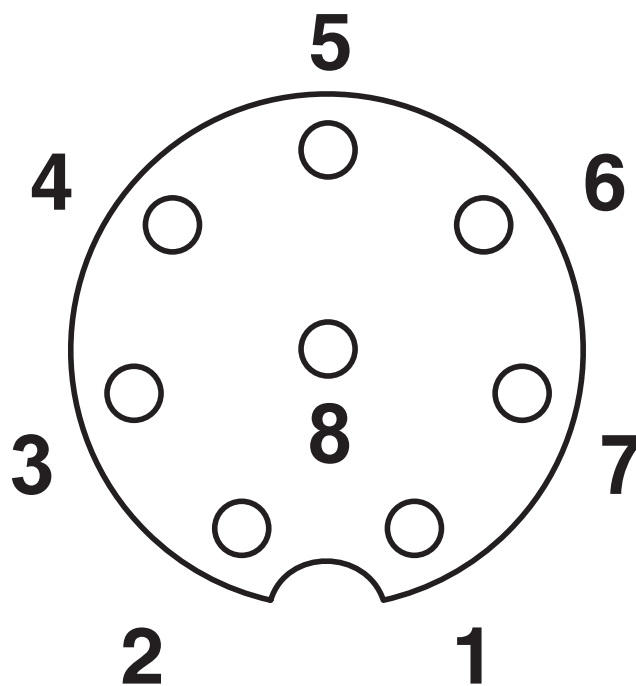

Pin assignment M12 socket, 8-pos., A-coded, view female side

NBC-FS/10,0-94B/R4MC SCO - Network cable



1407454

<https://www.phoenixcontact.com/us/products/1407454>

Classifications

ECLASS

ECLASS-11.0	27060307
ECLASS-12.0	27060307
ECLASS-13.0	27060307

ETIM

ETIM 9.0	EC001855
----------	----------

UNSPSC

UNSPSC 21.0	26121600
-------------	----------

NBC-FS/10,0-94B/R4MC SCO - Network cable



1407454

<https://www.phoenixcontact.com/us/products/1407454>

Environmental product compliance

EU RoHS

Fulfills EU RoHS substance requirements	Yes, No exemptions
---	--------------------

China RoHS

Environment friendly use period (EFUP)	EFUP-E
	No hazardous substances above the limits

EU REACH SVHC

REACH candidate substance (CAS No.)	6,6'-di-tert-butyl-2,2'-methylenedi-p-cresol(CAS: 119-47-1)
SCIP	cfe0a03b-3486-4bbb-bd43-6ac42bbee780

NBC-FS/10,0-94B/R4MC SCO - Network cable



1407454

<https://www.phoenixcontact.com/us/products/1407454>

Accessories

NBC-MS-R4MC SCO-IE/.../... - Network cable

1408679

<https://www.phoenixcontact.com/us/products/1408679>



Network cable, Ethernet CAT5 (1 Gbps), 8-position, shielded, Plug straight M12 SPEEDCON, coding: A / IP67, on Plug straight RJ45 Clip locking / IP20, cable length: Free input (0.2 ... 40.0 m)

NBC-MR-R4MC SCO-IE/.../... - Network cable

1408671

<https://www.phoenixcontact.com/us/products/1408671>



Network cable, Ethernet CAT5 (1 Gbps), 8-position, shielded, Plug angled M12 SPEEDCON, coding: A / IP67, on Plug straight RJ45 Clip locking / IP20, cable length: Free input (0.2 ... 40.0 m)

NBC-FS/10,0-94B/R4MC SCO - Network cable

1407454

<https://www.phoenixcontact.com/us/products/1407454>



NBC-FS-R4MC SCO-IE/.../... - Network cable

1408662

<https://www.phoenixcontact.com/us/products/1408662>



Network cable, Ethernet CAT5 (1 Gbps), 8-position, shielded, Socket straight M12 SPEEDCON, coding: A / IP67, on Plug straight RJ45 Clip locking / IP20, cable length: Free input (0.2 ... 40.0 m)

NBC-FR-R4MC SCO-IE/.../... - Network cable

1408653

<https://www.phoenixcontact.com/us/products/1408653>

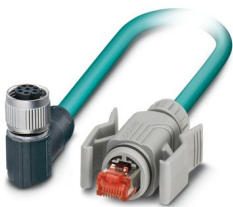

Network cable, Ethernet CAT5 (1 Gbps), 8-position, shielded, Socket angled M12 SPEEDCON, coding: A / IP67, on Plug straight RJ45 Clip locking / IP20, cable length: Free input (0.2 ... 40.0 m)

NBC-FS/10,0-94B/R4MC SCO - Network cable

1407454

<https://www.phoenixcontact.com/us/products/1407454>



PROT-M12 MS-PA-CHAIN - Screw plug

1430899

<https://www.phoenixcontact.com/us/products/1430899>

M12 sealing cap with fixing band, for sensor cables, for free M12 sockets



SAC-M12-EXCLIP-F - Locking clip

1558991

<https://www.phoenixcontact.com/us/products/1558991>

Locking clip for the socket side of sensor/actuator cables with M12 connector and M12 connectors for assembly, for knurl diameter: 15 mm or for Allen key with a wrench size of 14 mm, prevents the disconnection of plug-in connections without tools



NBC-FS/10,0-94B/R4MC SCO - Network cable



1407454

<https://www.phoenixcontact.com/us/products/1407454>

TSD 04 SAC - Torque screwdriver

1208429

<https://www.phoenixcontact.com/us/products/1208429>



Torque screwdriver, with preset torque of 0.4 Nm and 4 mm hexagonal drive for M12 connectors

TSD-M 1,2NM - Torque screwdriver

1212224

<https://www.phoenixcontact.com/us/products/1212224>



Torque screw driver, accuracy as per EN ISO 6789 standard, adjustable from 0.3 - 1.2 Nm

NBC-FS/10,0-94B/R4MC SCO - Network cable



1407454

<https://www.phoenixcontact.com/us/products/1407454>

TSD-M SAC-BIT ADAPTER - Adapter insert

1212600

<https://www.phoenixcontact.com/us/products/1212600>



Adapter bit for TSD-M...torque tools, E6.3-1/4" drive with 4 mm hexagon to accommodate SAC bits

SAC BIT M12-D15 - Tool

1208432

<https://www.phoenixcontact.com/us/products/1208432>



Nut for assembling sensor/actuator cables with M12 connector and M12 connectors for assembly, with a knurl diameter of 15 mm, for 4 mm hexagonal drive

Phoenix Contact 2024 © - all rights reserved
<https://www.phoenixcontact.com>

Phoenix Contact USA
586 Fulling Mill Road
Middletown, PA 17057, United States
(+717) 944-1300
info@phoenixcon.com