

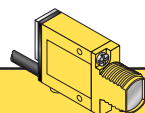

- Compact, modulated, self-contained convergent mode sensors for 24-240V ac operation
- Produces a precise 1.3 mm (0.05 in) diameter sensing spot at a focus point 16 mm (0.65 in) from the lens surface (model SM2A312CV) or a 3.0 mm (0.12 in) sensing spot at 43 mm (1.70 in) focus (model SM2A312CV2)
- Switch-selectable for light operate or dark operate
- SPST SCR solid-state output switches up to 300mA; low leakage current and saturation voltage
- Rugged, epoxy-encapsulated construction: meets NEMA standards 1, 2, 3, 3S, 4, 4X, 12 and 13; IEC IP67
- Physically and electrically interchangeable with 18 mm barrel-type photoelectrics



Visible red, 650 nm



**MINI-BEAM Convergent Mode**

Models	Range	Cable	Supply Voltage	Output Type	Excess Gain	Beam Pattern
					Performance based on 90% reflectance white test card	
SM2A312CV SM2A312CVQD	16 mm (0.65 in)  Spot Size at Focus: 1.3 mm (0.05 in)	2 m (6.5 ft) 3-Pin Micro QD	24-240V ac	SPST Solid-state 2-Wire		
SM2A312CV2 SM2A312CV2QD	43 mm (1.7 in)  Spot Size at Focus: 3.0 mm (0.12 in)	2 m (6.5 ft) 3-Pin Micro QD	24-240V ac	SPST Solid-state 2-Wire		

**For Standard MINI-BEAMS:**

- 9 m (30 ft) cables are available by adding suffix "W/30" to the model number of any cabled sensor (e.g. - SM2A312CV W/30).
- A 150 mm (6 in.) long pigtail cable with attached QD connector is available by adding suffix "QDP" to the model number of any MINI-BEAM sensor (e.g. - SM2A312CVQDP). See page 5 for more information.
- A model with a QD connector requires an accessory mating cable. See page 5 for more information.

## MINI-BEAM Installation and Alignment

Proper operation of the SM2A312CV or SM2A312CV2 sensor requires that it be mounted securely and aligned properly. In some applications, excessive movement or vibration can result in intermittent or false operation caused by loss of alignment. For best results, final-mount the sensor in an 18mm-hole by its threaded barrel or use a mounting bracket (see page 6).

Begin with the sensor at the approximate position where it will be mounted. With power applied to the circuit and with the sensor set for "light operate", direct the sensor's visible red spot at the object approximately 16 mm (0.65 in) (for model SM2A312CV) or 43 mm (1.7 in) (for model SM2A312CV2) directly in front of the lens. Move the sensor very slightly toward or away from the object while observing the red LED indicator on the back of the sensor. Note the near and far points at which sensing occurs (the range of distance over which the LED remains lit). Mount the sensor at a point approximately midway in the range. This should correspond to the point at which the red sensing spot on the object appears most sharply defined. Mount the sensor at this position and distance.

### CONVERGENT MODE ALIGNMENT

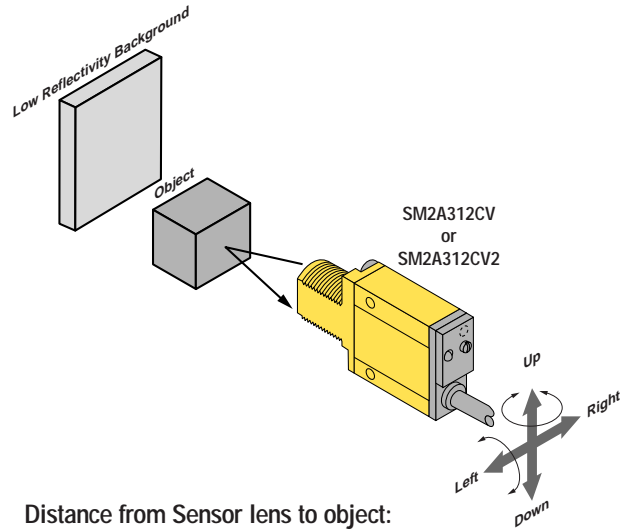

Distance from Sensor lens to object:  
16 mm (0.65 in) for SM2A312CV  
43 mm (1.7 in) for SM2A312CV2

### SM2A312CV OR CV2

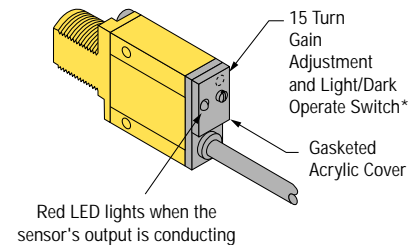

**\* Note regarding Light/Dark operate switch:**

- Turn switch *fully* clockwise for light operate (sensor outputs conduct when object is present)
- Turn switch *fully* counterclockwise for dark operate (sensor outputs conduct when object is absent)

# MINI-BEAM<sup>®</sup> Sensors SM2A312CV and SM2A312CV2

MINI-BEAM AC Product Specifications	
Supply Voltage and Current	24 to 240V ac (50/60 Hz), 250V ac max
Supply Protection Circuitry	Protected against transient voltages
Output Configuration	SPST SCR solid-state relay with either normally closed or normally open contact (light/dark operate selectable); 2-wire hookup
Output Rating	Minimum load current 5 mA; maximum steady-state load capability 300 mA to 50°C ambient (122°F) 100 mA to 70°C ambient (158°F) <b>Inrush capability</b> 3 amps for 1 second (non-repetitive); 10 amps for 1 cycle (non-repetitive) <b>Off-state leakage current</b> less than 1.7 mA rms <b>On-state voltage</b> drop ≤5 volts at 300 mA load, ≤10 volts at 15 mA load
Output Protection Circuitry	Protected against false pulse on power-up
Output Response Time	4 milliseconds on and off "OFF" response time specification does not include load response of up to 1/2 ac cycle (8.3 milliseconds). Response time specification of load should be considered when important. (NOTE: 300 millisecond delay on power-up.)
Repeatability	1.3 milliseconds; Response time and repeatability specifications are independent of signal strength.
Adjustments	LIGHT/DARK OPERATE select switch, and 15-turn slotted brass screw GAIN (sensitivity) adjustment potentiometer (clutched at both ends of travel). Both controls are located on rear panel of sensor and protected by a gasketed, clear acrylic cover.
Indicators	Red indicator LED on rear of sensor is "ON" when the load is energized
Construction	Reinforced VALOX <sup>®</sup> housing, totally encapsulated, o-ring sealing, acrylic lenses, and stainless steel screws
Environmental Rating	Meets NEMA standards 1, 2, 3, 3S, 4, 4X, 12, and 13; IEC IP67
Connections	PVC-jacketed 2-conductor 2 m (6.5ft) or 9 m (30ft) cables, or 3-pin micro-style quick disconnect (QD) fitting are available. QD cables are ordered separately. See page 5.
Operating Temperature	<b>Temperature:</b> -20° to +70°C (-4° to +158°F) <b>Maximum Relative Humidity:</b> 90% at 50°C (non-condensing)
Application Notes	i) ac MINI-BEAMs may be destroyed from overload conditions ii) Use on low voltage requires careful analysis of the load to determine if the leakage current or on-state voltage of the sensor will interfere with proper operation of the load iii) The false-pulse protection feature may cause momentary drop-out of the load when the sensor is wired in series or parallel with mechanical switch contacts
Certifications	

VALOX<sup>®</sup> is a registered trademark of General Electric Company

## MINI-BEAM AC Hookup Diagrams

### AC Sensors with Attached Cable

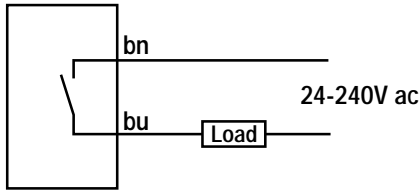

### AC Sensors with Quick Disconnect (3-Pin Micro-Style)

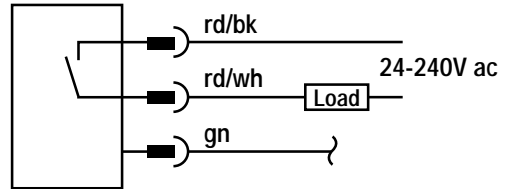

### 3-Pin Micro-Style Pin-out (Cable Connector Shown)

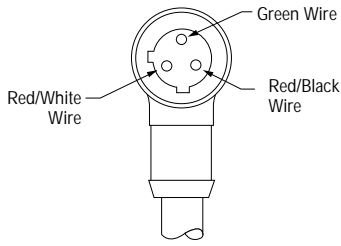

### Quick Disconnect (QD) Option

AC MINI-BEAM sensors are sold with either a 2 m (6.5 ft) or a 9 m (30 ft) attached PVC-covered cable, or with a 3-pin micro-style QD cable fitting.

AC QD sensors are identified by the letters "QD" in their model number suffix. For more information on mating QD cables, see page 5.

## MINI-BEAM Dimension Information

### MINI-BEAM AC Sensor with Integral Cable

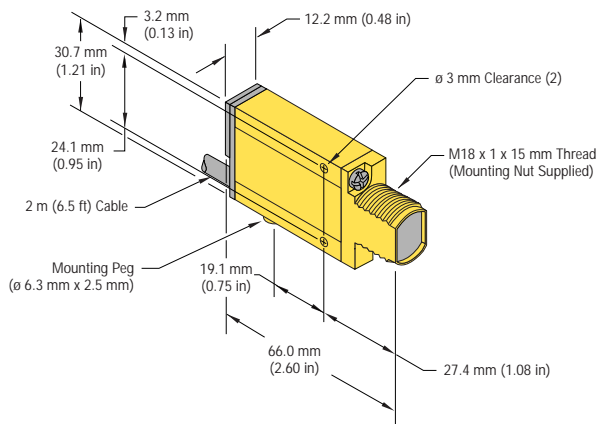

### MINI-BEAM AC Sensor with Quick-Disconnect

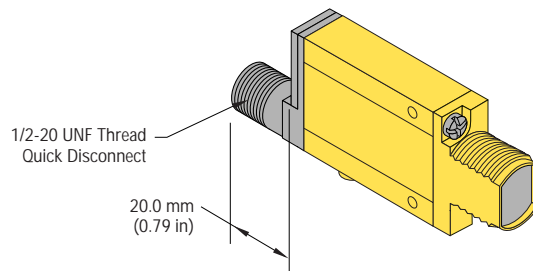

# MINI-BEAM<sup>®</sup> Sensors SM2A312CV and SM2A312CV2

MINI-BEAM MODIFICATIONS			
Model Suffix	Modification	Description	Example of Model Number
W/30	9 meter (30 ft) cable	All MINI-BEAM sensors may be ordered with an integral 9 m (30 ft) cable in place of the standard 2 m (6.5 ft) cable	SM2A312CV W/30
QDP	Pigtail Quick Disconnect	All MINI-BEAMS may be built with a 150 mm (6 in) long integral cable which is terminated with the appropriate QD connector.	SM2A312CVQDP



Replacement Lens Assemblies		
MINI-BEAM lens assemblies are field-replaceable.		
Model	Description	
UC-300C.7	Replacement lens for CV	
UC-300C2	Replacement lens for CV2	

Micro-Style Quick Disconnect Cables				
<p><b>Cable:</b> PVC jacket, polyurethane connector body, nickel-plated brass coupling nut  <b>Conductors:</b> 22 or 20 AWG high-flex stranded, PVC insulation, gold-plated contacts  <b>Temperature:</b> -40 to +80°C (-40 to +176°F)  <b>Voltage Rating:</b> 250V ac/300V dc (3-pin), 125V ac/150V dc (4-pin)</p>				
Style	Model	Length	Dimensions	Pin-out
3-Pin Straight	MQDC-306	2 m (6.5 ft)		
	MQDC-315	5 m (15 ft)		
MQDC-330	9 m (30 ft)			
3-Pin Right-angle	MQDC-306RA	2 m (6.5 ft)		
	MQDC-315RA	5 m (15 ft)		
	MQDC-330RA	9 m (30 ft)		

# MINI-BEAM® Sensors SM2A312CV and SM2A312CV2

## Extension Cables (without connectors)

The following cables are available for extending the length of existing sensor cable. These are 30 m (100 ft) lengths of MINI-BEAM cable. This cable may be spliced to existing cable. Connectors, if used, must be customer-supplied.

Model	Type	Used with:
EC312A-100	2-conductor	All MINI-BEAM SM2A312 ac models

## Mounting Brackets

Model	Description		
SMB312S	Stainless steel 2-axis, side mounting bracket		
SMB312PD	Stainless steel 18 mm barrel-mounting bracket		
SMB312B	Stainless steel 2-axis, bottom mounting bracket Includes SMB12F (below)		
SMB46L	<ul style="list-style-type: none"> <li>• "L" bracket</li> <li>• 14 ga 316 stainless steel</li> </ul>		

Mounting Brackets			
Model	Description	Dimensions	
SMB46S	<ul style="list-style-type: none"> <li>• “S” bracket</li> <li>• 14 ga 316 stainless steel</li> </ul>	<p>Technical drawing of the SMB46S bracket. Dimensions include: 34 mm (1.3 in) total width, 10 mm (0.4 in) top flange, 17 mm (0.7 in) sensor mounting distance, 3.5 mm (0.14 in) top thickness, 6 mm (0.2 in) side flange, 15 mm (0.6 in) sensor mounting distance, 6 mm (0.2 in) side flange, 8 mm (0.3 in) hole offset, 5 mm (0.2 in) hole offset (4x), 16 mm (0.6 in) bottom flange, 65 mm (2.6 in) total height, 2 mm (0.1 in) bottom thickness, 27 mm (1.1 in) bottom flange, and 16 mm (0.6 in) sensor mounting distance. Hole diameters are <math>\phi 3.6</math> mm (1.4 in) and <math>\phi 6.5</math> mm (0.26 in) (6x).</p>	
SMB46U	<ul style="list-style-type: none"> <li>• “U” bracket</li> <li>• 14 ga 316 stainless steel</li> </ul>	<p>Technical drawing of the SMB46U bracket. Dimensions include: 34 mm (1.3 in) total width, 17 mm (0.7 in) top flange, 13 mm (0.5 in) top flange, 6 mm (0.2 in) side flange, 15 mm (0.6 in) sensor mounting distance, 6 mm (0.2 in) side flange, 8 mm (0.3 in) hole offset, 5 mm (0.2 in) hole offset (4x), 16 mm (0.6 in) bottom flange, 65 mm (2.6 in) total height, 2 mm (0.1 in) bottom thickness, 27 mm (1.1 in) bottom flange, 70 mm (2.8 in) bottom flange, and 16 mm (0.6 in) sensor mounting distance. Hole diameters are <math>\phi 3.6</math> mm (1.4 in) and <math>\phi 6.5</math> mm (0.26 in) (6x).</p>	
SMB18C	<ul style="list-style-type: none"> <li>• 18 mm split clamp black VALOX® bracket</li> <li>• Stainless steel mounting hardware included</li> </ul>	<p>Technical drawing of the SMB18C bracket. Dimensions include: 40.0 mm (1.60 in) total width, 42.4 mm (1.67 in) total height, 14.0 mm (0.55 in) bottom flange, 30.0 mm (1.18 in) bottom flange, 21.1 mm (0.83 in) sensor mounting distance, 2.5 mm (0.10 in) bottom thickness, and 13 mm (0.5 in) sensor mounting distance. Hardware includes a Nut Plate and M5 x 0.8 x 60 mm Screw (2).</p>	
SMB18S	<ul style="list-style-type: none"> <li>• 18 mm swivel, black VALOX® bracket</li> <li>• Stainless steel mounting hardware included</li> </ul>	<p>Technical drawing of the SMB18S bracket. Dimensions include: 46.0 mm (1.81 in) total width, 44.5 mm (1.75 in) total height, 13.0 mm (0.50 in) bottom flange, 36.0 mm (1.42 in) bottom flange, 25.4 mm (1.00 in) sensor mounting distance, 2.5 mm (0.10 in) bottom thickness, 10.9 mm (0.43 in) sensor mounting distance, and 6.4 mm (0.25 in) sensor mounting distance. Hardware includes a Spacer (If Required), Nut Plate, and M5 x 0.8 x 60 mm Screw (2).</p>	

# MINI-BEAM® Sensors SM2A312CV and SM2A312CV2

---



**WARRANTY:** Banner Engineering Corporation warrants its products to be free from defects for one year. Banner Engineering Corporation will repair or replace, free of charge, any product of its manufacture found to be defective at the time it is returned to the factory during the warranty period. This warranty does not cover damage or liability for the improper application of Banner products. This warranty is in lieu of any other warranty either expressed or implied.



**WARNING** These photoelectric presence sensors do NOT include the self-checking redundant circuitry necessary to allow their use in personnel safety applications. A sensor failure or malfunction can result in either an energized or a de-energized sensor output condition.

Never use these products as sensing devices for personnel protection. Their use as a safety device may create an unsafe condition which could lead to serious injury or death.

Only MINI-SCREEN®, MULTI-SCREEN®, MICRO-SCREEN™, MACHINE-GUARD™ and PERIMETER-GUARD™ Systems, and other systems so designated, are designed to meet OSHA and ANSI machine safety standards for point-of-operation guarding devices. No other Banner sensors or controls are designed to meet these standards, and they must NOT be used as sensing devices for personnel protection.