

116C-216C and 117C-217C series

POWERSTAT Variable Transformers of the 116C and 117C Series operate from 120 volt lines and 216C and 217C Series operate from 240 volt lines. All models feature POWERKOTE coils. The rated output for constant current loads is 10 amperes for the 116C Series; 12 amperes for the 117C Series; 3.5 amperes for the 216C Series; and 5 amperes for the 217C Series. For a constant impedance load the maximum rated output current at line voltage is increased to 13 amperes for the 116C Series; 15 amperes for the 117C Series; 5 amperes for the 216C Series and 7 amperes for the 217C Series. Single, manually operated units have both 3-hole and 4-hole mounting arrangements; all others have the 4-hole mounting.

As shown in Figure A, assemblies of the 116C-216C Series can be operated at 50 to 1500 hertz and those of the 117C-217C Series can be operated at any frequency between 60 and 1500 hertz without reduction in allowable output current. Except for 216C types and the 217C types operating at the constant current rating, there is a slight reduction between 1500 and 2000 hertz. Figure B shows the regulation curves for types of the 116C-216C and 117C-217C Series operating at full load current. The curves show the voltage drop at any brush setting when full load is applied. For less than full load the voltage drop is proportional to the load.

Single units of the 117C-217C Series and cord-and-plug models of the 116C-216C Series have dials graduated in volts. Other single units of the 116C-216C Series and all ganged units have dials graduated 0-100. The angle of rotation from zero to maximum voltage is 317.5°.

Open construction models have a letter U suffix in the type number and have the shaft extending from the base end of the assembly for panel mounting. Knobs can also be placed at the radiator end of the assemblies for general utility mounting because the shafts are removable.

TYPE†	Approximate Driving Torque		No-Load Loss at 60 Hertz (Watts)	D-C Resistance per Coil* (Ohms)
	Oz-In	KpCm		
116CU	20-30	1.4-2.2	6.5	1.1
116C-2	60-75	4.3-5.4	13	1.1
116C-3	100-125	7.2-9	19.5	1.1
117CU	20-30	1.4-2.2	8.5	0.49
117C-2	60-75	4.3-5.4	17	0.49
117C-3	100-125	7.2-9	25.5	0.49
216CU	20-30	1.4-2.2	6.5	10.8
216C-2	60-75	4.3-5.4	13	10.8
216C-3	100-125	7.2-9	19.5	10.8
217C	20-30	1.4-2.2	8.5	3.9
217C-2	60-75	4.3-5.4	17	3.9
217C-3	100-125	7.2-9	25.5	3.9

*Measured from start to end of winding.

†Data also applies to units having applicable prefixes and suffixes.

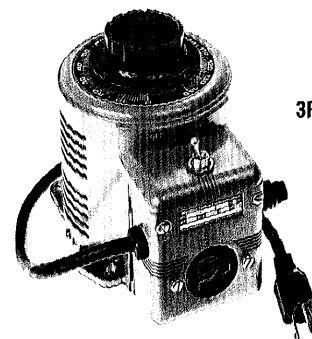

3PN TYPES

All plug-in models have input cord-plug sets, output receptacles, switches and fuses and are connected for clockwise knob rotation. Plug-receptacle constructions available are shown in the outline for plug-in types on page 13. Units of the 116C-216C Series are connected for overvoltage operation with provision for changing in the field to limit the output voltage to line voltage. Units in the 117C-217C Series have output voltage limited to line voltage. All models can be changed in the field to provide increasing output voltage with counterclockwise knob rotation.

Motor-driven POWERSTAT Variable Transformers have a letter M prefix in the type number. When ordering, the type number should be prefixed with the desired speed in seconds. For example: 5M116CT.

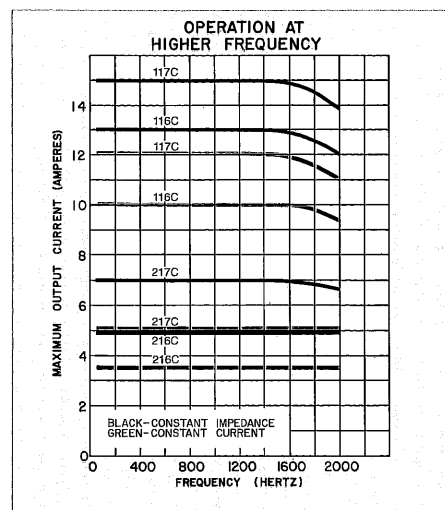

FIGURE A

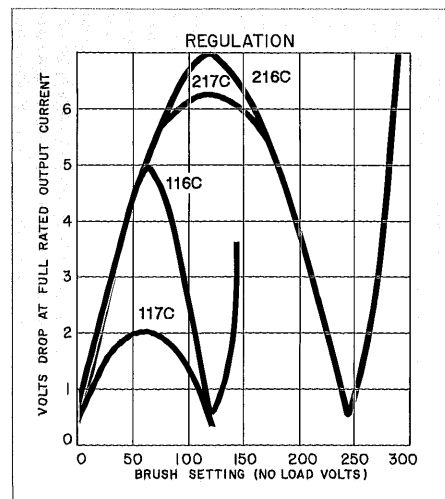
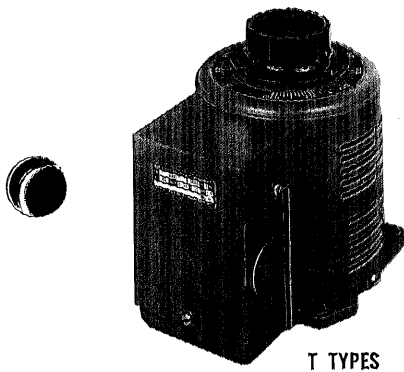
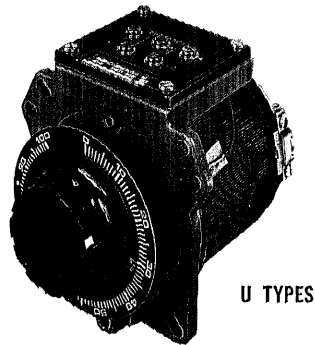

FIGURE B



T TYPES



U TYPES

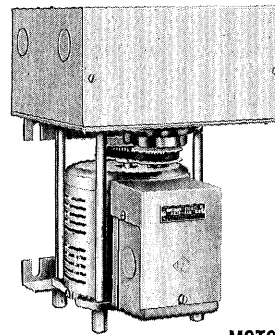

MOTOR-DRIVEN TYPES

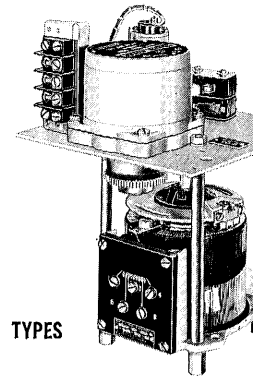

CONNECTIONS AND RATINGS

TYPE	CONNECTION	INPUT		OUTPUT				KNOB ROTATION	TERMINALS						
		VOLTS	HERTZ	VOLTS	CONSTANT CURRENT LOAD		CONSTANT IMPEDANCE LOAD		KNOB ON RADIATOR END		KNOB ON BASE END				
					MAX. AMP.	MAX. KVA	MAX. AMP.		MAX. KVA	INPUT	OUTPUT	INPUT	OUTPUT		
116C 3PN116C	#1	120	50/60	0-120	10	1.2	13	1.6	CW	1-4	1-3	1-4	3-4		
				0-140	10	1.4	—	—	CCW	1-4	3-4	1-4	1-3		
116CT M116CT § 116CU M116CU §	#2	120	50/60	0-120	10	1.2	13	1.6	CW	1-4	1-3	1-4	3-4		
				0-140	10	1.4	—	—	CCW	1-4	3-4	1-4	1-3		
3PN117C	#1	120	60	0-120	12	1.4	15	1.8	CW	1-4 †	1-3	1-4	3-4		
117CT M117CT § 117CU M117CU §	#2	120	60	0-120	12	1.4	15	1.8	CW	1-4	1-3	1-4	3-4		
216C 3PN216C	#1	240	50/60	0-240	3.5	0.84	5	1.2	CW	1-4	1-3	1-4	3-4		
		120	50/60	0-280	3.5	0.98	—	—	CW	1-2 †	1-3	4-5	3-4		
216CT M216CT § 216CU M216CU §	#2	240	50/60	0-240	3.5	0.84	5	1.2	CW	1-4	1-3	1-4	3-4		
		120	50/60	0-280	3.5	0.98	—	—	CW	1-2	1-3	4-5	3-4		
3PN217C	#1	240	60	0-240	5	1.2	7	1.7	CW	1-4 †	1-3	1-4	3-4		
217CT M217CT § 217CU M217CU §	#2	240	60	0-240	5	1.2	7	1.7	CW	1-4	1-3	1-4	3-4		

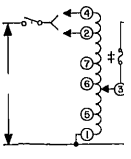

CONNECTION 1

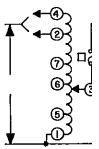

CONNECTION 2

116C TYPES DO NOT HAVE TERMINALS 6 OR 7

117C-217C TYPE DO NOT HAVE TERMINALS 2, 5, 6 OR 7

CONNECTIONS SHOWN ARE FOR CW KNOB ROTATION. KNOB ON RADIATOR END (CCW ROT/ KNOB ON BASE

*Maximum output current in output voltage range up to 150 volts. At higher output voltages output current must be reduced according to rating curve Figure B on page 4.

†Maximum KVA at maximum output voltage. Maximum KVA at lower output voltages may be calculated from rating curve Figure B on page 4.

‡Fuse supplied: 10 ampere on 116C types, 15 ampere on 117C types, 4 ampere on 216C types, 8 ampere on 217C types.

§Motor-driven types use connections for CW rotation, knob on radiator end.

¶Unit wired this way when shipped.

⊞Fuse recommended, not supplied.

CONNECTIONS AND RATINGS

TYPE	CONNECTION	INPUT		OUTPUT				KNOB ROTATION	TERMINALS								
		VOLTS	HERTZ	VOLTS	CONSTANT CURRENT LOAD		CONSTANT IMPEDANCE LOAD		KNOB ON RADIATOR END			KNOB ON BASE END					
					MAX. AMP.	MAX. KVA	MAX. AMP.		MAX. KVA	INPUT	JUMPERS	OUTPUT	INPUT	JUMPERS	OUTPUT		
116CU-2 M116CU-2 ◻	#1 1-Phase Series	240	50/60	0-240	10	2.4	13	3.1	CW	4-4	1-1	3-3	1-1	4-4	3-3		
				0-280	10	2.8	—	—	CCW	1-1	4-4	3-3	4-4	1-1	3-3		
		120	50/60	0-120	10	2.1	13	2.7	CW	2-2	1-1	3-3	5-5	4-4	3-3		
				0-140	10	2.4	—	—	CCW	5-5	4-4	3-3	2-2	1-1	3-3		
	#1 3-Phase Open Delta	120	50/60	0-120	10	2.1	13	2.7	CW	4-1-4	1-1	3-1-3	1-4-1	4-4	3-4-3		
				0-140	10	2.4	—	—	CCW	1-4-1	4-4	3-4-3	4-1-4	1-1	3-1-3		
117CU-2 M117CU-2 ◻	#1 1-Phase Series	240	60	0-240	12	2.9	15	3.6	CW	4-4	1-1	3-3	1-1	4-4	3-3		
				0-280	12	3.3	—	—	CCW	1-1	4-4	3-3	4-4	1-1	3-3		
	#1 3-Phase Open Delta	120	60	0-120	12	2.5	15	3.1	CW	4-1-4	1-1	3-1-3	1-4-1	4-4	3-4-3		
				0-140	12	2.8	—	—	CCW	1-4-1	4-4	3-4-3	4-1-4	1-1	3-1-3		
216CU-2 M216CU-2 ◻	#1 1-Phase Series	480	50/60	0-480	3.5	1.7	5	2.4	CW	4-4	1-1	3-3	1-1	4-4	3-3		
				0-560	3.5	2.0	—	—	CCW	1-1	4-4	3-3	4-4	1-1	3-3		
		240	50/60	0-560	3.5*	0.85‡	—	—	CW	6-6	1-1	3-3	7-7	4-4	3-3		
				0-280	3.5	1.5	5	2.1	CCW	7-7	4-4	3-3	6-6	1-1	3-3		
	#1 3-Phase Open Delta	240	50/60	0-240	3.5	1.5	5	2.1	CW	4-1-4	1-1	3-1-3	1-4-1	4-4	3-4-3		
				0-280	3.5	1.7	—	—	CCW	1-4-1	4-4	3-4-3	4-1-4	1-1	3-1-3		
		120	50/60	0-280	3.5*	0.74‡	—	—	CW	6-1-6	1-1	3-1-3	7-4-7	4-4	3-4-3		
				0-280	3.5*	0.74‡	—	—	CCW	7-4-7	4-4	3-4-3	6-1-6	1-1	3-1-3		
		217CU-2 M217CU-2 ◻	#1 1-Phase Series	480	60	0-480	5	2.4	7	3.4	CW	4-4	1-1	3-3	1-1	4-4	3-3
						0-280	5	2.1	7	2.9	CCW	1-1	4-4	3-3	4-4	1-1	3-3
#1 3-Phase Open Delta	240		60	0-240	5	2.1	7	2.9	CW	4-1-4	1-1	3-1-3	1-4-1	4-4	3-4-3		
				0-280	5	2.4	—	—	CCW	1-4-1	4-4	3-4-3	4-1-4	1-1	3-1-3		
116CU-3 M116CU-3 ◻	#2 3-Phase Wye	240	50/60	0-240	10	4.2	13	5.4	CW	4-4-4	1-1-1	3-3-3	1-1-1	4-4-4	3-3-3		
				0-280	10	4.8	—	—	CCW	1-1-1	4-4-4	3-3-3	4-4-4	1-1-1	3-3-3		
		60	0-280	0-240	12	5.0	15	6.2	CW	2-2-2	1-1-1	3-3-3	5-5-5	4-4-4	3-3-3		
				0-280	10	4.8	—	—	CCW	5-5-5	4-4-4	3-3-3	2-2-2	1-1-1	3-3-3		
117CU-3 M117CU-3 ◻	#2 3-Phase Wye ¶	240	60	0-240	12	5.0	15	6.2	CW	4-4-4	1-1-1	3-3-3	1-1-1	4-4-4	3-3-3		
				0-280	10	4.8	—	—	CCW	1-1-1	4-4-4	3-3-3	4-4-4	1-1-1	3-3-3		
216CU-3 M216CU-3 ◻	#2 3-Phase Wye	480	50/60	0-480	3.5	2.9	5	4.2	CW	4-4-4	1-1-1	3-3-3	1-1-1	4-4-4	3-3-3		
				0-560	3.5	3.4	—	—	CCW	1-1-1	4-4-4	3-3-3	4-4-4	1-1-1	3-3-3		
	60	0-560	0-480	3.5	2.9	5	4.2	CW	2-2-2	1-1-1	3-3-3	5-5-5	4-4-4	3-3-3			
			0-560	3.5*	1.5‡	—	—	CCW	5-5-5	4-4-4	3-3-3	2-2-2	1-1-1	3-3-3			
217CU-3 M217CU-3 ◻	#2 3-Phase Wye ¶	480	60	0-480	5	4.2	7	5.8	CW	4-4-4	1-1-1	3-3-3	1-1-1	4-4-4	3-3-3		
				0-280	5	3.9	—	—	CCW	1-1-1	4-4-4	3-3-3	4-4-4	1-1-1	3-3-3		

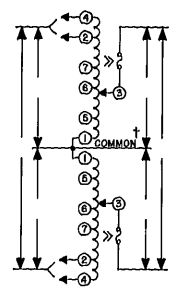

CONNECTION 1

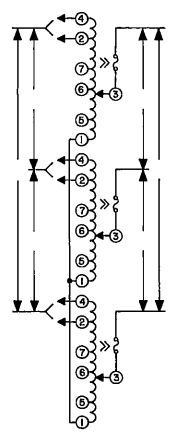

CONNECTION 2

116C TYPES
DO NOT HAVE
TERMINALS
6 OR 7

117C-217C TYPES
DO NOT HAVE
TERMINALS
2, 5, 6 OR 7

CONNECTIONS
SHOWN ARE FOR
CW KNOB
ROTATION.
KNOB ON RADIATOR
END (CCW ROTATION
KNOB ON BASE END)

*Maximum output current in output voltage range from 0 to 25 percent above line voltage. At higher output voltages output current must be reduced according to rating curve Figure B on page 4.

†Common used as third leg in 3-phase open delta on neutral in 3-wire single phase series and 4-wire 3-phase wye connections; not used in 2-wire series or 3-wire wye connections.

‡Maximum KVA at maximum output voltage. Maximum KVA at lower output voltages may be calculated from rating curve Figure B on page 4.

§Jumper provided in standard common position should be moved or removed as required.

¶Three-wire system only. There must be no neutral connection in input or output.

◻ Motor-driven types use connections for CW rotation, knob on radiator end.

116C-216C and 117C-217C series

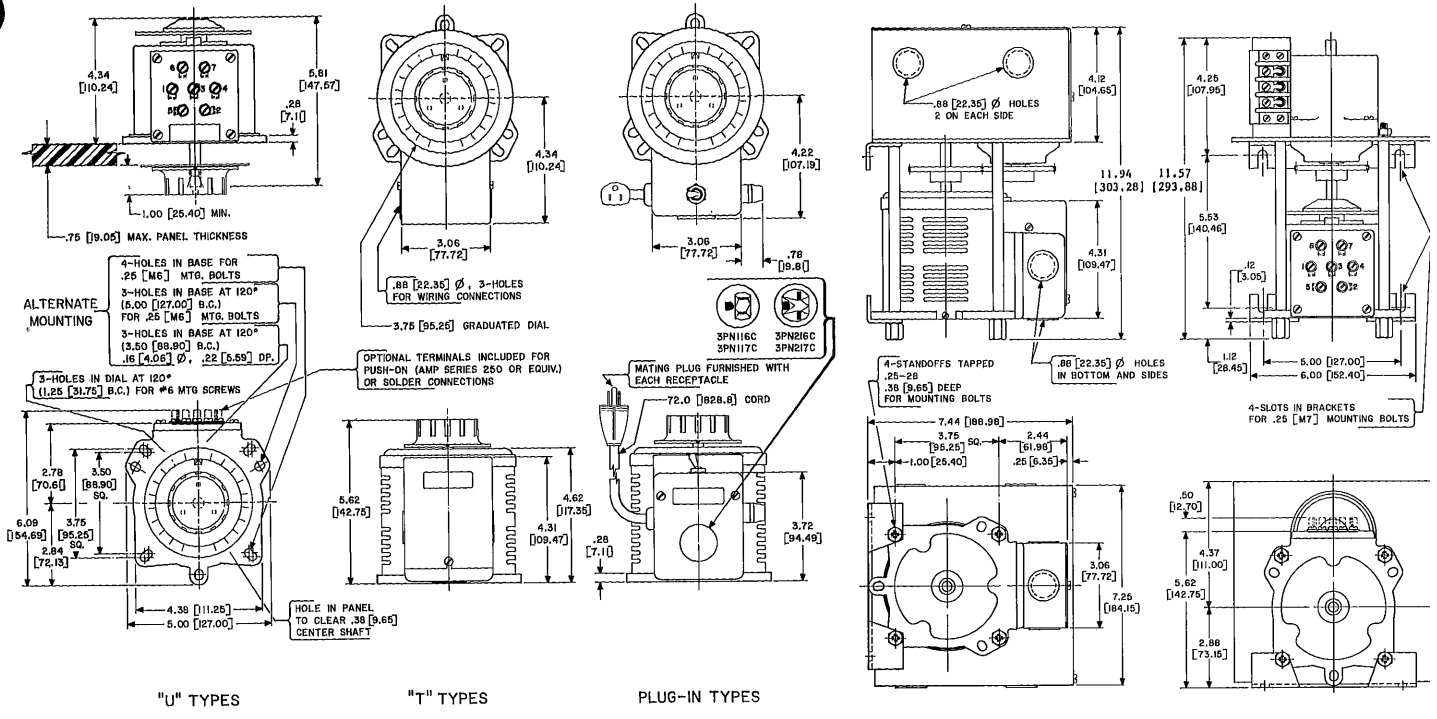

TYPE	"A"	"B"	"C"	"D"	"E"	"F"
2-GANG	10.00 [254.00]	4.44 [112.76]	11.31 [287.27]	16.75 [425.45]	16.47 [418.34]	10.44 [265.18]
3-GANG	14.88 [377.95]	9.34 [237.24]	16.22 [411.99]	21.65 [549.91]	21.38 [543.05]	15.34 [389.64]

