



MM and MQ Magnetic Proximity Sensors

Shorter body – higher operating distance

Magnetic proximity sensors

Operating principle

Permanent magnets are usually used to trigger magnetic proximity sensors. They comprise magnetically hard substances – steel alloyed with other metals such as aluminium, cobalt and nickel. Magnetically hard ferrite with similar properties can also be produced from sintered compounds containing iron oxide and other metal oxides.

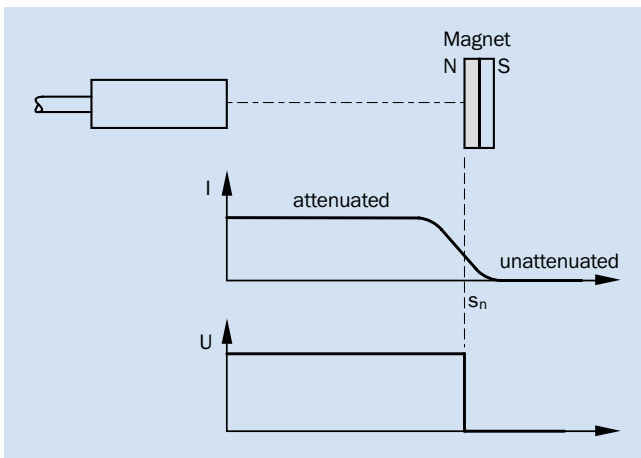

Glossary

Response sensitivity

The response sensitivity applies to both magnetic field poles without external field interference. In rooms and industrial plants, external magnetic fields are caused by the earth's magnetic field, electrical conductors, magnetic coils, permanent magnets, and steel objects containing residual magnetism. Neighbouring iron parts may increase external interference or have a shielding effect. External magnetic fields are usually constant or periodically effective and can therefore be taken into consideration.

Magnetic induction

The illustration shows magnetic induction as a function of the distance to the actuating magnet. An oxide magnet made of barium ferrite with a 30 mm diameter and 10 mm in height (M 4.0) is used as the standard measure.

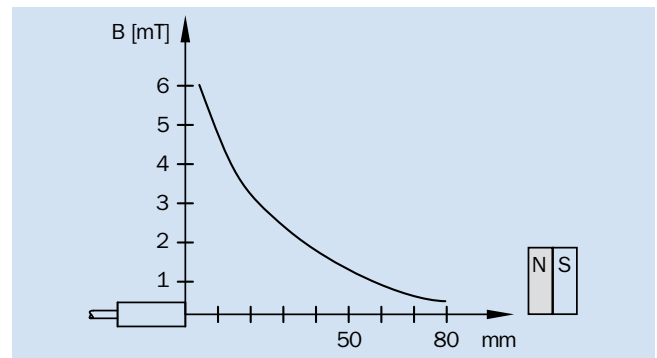

Approach curves

In the case of magnetic proximity sensors, it must be remembered that the alignment of the magnet relative to the sensor axis changes the operating distance.

A distinction can be made between the following cases:

Sensor and magnet axis are in alignment with each other

Case 1: The sensor responds as soon as the magnet reaches the switching curve. It can approach the proximity sensor axially or pass in front of the sensor inside the operating distance.

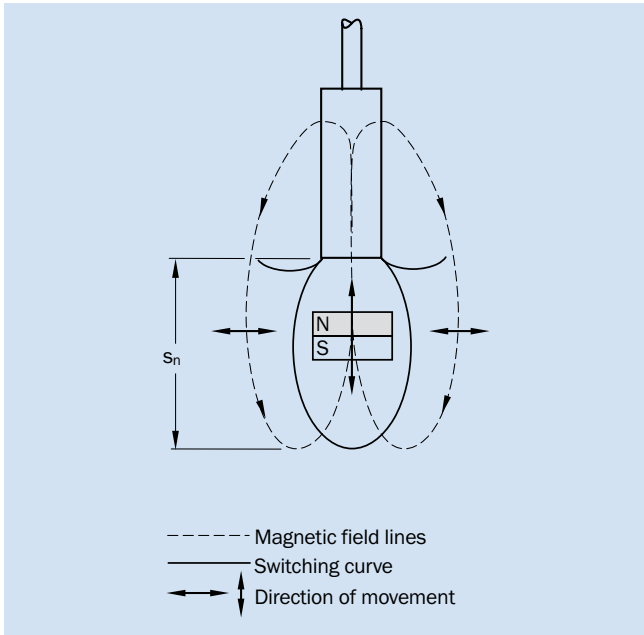

Case 2: The sensor responds if the magnet approaches the switching curve laterally. If the sensor leaves the switching curve, the sensor switches back again.

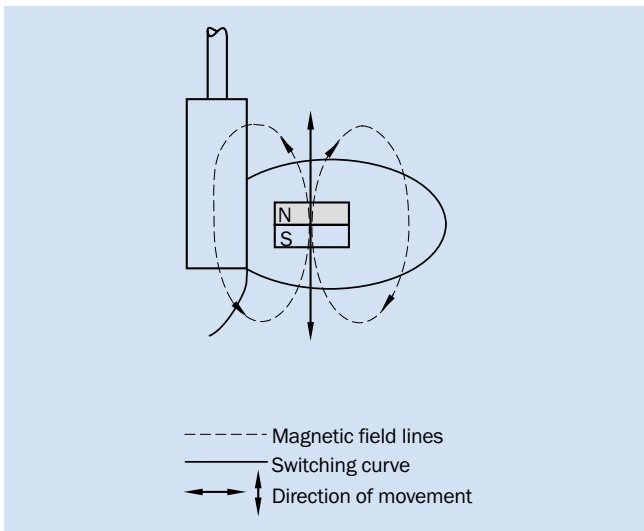

Sensor and magnet axis are offset by 90°

Case 3: If the magnet passes radially in front of the proximity sensor, the operating distance is smaller than that in the case 1. If, for example, the sensor enters the left-hand switching curve from the right-hand switching curve, it passes through an area in which the magnetic field is reversed. This briefly de-attenuates the proximity sensor before it is re-attenuated in the left-hand switching curve. Whether or not the evaluation unit can detect this interruption depends on the actuating speed and the axial distance of the traversing magnet.

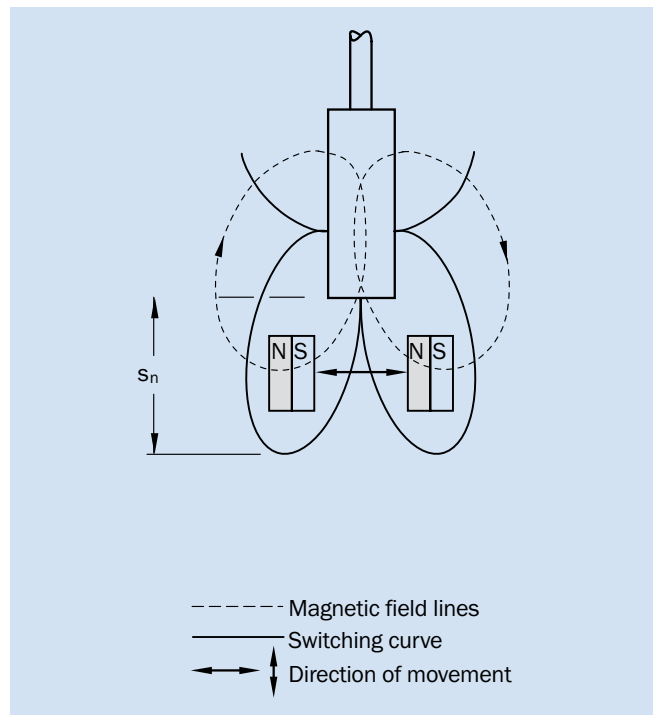

Magnetic proximity sensors

Case 4: In this case, the magnet passes through two switching curves. The magnetic field reverses at the boundary of these curves and two switching points are produced. The detection of this interruption again depends on the traverse speed and the radial distance relative to the sensor axis.

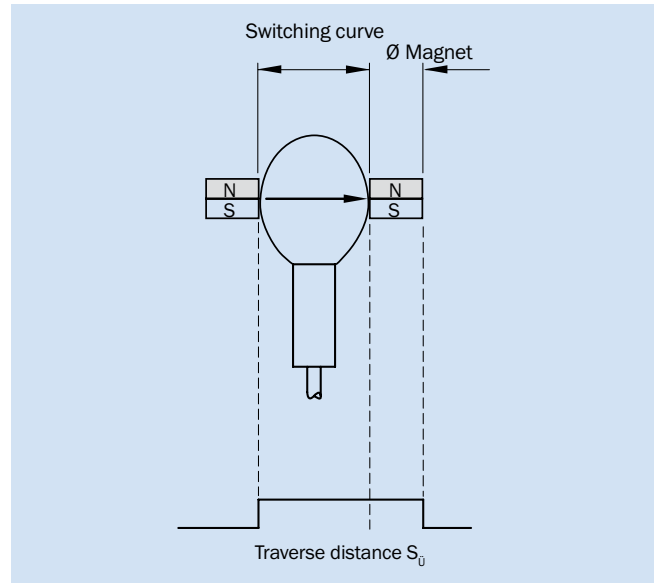
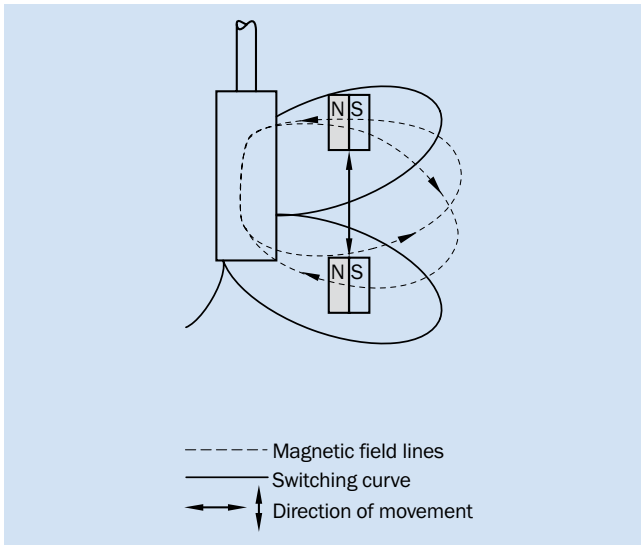

Traverse distance $S_{\bar{u}}$

The traverse distance $S_{\bar{u}}$ is the distance between the left- and right-hand boundary of the switching curve plus the diameter of the magnet. If a magnet approaches the switching curve from the left-hand side, the sensor responds. If the magnet leaves the switching curve at the opposite side, the sensor only switches if the magnet has completely left the envelope curve.

Installation notes

Flush sensor installation

Magnetic proximity sensors can be installed flush in all materials and metals (with the exception of magnetizable material) without any detrimental effects to the operating distance.

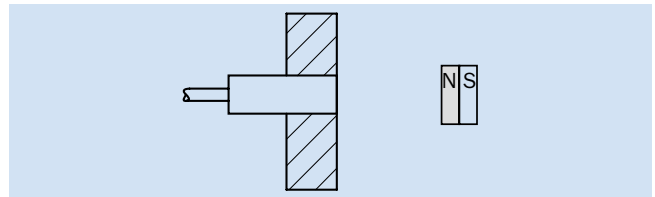

Non-flush sensor installation

The table shows how much the proximity sensor must protrude when installed in magnetizable material so that a reduction in operating distance of more than 5 % is avoided.

Standard measure MAG-3010-B (M 4.0)

Model name	Free zone (a)
MM08-60A-...	10 mm
MM12-60A-...	10 mm
MM18-70A-...	15 mm
MQ10-60A-...	10 mm

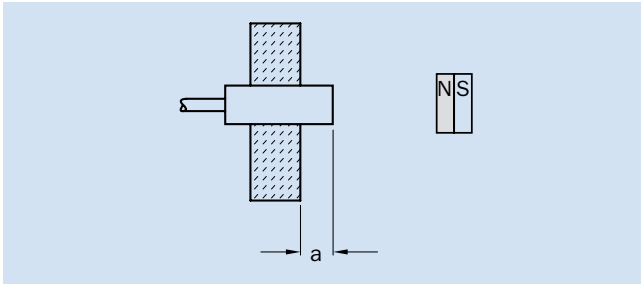

Mounting on magnetizable material

If the magnets are mounted on magnetizable material, the operating distance increases.

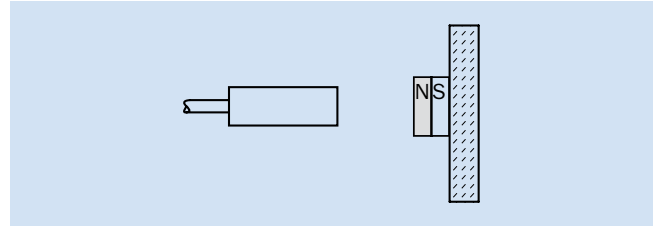

Flush magnet installation

The operating distance is reduced up to 60 % if the magnets are installed in magnetizable material.

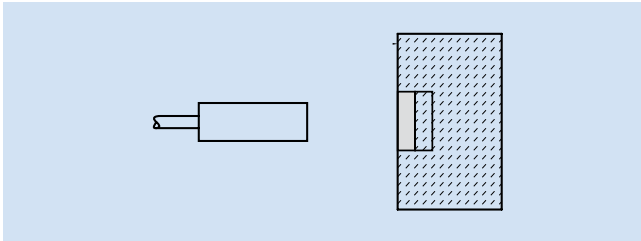

Penetration of material

Since magnetic fields penetrate all non-magnetizable material, magnetic proximity sensors can be used to detect magnets e.g. behind a non-ferrous metal, plastic, or wooden panel.

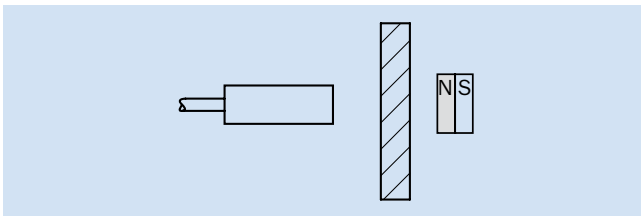

Just a few steps to the right magnetic proximity sensor

	MM08	MM12	MM18	MM12 Namur	MM18 Namur	MQ10
Which design is required?						
Cylindrical threaded						
Rectangular						
What size is required?						
M8						
M12						
M18						
10.3 x 28 x 16 mm						
What maximum sensing range is required?						
≤ 60 mm						
≤ 90 mm						
≤ 120 mm						
What output type is required?						
DC 3-wire						
Namur						
What housing material should the sensor have?						
Plastic						
Nickel-plated brass						
Stainless steel V2A						
What type of connection is required?						
Connector						
Cable						
From page	10	10	10	20	20	28
SICK can also offer customized solutions. You can find more information in Chapter F.						

Magnetic proximity sensor sensing ranges at a glance

Product family	Max. sensing range (mm) ¹⁾													Page	
	5	10	20	30	40	50	60	70	80	90	100	110	120		
MM08	5 mm ... 60 mm														10
MM12	5 mm ... 90 mm													10	
MM18	5 mm ... 120 mm													10	
MM12 Namur	5 mm ... 90 mm													20	
MM18 Namur	5 mm ... 120 mm													20	
MQ10	5 mm ... 60 mm													28	

¹⁾ Sensing range based on installation in non-magnetic material using Magnet MAG-3010-B (M4.0).

Product family overview



MM

Magnetic proximity sensors in common M8, M12, and M18 cylindrical housing

Technical data overview

Housing	Cylindrical
Thread size	M8 x 1 M12 x 1 M18 x 1
Housing	-
Sensing range S_n	60 mm ... 120 mm
Magnetic field sensitivity, min.	0.4 mT ... 1 mT
Housing material	Nickel-plated brass, stainless steel (V4A)
Enclosure rating	IP 67
Connection	Connector M8, 3-pin / Cable, 3-wire / Connector M12, 4-pin

At a glance

- Reliable detection of permanent magnets through non-ferromagnetic materials such as stainless steel, aluminum, plastic or wood
- Precise switching point and exact hysteresis
- Reliable object detection in high temperature zones
- Small housing with large operating distances
- Resistant to dust, dirt, and vibrations, increasing sensor life and reducing maintenance costs

Detailed information

→ 10



MM Namur

Namur magnetic proximity sensors in a cylindrical housing for explosive areas



MQ

Magnetic proximity sensors in a rectangular housing

	Cylindrical	Rectangular
	M12 x 1 M18 x 1	-
	-	10.3 mm x 37 mm x 16 mm 10.3 mm x 28 mm x 16 mm
	60 mm ... 120 mm	60 mm
	0.4 mT ... 1 mT	1 mT
	Nickel-plated brass	Polyamid
	IP 67	IP 67
	Connector M12, 4-pin / Cable, 2-wire / Cable, 4-wire	Connector M8, 3-pin / Cable, 3-wire / Cable with connector M8, 4-pin

- Detection of permanent magnets through non-ferromagnetic materials, such as stainless steel, aluminum, plastic or wood
- Namur design for usage in hazardous explosive areas
- Suitable for object detection in high temperature areas due to long sensing ranges
- Fits on to standard M12 and M18 installation

→ 20

- Long sensing distance in a small, compact rectangular plastic housing with an IP 67 enclosure rating
- Detection of permanent magnets through non-ferromagnetic materials such as stainless steel, aluminum, plastic, or wood
- Solves high-temperature applications by installing the temperature-resistant magnet in the high-temperature area and the sensor behind an insulated area
- Non-contact operation that is resistant to dust, dirt, shock and vibration
- Precise switching point and hysteresis
- Sensing distance up to 60 mm
- High switching frequency
- Short-circuit, reverse polarity protection and power-up pulse suppression

→ 28

Magnetic proximity sensors in common M8, M12, and M18 cylindrical housing



Product description

MM magnetic proximity sensors provide long sensing ranges that can reliably detect magnetic objects. Magnetic proximity sensors are resistant to dust, heat, vibrations and other harsh environ-

ments. The MM magnetic sensors are enclosed in a cylindrical housing and are available in sizes MM08, MM12 and MM18.

At a glance

- Reliable detection of permanent magnets through non-ferromagnetic materials such as stainless steel, aluminum, plastic or wood
- Precise switching point and exact hysteresis
- Reliable object detection in high temperature zones
- Small housing with large operating distances
- Resistant to dust, dirt, and vibrations, increasing sensor life and reducing maintenance costs

Your benefits

- Non-contact operation eliminates interference from dirt, dust and vibrations, increasing sensor life and reducing maintenance costs
- Space-saving installation due to small design
- Large operating distances with reliable switching increase throughput
- Non-contact, universal detection through several substances, including plastic containers and pipes protective PTFE walls and non-magnetic metal walls



Additional information

Detailed technical data 11

Ordering information 12

Dimensional drawings 13

Connection diagram 15

Maximum sensing range 15

Recommended accessories 17

→ www.mysick.com/en/MM
 For more information, just enter the link or scan the QR code and get direct access to technical data, CAD design models, operating instructions, software, application examples and much more.



Detailed technical data

Features

		MM08	MM12	MM18
Housing		M8 x 1	M12 x 1	M18 x 1
Sensing range S_n	Standard ¹⁾	0 mm ... 60 mm		0 mm ... 70 mm
	Advanced ¹⁾	-	5 mm ... 90 mm	5 mm ... 120 mm
Assured sensing range S_a	Standard	48.6 mm		56.7 mm
	Advanced	-	72.9 mm	97.2 mm
Magnetic sensitivity	Standard	1 mT		0.7 mT
	Advanced	-	0.6 mT	0.4 mT
Switching frequency	Standard	1,000 Hz		
	Advanced	-	5,000 Hz	
Output type		PNP / NPN		
Output function		NO		NO / NC
Electrical wiring		DC 3-wire		
Enclosure rating ²⁾		IP 67		
Magnetic alignment		Axial		

¹⁾ Sensing range based on installation in non-magnetic material using Magnet MAG-3010-B (M4.0).

²⁾ According to EN60529.

Mechanical / electrical

		MM08	MM12	MM18
Supply voltage		10 V DC ... 30 V DC		
Ripple ¹⁾		≤ 10 %		
Voltage drop	Standard	≤ 2 V ²⁾		
	Advanced	-	≤ 1.5 V ²⁾	
Current consumption ³⁾		≤ 10 mA		
Time delay before availability	Standard	≤ 20 ms		
	Advanced	-	≤ 2 ms	
Hysteresis		1 % ... 10 %		
Repeatability ⁴⁾		≤ 1 %		
Temperature drift (% of S_p)		± 10 %		
EMC		According to EN 60947-5-2		
Output current I_a	Standard	≤ 200 mA		
	Advanced	-	≤ 300 mA	

¹⁾ Of V_s .

²⁾ At I_a max.

³⁾ Without load.

⁴⁾ Von Sr (VS und Ta constant).

⁵⁾ Do not bend below 0 °C.

⁶⁾ Pulsed.

	MM08	MM12	MM18
Connection type	Cable, 2 m, PUR/PVC ⁵⁾ / Connector M8, 3-pin	Cable, 2 m, PUR/PVC ⁵⁾ / Connector M12, 4-pin	
Short-circuit protection⁶⁾	✓		
Reverse polarity protection	✓		
Power-up pulse protection	✓		
Shock/vibration	30 g, 11 ms/10 ... 55 Hz, 1 mm		
Ambient operating temperature	-25 °C ... +75 °C		
Housing material	Metal, Nickel-plated brass	Stainless steel, V4A / Nickel-plated brass	
Tightening torque, max.			
	Standard	6 Nm	15 Nm
	Advanced	–	7 Nm
			40 Nm
			25 Nm

¹⁾ Of V_s .

²⁾ At I_a max.

³⁾ Without load.

⁴⁾ Von Sr (VS und Ta constant).

⁵⁾ Do not bend below 0 °C.

⁶⁾ Pulsed.

Ordering information

MM08

- **Housing:** M8 x 1
- **Housing material:** Nickel-plated brass

Sensing range S_n ¹⁾	Output type	Housing	Output function	Connection	Connection diagram	Model name	Part no.
0 mm ... 60 mm	PNP	Standard	NO	Cable, 3-wire, 2 m, PUR/PVC	Cd-001	MM08-60APS-ZUK	1040027
				Connector M8, 3-pin	Cd-002	MM08-60APS-ZTK	1040067
	NPN	Standard	NO	Cable, 3-wire, 2 m, PUR/PVC	Cd-001	MM08-60ANS-ZUK	1040066
				Connector M8, 3-pin	Cd-002	MM08-60ANS-ZTK	1040068

¹⁾ Sensing range based on installation in non-magnetic material using Magnet MAG-3010-B (M4.0).

MM12

- **Housing:** M12 x 1
- **Housing material:** Nickel-plated brass

Sensing range S_n ¹⁾	Output type	Housing	Output function	Connection	Connection diagram	Model name	Part no.
0 mm ... 60 mm	PNP	Standard	NO	Cable, 3-wire, 2 m, PUR/PVC	Cd-002	MM12-60APS-ZUK	1040069
				Connector M12, 4-pin	Cd-011	MM12-60APS-ZCK	1040070
			NC	Cable, 3-wire, 2 m, PUR/PVC	Cd-003	MM12-60APO-ZUK	1040065
	NPN	Standard	NO	Cable, 3-wire, 2 m, PUR/PVC	Cd-002	MM12-60ANS-ZUK	1040026
				Connector M12, 4-pin	Cd-011	MM12-60ANS-ZCK	1040071
			PNP	Advanced	NO	Cable, 3-wire, 2 m, PUR/PVC	Cd-001
Connector M12, 4-pin	Cd-011	MM12-90APS-ZC0				1029950	
5 mm ... 90 mm	NPN	Advanced	NO	Cable, 3-wire, 2 m, PUR/PVC	Cd-001	MM12-90ANS-ZU0	1051013

¹⁾ Sensing range based on installation in non-magnetic material using Magnet MAG-3010-B (M4.0).

MM18

- Housing: M18 x 1

Sensing range ¹⁾	Output type	Housing	Output function	Connection	Housing material	Connection diagram	Model name	Part no.
0 mm ... 70 mm	PNP	Standard	NO	Cable, 3-wire, 2 m, PUR/PVC	Nickel-plated brass	Cd-001	MM18-70APS-ZUK	1040029
				Connector M12, 4-pin	V4A	Cd-011	MM18-70APS-VCK	1050765
			NC	Connector M12, 4-pin	Nickel-plated brass	Cd-011	MM18-70APS-ZCK	1040072
				Connector M12, 4-pin	Nickel-plated brass	Cd-031	MM18-70APO-ZCK	1047255
	NPN	Standard	NO	Cable, 3-wire, 2 m, PUR/PVC	Nickel-plated brass	Cd-001	MM18-70ANS-ZUK	1040085
				Connector M12, 4-pin	Nickel-plated brass	Cd-011	MM18-70ANS-ZCK	1040073
5 mm ... 120 mm	PNP	Advanced	NO	Cable, 3-wire, 2 m, PUR/PVC	Nickel-plated brass	Cd-001	MM18-00APS-ZUO	1029952
				Connector M12, 4-pin	Nickel-plated brass	Cd-011	MM18-00APS-ZCO	1029861

¹⁾ Sensing range based on installation in non-magnetic material using Magnet MAG-3010-B (M4.0).

Dimensional drawings

MM08-60Axx-xTx, M8, connector

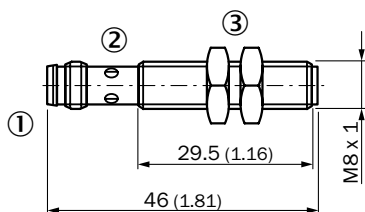

All dimensions in mm (inch)

- ① Connection
- ② LED indicator
- ③ Fastening nuts (2 x); width across 13, plastic

MM08-60APS-xUx, M8, cable

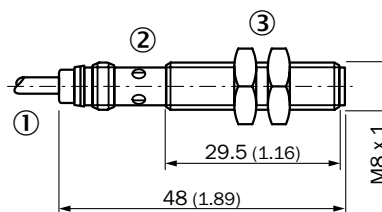

All dimensions in mm (inch)

- ① Connection
- ② LED indicator
- ③ Fastening nuts (2 x); width across 13, plastic

MM12-60Axx-xUK, M12, Sn = 60 mm, cable

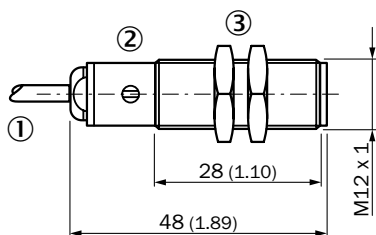

All dimensions in mm (inch)

- ① Connection
- ② LED indicator
- ③ Fastening nuts (2 x); width across 17, metal

MM12-60Axx-xCK, M12, Sn = 60 mm, connector

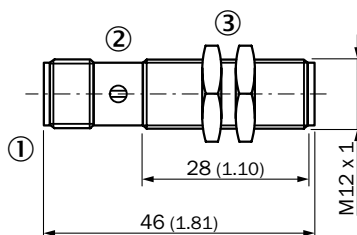

All dimensions in mm (inch)

- ① Connection
- ② LED indicator
- ③ Fastening nuts (2 x); width across 17, metal

MM12-90Axx-xC0,
M12, Sn = 90 mm, connector

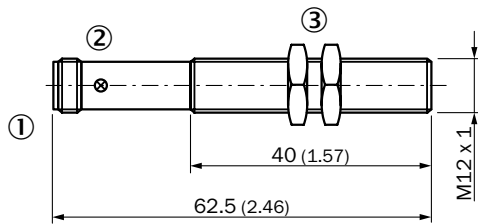

All dimensions in mm (inch)

- ① Connection
- ② LED indicator
- ③ Fastening nuts (2 x); width across 17, metal

MM12-90Axx-xU0,
M12, Sn = 90 mm, cable

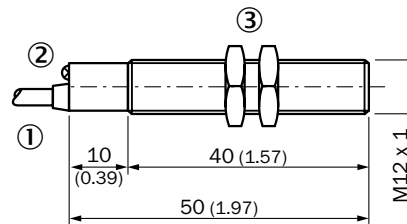

All dimensions in mm (inch)

- ① Connection
- ② LED indicator
- ③ Fastening nuts (2 x); width across 17, metal

MM18-70Axx-xCK,
M18, Sn = 70 mm, connector

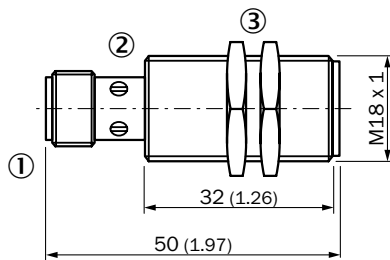

All dimensions in mm (inch)

- ① Connection
- ② LED indicator
- ③ Fastening nuts (2 x); width across 17, metal

MM18-70Axx-xUK,
M18, Sn = 70 mm, cable

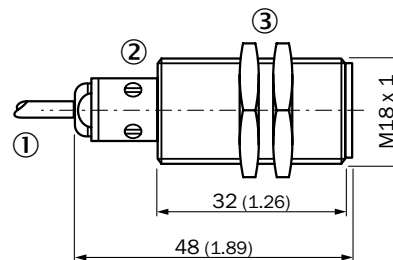

All dimensions in mm (inch)

- ① Connection
- ② LED indicator
- ③ Fastening nuts (2 x); 24 mm hex, metal

MM18-00Axx-xC0,
M18, Sn = 120 mm, connector

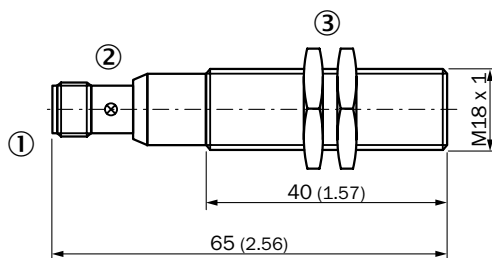

All dimensions in mm (inch)

- ① Connection
- ② LED indicator
- ③ Fastening nuts (2 x); width across 17, metal

MM18-00Axx-xU0,
M18, Sn = 120 mm, cable

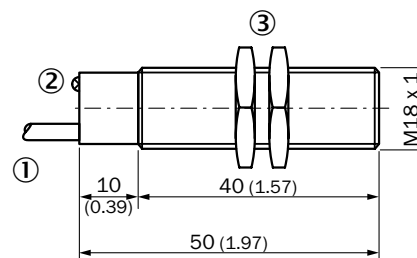

All dimensions in mm (inch)

- ① Connection
- ② LED indicator
- ③ Fastening nuts (2 x); width across 17, metal

Connection diagram

Cd-001

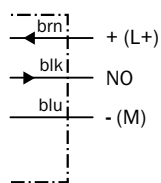

Cd-002

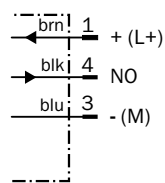

Cd-003

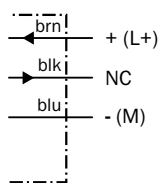

Cd-011

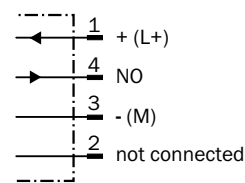

Cd-031

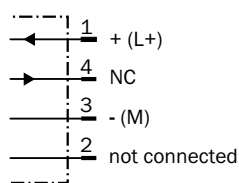

Maximum sensing range

MMxx-60Axx-xxx,
Sn = 60 mm

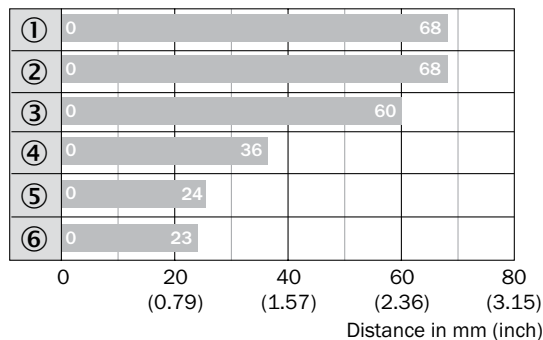

■ Max. sensing range S_n , flush or non-flush installation, non-magnetizable material

Magnet type	Part no.
① MAG-3315-B (M 5.1)	7902086
② MAG-3015-B (M 5.0)	7901786
③ MAG-3010-B (M 4.0)	7901785
④ MAG-2006-B (M 3.0)	7901784
⑤ MAG-0625-A (M 2.0)	7901783
⑥ MAG-1003-S (M 1.0)	7901782

MMxx-90Axx-xxx,
Sn = 90 mm

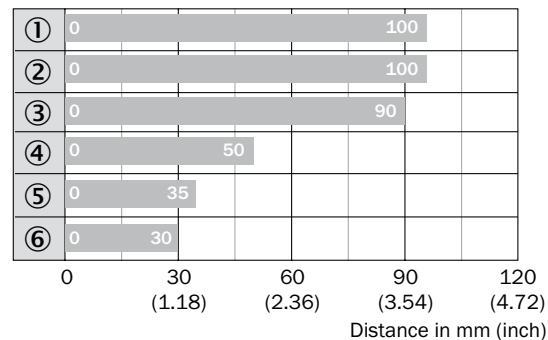

■ Max. sensing range S_n , flush or non-flush installation, non-magnetizable material

Magnet type	Part no.
① MAG-3315-B (M 5.1)	7902086
② MAG-3015-B (M 5.0)	7901786
③ MAG-3010-B (M 4.0)	7901785
④ MAG-2006-B (M 3.0)	7901784
⑤ MAG-0625-A (M 2.0)	7901783
⑥ MAG-1003-S (M 1.0)	7901782

MMxx-70Axx-xxx,
Sn = 70 mm

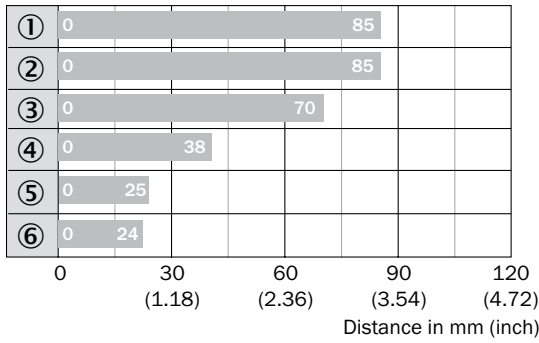

■ Max. sensing range S_n , flush or non-flush installation, non-magnetizable material

MMxx-00Axx-xxx,
Sn = 120 mm

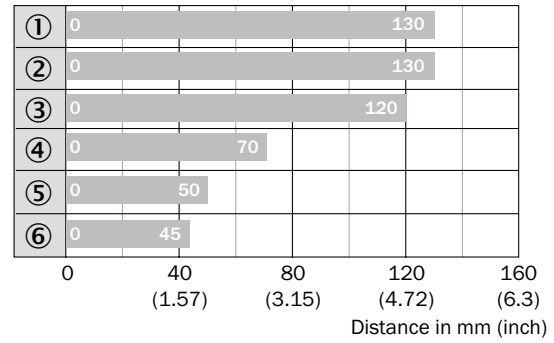

■ Max. sensing range S_n , flush or non-flush installation, non-magnetizable material





Magnet type	Part no.
① MAG-3315-B (M 5.1)	7902086
② MAG-3015-B (M 5.0)	7901786
③ MAG-3010-B (M 4.0)	7901785
④ MAG-2006-B (M 3.0)	7901784
⑤ MAG-0625-A (M 2.0)	7901783
⑥ MAG-1003-S (M 1.0)	7901782

Magnet type	Part no.
① MAG-3315-B (M 5.1)	7902086
② MAG-3015-B (M 5.0)	7901786
③ MAG-3010-B (M 4.0)	7901785
④ MAG-2006-B (M 3.0)	7901784
⑤ MAG-0625-A (M 2.0)	7901783
⑥ MAG-1003-S (M 1.0)	7901782

Recommended accessories

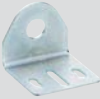







Mounting brackets

- **Accessory type:** Mounting brackets
- **Material:** Steel, zinc coated

Figure	Thread size	Configuration	Model name	Part no.	MM08	MM12	MM18
	M8	Straight	BEF-WG-M08	5321722	●	-	-
		Right angle	BEF-WN-M08	5321721	●	-	-
	M12	Straight	BEF-WG-M12	5321869	-	●	-
		Right angle	BEF-WN-M12	5308447	-	●	-
	M18	Straight	BEF-WG-M18	5321870	-	-	●
		Right angle	BEF-WN-M18	5308446	-	-	●







Cordsets and connectors

Connector M12, 4-pin

Figure	Connector type	Configuration	Enclosure rating	Jacket material	Cable length	Model name	Part no.	MM08	MM12	MM18	
	Female connector	Straight	IP 67	PVC	2 m	DOL-1204-G02M	6009382	-	●	●	
5 m					DOL-1204-G05M	6009866	-	●	●		
			IP 68	PUR halogen free	2 m	DOL-1204-G02MC	6025900	-	●	●	
5 m					DOL-1204-G05MC	6025901	-	●	●		
		Right angle	IP 67	PVC	2 m	DOL-1204-W02M	6009383	-	●	●	
5 m					DOL-1204-W05M	6009867	-	●	●		
					IP 68	PUR halogen free	2 m	DOL-1204-W02MC	6025903	-	●
5 m			DOL-1204-W05MC	6025904			-	●	●		
			Straight	IP 67			PBT	-	DOS-1204-G	6007302	-
					Right angle	PBT		-	DOS-1204-W	6007303	-
		Male connector	Straight	IP 67			PBT	-	STE-1204-G	6009932	-
					Right angle	PBT		-	STE-1204-W	6022084	-

Connector M8, 3-pin











- Enclosure rating: IP 67

Figure	Connector type	Configuration	Jacket material	Cable length	Model name	Part no.	MM08	MM12	MM18		
	Female connector	Straight	PVC	2 m	DOL-0803-G02M	6010785	●	-	-		
5 m				DOL-0803-G05M	6022009	●	-	-			
			PUR halogen free	2 m	DOL-0803-G02MC	6025888	●	-	-		
5 m				DOL-0803-G05MC	6025889	●	-	-			
		Right angle	IP 67	PVC	2 m	DOL-0803-W02M	6008489	●	-	-	
5 m					DOL-0803-W05M	6022010	●	-	-		
					IP 68	PUR halogen free	2 m	DOL-0803-W02MC	6025891	●	-
5 m			DOL-0803-W05MC	6025892			●	-	-		
			Straight	IP 67			PBT	-	DOS-0803-G	7902077	●
					Right angle	PBT		-	DOS-0803-W	7902078	●

Magnets

Figure	Diameter	Height	Material	Model name	Part no.	MM08	MM12	MM18
	36 mm	19.5 mm	Barium ferrite with plastic coating	MAG-3515-B (M 5.1)	7902086	●	●	●
	30 mm	15 mm	Barium ferrite	MAG-3015-B (M 5.0)	7901786	●	●	●
		10 mm	Barium ferrite	MAG-3010-B (M 4.0)	7901785	●	●	●
	20 mm	6.5 mm	Strontium ferrite	MAG-2006-B (M 3.0)	7901784	●	●	●
	6 mm	25 mm	Aluminum-nickel-cobalt	MAG-0625-A (M 2.0)	7901783	●	●	●
	10 mm	3 mm	Samarium-cobalt	MAG-1003-S (M 1.0)	7901782	●	●	●

Terminal and alignment brackets

Figure	Description	Material	Thread size	Model name	Part no.	MM08	MM12	MM18
	Terminal brackets, without fixed stop	Plastic (PA12), glass-fiber reinforced	M8	BEF-KH-M08	2051477	●	-	-
			M12	BEF-KH-M12	2051479	-	●	-
			M18	BEF-KH-M18	2051481	-	-	●
	Terminal brackets, with fixed stop	Plastic (PA12), glass-fiber reinforced	M8	BEF-KHF-M08	2051478	●	-	-
			M12	BEF-KHF-M12	2051480	-	●	-
			M18	BEF-KHF-M18	2051482	-	-	●
	Universal bar clamp systems	Zinc plated steel (sheet), Diecast zinc (clamp)	M12	BEF-KHS-N05	2051611	-	●	-
			M18	BEF-KHS-N06	2051612	-	-	●
		Stainless steel 1.4571 (sheet), Stainless steel 1.4408 (clamp)	M12	BEF-KHS-N05N	2051621	-	●	-
			M18	BEF-KHS-N06N	2051622	-	-	●
		Steel, zinc coated	-	BEF-MS12G-A	4056054	-	●	●
		Stainless steel (1.4571)	-	BEF-MS12G-NA	4058914	-	●	●

Namur magnetic proximity sensors in a cylindrical housing for explosive areas



Product description

MM Namur magnetic proximity sensors provide large operating distances that can reliably detect magnetic objects. Magnetic proximity sensors are resistant to dust, heat and vibration, making them ideal for use in harsh environments –

even highly explosive atmospheres. By using magnetic conductors, these sensors are able to reliably detect objects over greater distances. The Namur design for hazardous areas is available in MM12 and MM18 designs.

At a glance

- Detection of permanent magnets through non-ferromagnetic materials, such as stainless steel, aluminum, plastic or wood
- Namur design for usage in hazardous explosive areas
- Suitable for object detection in high temperature areas due to long sensing ranges
- Fits on to standard M12 and M18 installation

Your benefits

- Namur design ensures safe operation in highly explosive areas
- Non-contact operation ensures resistance to dirt, dust and vibration, increasing sensor life and reducing maintenance costs
- Large operating distances ensure reliable switching, even with target position tolerances
- Non-contact, universal detection through several substances, including plastic containers and pipes and protective PTFE walls



Additional information

Detailed technical data 21

Ordering information 22

Dimensional drawings 22

Connection diagram 23

Maximum sensing range 23

Recommended accessories 24

→ www.mysick.com/en/MM_Namur
 For more information, just enter the link or scan the QR code and get direct access to technical data, CAD design models, operating instructions, software, application examples and much more.



Detailed technical data

Features

	MM12 Namur	MM18 Namur
Housing	M12 x 1	M18 x 1
Sensing range S_n	5 mm ... 60 mm ¹⁾ / 5 mm ... 90 mm ¹⁾	5 mm ... 70 mm ¹⁾ / 5 mm ... 120 mm ¹⁾
Assured sensing range S_a	48.6 mm / 72.9 mm	56.7 mm / 97.2 mm
Magnetic sensitivity	1 mT / 0.6 mT	0.7 mT / 0.4 mT
Switching frequency	5,000 Hz	
Output type	Namur	
Output function	Control current depending on switching state according to Namur EN 60947-5-6	
Enclosure rating ²⁾	IP 67	
Magnetic alignment	Axial	

¹⁾ Sensing range based on installation in non-magnetic material using Magnet MAG-3010-B (M4.0).

²⁾ According to EN60529.

Mechanical / electrical

	MM12 Namur	MM18 Namur
Ripple ¹⁾	≤ 5 %	
Time delay before availability	≤ 2 ms	
Hysteresis	1 % ... 10 %	
Repeatability ²⁾	≤ 1 %	
Temperature drift (% of S_p)	± 10 %	
EMC	According to EN 60947-5-2	
Current consumption, sensor is activated	≥ 2.5 mA	
Current consumption, sensor is not activated	≤ 1 mA	
Connection type	Connector M12, 4-pin / Cable, 2 m, PVC ³⁾ / Cable, 0.8 m	Connector M12, 4-pin / Cable, 2 m, PVC ³⁾
Wire-break protection	✓	
Short-circuit protection	✓	
Reverse polarity protection	✓	
Shock/vibration	30 g, 11 ms/10 ... 55 Hz, 1 mm	
Ambient operating temperature	-25 °C ... +75 °C	
Housing material	Metal, Nickel-plated brass	
Tightening torque, max.	≤ 7 Nm	≤ 25 Nm
EC Approval Certificate	TÜV 99 ATEX 1398	
ATEX marking	EX II 2G Ex ia IIC T6 Ta: -20 °C ... 70 °C	
Hazardous area category	2G	
Input voltage U_i max ⁴⁾	16 V	
Input power P_i max. ⁴⁾	100 mW	
Input current I_i max ⁴⁾	30 mA	
Internal capacitance C_i max. ⁴⁾	15 nF	
Internal inductance L_i max. ⁴⁾	35 µH	
Nominal voltage	8.2 V DC	

¹⁾ Of V_s .

²⁾ Von Sr (VS und Ta constant).

³⁾ Do not bend below 0 °C.

⁴⁾ For connection to a separately certified intrinsically safe circuit only.

Ordering information

MM12 Namur

- **Housing:** M12 x 1
- **Output type:** Namur

Sensing range S_n ¹⁾	Connection	Connection diagram	Model name	Part no.
5 mm ... 60 mm	Connector M12, 4-pin	Cd-015	MM12-60A-N-ZC0	7900287
	Cable, 2-wire, 2 m, PVC	Cd-012	MM12-60A-N-ZW0	7900286
5 mm ... 90 mm	Cable, 4-wire, 0.8 m	Cd-012	MM12-90A-N-ZUD	1046761

¹⁾ Sensing range based on installation in non-magnetic material using Magnet MAG-3010-B (M4.0).

MM18 Namur

- **Housing:** M18 x 1
- **Output type:** Namur

Sensing range S_n ¹⁾	Connection	Connection diagram	Model name	Part no.
5 mm ... 70 mm	Connector M12, 4-pin	Cd-015	MM18-70A-N-ZC0	7900289
	Cable, 2-wire, 2 m, PVC	Cd-012	MM18-70A-N-ZW0	7900288
5 mm ... 120 mm	Connector M12, 4-pin	Cd-015	MM18-00A-N-ZC0	1026614

¹⁾ Sensing range based on installation in non-magnetic material using Magnet MAG-3010-B (M4.0).

Dimensional drawings

MM12-60A-N-xCx,
M12, connector

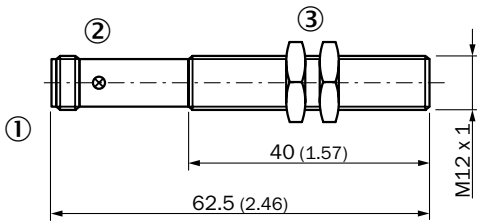

All dimensions in mm (inch)

- ① Connection
- ② LED indicator
- ③ Fastening nuts (2 x); width across 17, metal

MM12-60A-N-xUx,
M12, cable

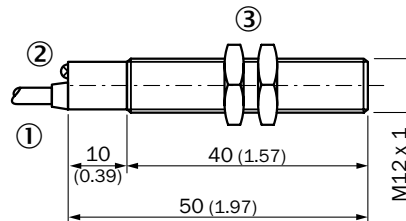

All dimensions in mm (inch)

- ① Connection
- ② LED indicator
- ③ Fastening nuts (2 x); width across 17, metal

Cylindrical threaded housing

MM18-70A-N-xCx,
M18, connector

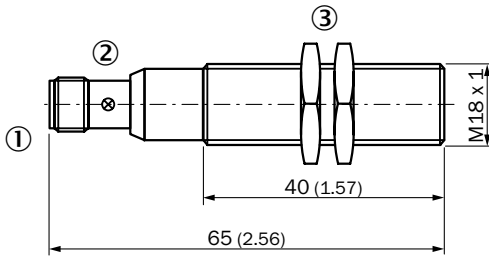

All dimensions in mm (inch)

- ① Connection
- ② LED indicator
- ③ Fastening nuts (2 x); width across 17, metal

MM18-70A-N-xWx,
M18, cable

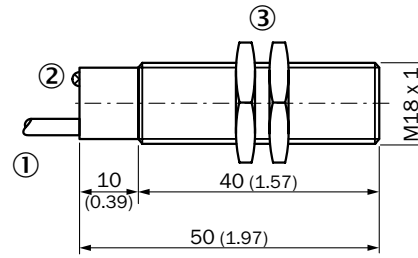

All dimensions in mm (inch)

- ① Connection
- ② LED indicator
- ③ Fastening nuts (2 x); width across 17, metal

Connection diagram

Cd-012

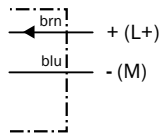

Cd-015

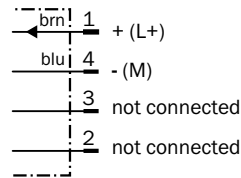

Maximum sensing range

MMxx-60Axx-xxx,
Sn = 60 mm

①	0	68
②	0	68
③	0	60
④	0	36
⑤	0	24
⑥	0	23

0 20 40 60 80
(0.79) (1.57) (2.36) (3.15)
Distance in mm (inch)

■ Max. sensing range S_n , flush or non-flush installation, non-magnetizable material

Magnet type	Part no.
① MAG-3315-B (M 5.1)	7902086
② MAG-3015-B (M 5.0)	7901786
③ MAG-3010-B (M 4.0)	7901785
④ MAG-2006-B (M 3.0)	7901784
⑤ MAG-0625-A (M 2.0)	7901783
⑥ MAG-1003-S (M 1.0)	7901782

MMxx-90Axx-xxx,
Sn = 90 mm

①	0	100
②	0	100
③	0	90
④	0	50
⑤	0	35
⑥	0	30

0 30 60 90 120
(1.18) (2.36) (3.54) (4.72)
Distance in mm (inch)

■ Max. sensing range S_n , flush or non-flush installation, non-magnetizable material

Magnet type	Part no.
① MAG-3315-B (M 5.1)	7902086
② MAG-3015-B (M 5.0)	7901786
③ MAG-3010-B (M 4.0)	7901785
④ MAG-2006-B (M 3.0)	7901784
⑤ MAG-0625-A (M 2.0)	7901783
⑥ MAG-1003-S (M 1.0)	7901782

MMxx-70Axx-xxx,
Sn = 70 mm

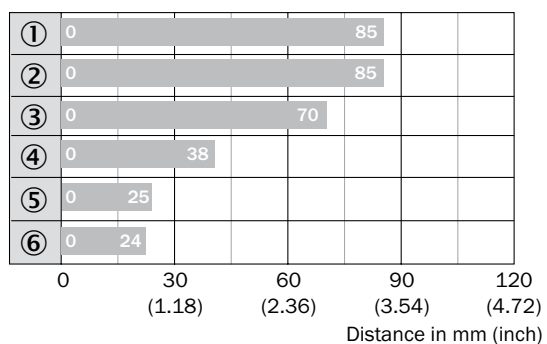

■ Max. sensing range S_n , flush or non-flush installation, non-magnetizable material

MMxx-00Axx-xxx,
Sn = 120 mm

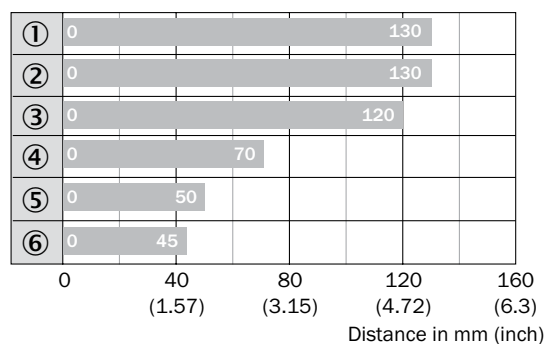

■ Max. sensing range S_n , flush or non-flush installation, non-magnetizable material

Magnet type	Part no.
① MAG-3315-B (M 5.1)	7902086
② MAG-3015-B (M 5.0)	7901786
③ MAG-3010-B (M 4.0)	7901785
④ MAG-2006-B (M 3.0)	7901784
⑤ MAG-0625-A (M 2.0)	7901783
⑥ MAG-1003-S (M 1.0)	7901782

Magnet type	Part no.
① MAG-3315-B (M 5.1)	7902086
② MAG-3015-B (M 5.0)	7901786
③ MAG-3010-B (M 4.0)	7901785
④ MAG-2006-B (M 3.0)	7901784
⑤ MAG-0625-A (M 2.0)	7901783
⑥ MAG-1003-S (M 1.0)	7901782

Recommended accessories







Mounting brackets

- **Accessory type:** Mounting brackets
- **Material:** Steel, zinc coated

Figure	Thread size	Configuration	Model name	Part no.	MM12 Namur	MM18 Namur
	M12	Straight	BEF-WG-M12	5321869	●	-
		Right angle	BEF-WN-M12	5308447	●	-
	M18	Straight	BEF-WG-M18	5321870	-	●
		Right angle	BEF-WN-M18	5308446	-	●

Cordsets and connectors









Connector M12, 4-pin

Figure	Connector type	Configuration	Enclosure rating	Jacket material	Cable length	Model name	Part no.	MM12 Namur	MM18 Namur	
	Female connector	Straight	IP 67	PVC	2 m	DOL-1204-G02M	6009382	●	●	
					5 m	DOL-1204-G05M	6009866	●	●	
IP 68			PUR halogen free	2 m	DOL-1204-G02MC	6025900	●	●		
				5 m	DOL-1204-G05MC	6025901	●	●		
		IP 67	PVC	IP 67	PVC	2 m	DOL-1204-W02M	6009383	●	●
						5 m	DOL-1204-W05M	6009867	●	●
		IP 68	PUR halogen free	IP 68	PUR halogen free	2 m	DOL-1204-W02MC	6025903	●	●
						5 m	DOL-1204-W05MC	6025904	●	●
		Straight	IP 67	IP 67	PBT	-	DOS-1204-G	6007302	●	●
						Right angle	PBT	-	DOS-1204-W	6007303
	Male connector	Straight	IP 67	PBT	-	STE-1204-G	6009932	●	●	
		Right angle			PBT	-	STE-1204-W	6022084	●	●

Magnets

Figure	Diameter	Height	Material	Model name	Part no.	MM12 Namur	MM18 Namur
	36 mm	19.5 mm	Barium ferrite with plastic coating	MAG-3515-B (M 5.1)	7902086	●	●
	30 mm	15 mm	Barium ferrite	MAG-3015-B (M 5.0)	7901786	●	●
		10 mm	Barium ferrite	MAG-3010-B (M 4.0)	7901785	●	●
	20 mm	6.5 mm	Strontium ferrite	MAG-2006-B (M 3.0)	7901784	●	●
	6 mm	25 mm	Aluminum-nickel-cobalt	MAG-0625-A (M 2.0)	7901783	●	●
	10 mm	3 mm	Samarium-cobalt	MAG-1003-S (M 1.0)	7901782	●	●

Terminal and alignment brackets

Figure	Description	Material	Thread size	Model name	Part no.	MM12	MM18
	Terminal brackets, without fixed stop	Plastic (PA12), glass-fiber reinforced	M12	BEF-KH-M12	2051479	●	-
			M18	BEF-KH-M18	2051481	-	●
	Terminal brackets, with fixed stop	Plastic (PA12), glass-fiber reinforced	M12	BEF-KHF-M12	2051480	●	-
			M18	BEF-KHF-M18	2051482	-	●
	Plate for universal bar clamp	Zinc plated steel (sheet), diecast zinc (clamp)	M12	BEF-KHS-N05	2051611	●	-
			M18	BEF-KHS-N06	2051612	-	●
		Stainless steel 1.4571 (sheet), Stainless steel 1.4408 (clamp)	M12	BEF-KHS-N05N	2051621	●	-
			M18	BEF-KHS-N06N	2051622	-	●
	Mounting rod, straight	Steel, zinc coated	-	BEF-MS12G-A	4056054	●	●
		Stainless steel (1.4571)	-	BEF-MS12G-NA	4058914	●	●

Magnetic proximity sensors in a rectangular housing

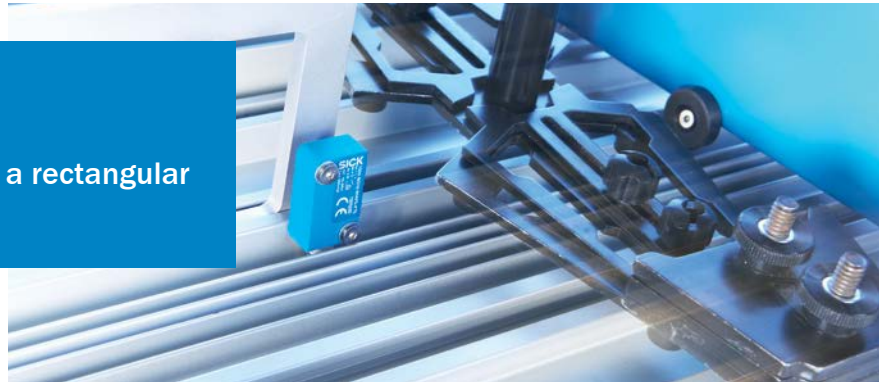

Product description

MQ magnetic proximity sensors reliably detect permanent magnets through non-ferromagnetic materials such as stainless steel, aluminum, plastic or wood. The MQ series features a square, com-

compact plastic housing that makes it easy to install. These sensors are resistant to dust, heat and vibration, making them ideal for use in harsh environments.

At a glance

- Long sensing distance in a small, compact rectangular plastic housing with an IP 67 enclosure rating
- Detection of permanent magnets through non-ferromagnetic materials such as stainless steel, aluminum, plastic, or wood
- Solves high-temperature applications by installing the temperature-resistant magnet in the high-temperature area and the sensor behind an insulated area
- Non-contact operation that is resistant to dust, dirt, shock and vibration
- Precise switching point and hysteresis
- Sensing distance up to 60 mm
- High switching frequency
- Short-circuit, reverse polarity protection and power-up pulse suppression

Your benefits

- Non-contact operation eliminates interference from dirt, dust, shock and vibrations, reducing maintenance costs
- Long sensing distance with reliable switching reduces miscounts and increases machine throughput
- Easy to install, low-cost sensor solution saves installation time and costs
- Compact plastic housing saves machine space



Additional information

Detailed technical data.....	29
Ordering information.....	30
Dimensional drawings.....	30
Connection diagram.....	30
Maximum sensing range.....	31
Recommended accessories.....	31

→ www.mysick.com/en/MQ

For more information, just enter the link or scan the QR code and get direct access to technical data, CAD design models, operating instructions, software, application examples and much more.



Detailed technical data

Features

Dimensions (W x H x D)	10.3 mm x 37 mm x 16 mm / 10.3 mm x 28 mm x 16 mm
Housing	Rectangular
Sensing range S_n ¹⁾	5 mm ... 60 mm
Assured sensing range S_a	48.6 mm
Magnetic sensitivity	1 mT
Switching frequency	5,000 Hz
Output type	NPN / PNP
Output function	NO
Electrical wiring	DC 3-wire
Enclosure rating ²⁾	IP 67
Magnetic alignment	Axial

¹⁾ Sensing range based on installation in non-magnetic material using Magnet MAG-3010-B (M4.0).

²⁾ According to EN60529.

Mechanical / electrical

Supply voltage	10 V DC ... 30 V DC
Ripple ¹⁾	≤ 10 %
Voltage drop ²⁾	≤ 1.5 V
Current consumption ³⁾	≤ 5 mA
Time delay before availability	≤ 2 ms
Hysteresis	1 % ... 10 %
Repeatability ⁴⁾	≤ 1 %
Temperature drift (% of S_p)	± 10 %
EMC	According to EN 60947-5-2
Output current I_a	≤ 300 mA
Connection type	Connector M8, 3-pin / Cable, 2 m, PUR/PVC ⁵⁾ / Cable with connector M8, 4-pin
Short-circuit protection ⁶⁾	✓
Reverse polarity protection	✓
Power-up pulse protection	✓
Shock/vibration	30 g, 11 ms/10 ... 55 Hz, 1 mm
Ambient operating temperature	-25 °C ... +75 °C
Housing material	Polyamid (PA)
Housing cap material	Polyamid (PA)

¹⁾ Of V_s .

²⁾ At I_a max.

³⁾ Without load.

⁴⁾ Von Sr (VS und Ta constant).

⁵⁾ Do not bend below 0 °C.

⁶⁾ Pulsed.

Ordering information

- Output function: NO

Sensing range S_{11} ¹⁾	Output type	Connection	Connection diagram	Model name	Part no.
5 mm ... 60 mm	NPN	Connector M8, 3-pin	Cd-002	MQ10-60ANS-KT0	7900281
		Cable, 3-wire, 2 m, PUR/PVC	Cd-001	MQ10-60ANS-KU0	7900279
	PNP	Connector M8, 3-pin	Cd-002	MQ10-60APS-KT0	7900280
		Cable, 3-wire, 2 m, PUR/PVC	Cd-001	MQ10-60APS-KU0	7900278
		Cable with connector M8, 4-pin	Cd-011	MQ10-60APS-KP0	1017405

¹⁾ Sensing range based on installation in non-magnetic material using Magnet MAG-3010-B (M4.0).

Dimensional drawings

MQ10-60Axx-xTx, connector

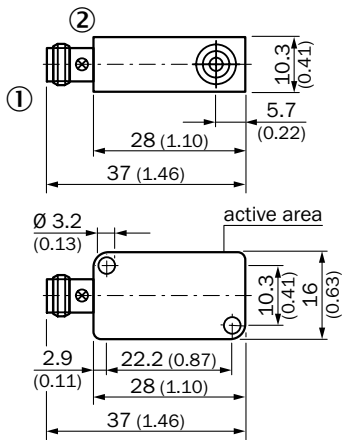

All dimensions in mm (inch)

- ① Connection
- ② LED indicator

MQ10-60Axx-xUx, MQ10-60Axx-xPx, cable, cable with connector

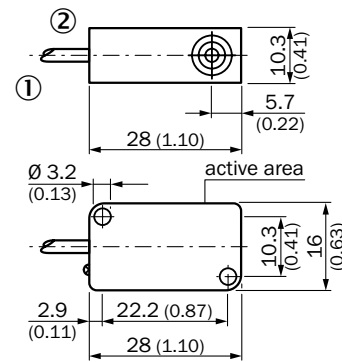

All dimensions in mm (inch)

- ① Connection
- ② LED indicator

Connection diagram

Cd-001

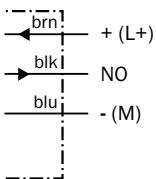

Cd-002

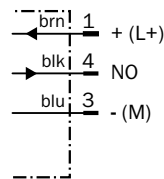

Cd-011

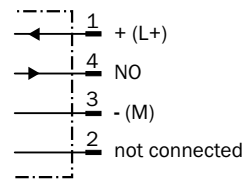

Maximum sensing range

MMxx-60Axx-xxx

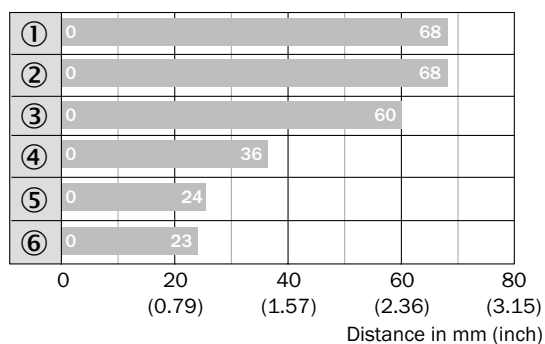

■ Max. sensing range S_n , flush or non-flush installation, non-magnetizable material





Magnet type	Part no.
① MAG-3315-B (M 5.1)	7902086
② MAG-3015-B (M 5.0)	7901786
③ MAG-3010-B (M 4.0)	7901785
④ MAG-2006-B (M 3.0)	7901784
⑤ MAG-0625-A (M 2.0)	7901783
⑥ MAG-1003-S (M 1.0)	7901782

Recommended accessories







Cordsets and connectors

Connector M8, 3-pin

- Enclosure rating: IP 67

Figure	Connector type	Configuration	Jacket material	Cable length	Model name	Part no.
	Female connector	Straight	PVC	2 m	DOL-0803-G02M	6010785
				5 m	DOL-0803-G05M	6022009
PUR halogen free			2 m	DOL-0803-G02MC	6025888	
			5 m	DOL-0803-G05MC	6025889	
		Right angle	PVC	2 m	DOL-0803-W02M	6008489
				5 m	DOL-0803-W05M	6022010
PUR halogen free			2 m	DOL-0803-W02MC	6025891	
			5 m	DOL-0803-W05MC	6025892	
	Straight		PBT	-	DOS-0803-G	7902077
	Right angle		PBT	-	DOS-0803-W	7902078

Magnets

Figure	Diameter	Height	Material	Model name	Part no.
	36 mm	19.5 mm	Barium ferrite with plastic coating	MAG-3515-B (M 5.1)	7902086
	30 mm	15 mm	Barium ferrite	MAG-3015-B (M 5.0)	7901786
		10 mm	Barium ferrite	MAG-3010-B (M 4.0)	7901785
	20 mm	6.5 mm	Strontium ferrite	MAG-2006-B (M 3.0)	7901784
	6 mm	25 mm	Aluminum-nickel-cobalt	MAG-0625-A (M 2.0)	7901783
	10 mm	3 mm	Samarium-cobalt	MAG-1003-S (M 1.0)	7901782

www.mysick.com – search online and order

Search online quickly and safely – with the SICK “Finders”

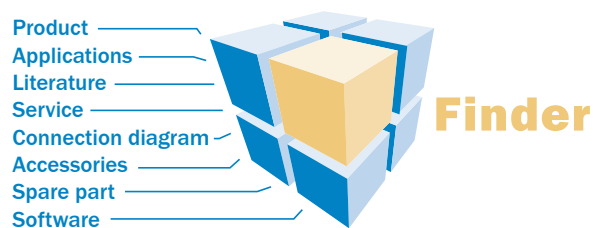

Product Finder: We can help you to quickly target the product that best matches your application.

Applications Finder: Select the application description on the basis of the challenge posed, industrial sector, or product group.

Literature Finder: Go directly to the operating instructions, technical information, and other literature on all aspects of SICK products.

Efficiency – with the e-commerce tools from SICK

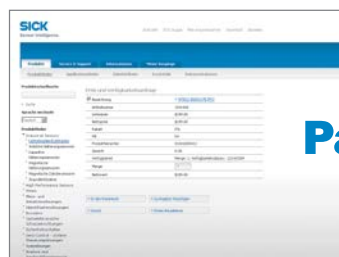

Find out prices and availability: Determine the price and possible delivery date of your desired product simply and quickly at any time.

Request or view a quote: You can have a quote generated online here. Every quote is confirmed to you via e-mail.

Order online: You can go through the ordering process in just a few steps.

SICK at a glance

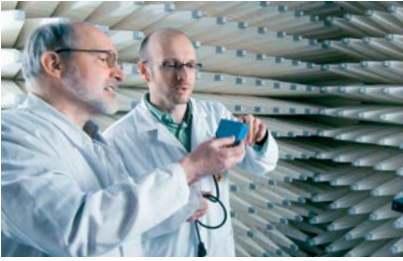

Leading technologies

With a staff of more than 5,800 and nearly 50 subsidiaries and representations worldwide, SICK is one of the leading and most successful manufacturers of sensor technology. The power of innovation and solution competency have made SICK the global market leader. No matter what the project and industry may be, talking with an expert from SICK will provide you with an ideal basis for your plans – there is no need to settle for anything less than the best.



Unique product range

- Non-contact detecting, counting, classifying, positioning and measuring of any type of object or media
- Accident and operator protection with sensors, safety software and services
- Automatic identification with bar code and RFID readers
- Laser measurement technology for detecting the volume, position and contour of people and objects
- Complete system solutions for analysis and flow measurement of gases and liquids



Comprehensive services

- SICK LifeTime Services – for safety and productivity
- Application centers in Europe, Asia and North America for the development of system solutions under real-world conditions
- E-Business Partner Portal www.mysick.com – price and availability of products, requests for quotation and online orders

Worldwide presence with subsidiaries in the following countries:

Australia
Belgium/Luxembourg
Brasil
Česká Republika
Canada
China
Danmark
Deutschland
España
France
Great Britain
India
Israel
Italia
Japan

México
Nederland
Norge
Österreich
Polska
România
Russia
Schweiz
Singapore
Slovenija
South Africa
South Korea
Suomi
Sverige
Taiwan
Türkiye
United Arab Emirates
USA

Please find detailed addresses and additional representatives and agencies in all major industrial nations at www.sick.com