

YY WW = date code

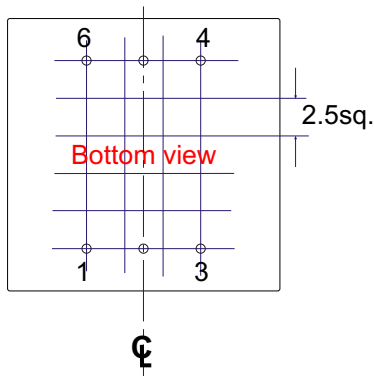

Tolerance on all hole positions +/-0.2mm
 Pin diameter = 0.6mm
 Recommended PCB hole size: 1.0mm

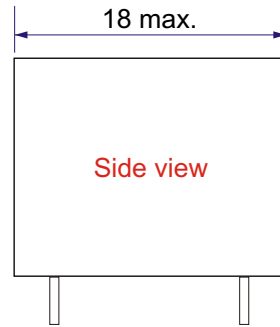
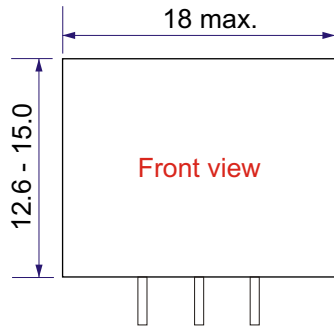
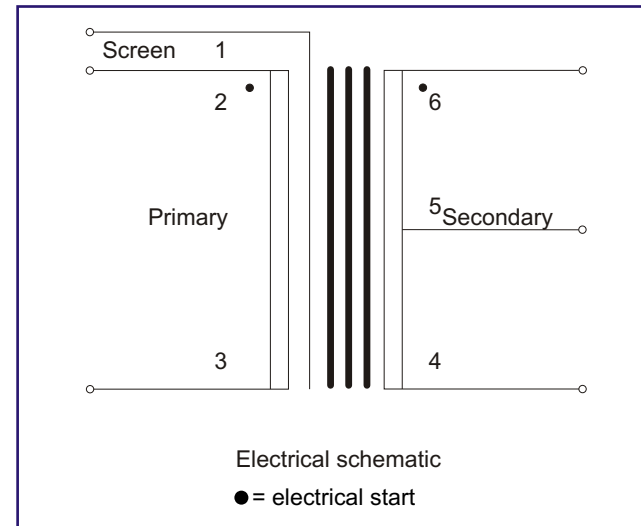

Specification:

Primary impedance: 600

Turns ratio: 1 to 1.22 C.T.

DC resistance (+/-15%)

Primary (2 - 3): 117

Secondary (6 - 4): 180

Inductance @ 0.10V, 1kHz, series equivalent

Primary: 7.5H minimum

Primary leakage inductance @ 1kHz, 0.10V: 3.4mH (typical)

Interwinding capacitance @ 20kHz, 0.1V: 19pF (typical)

Hi-pot, primary to secondary: 1kVAC for 2 seconds

Operating temperature range: -20°C to +75°C

Storage temperature range: -40°C to +125°C

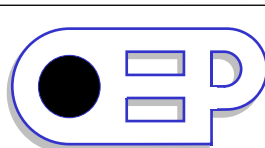

Unit 5, Oxonian Park, Langford Locks,
 Kidlington, Oxfordshire. OX5 1FP
 Tel: (01865) 855085 Fax: (01865) 855075
 Website: www.oep.co.uk

DESCRIPTION	ISSUE	DATE	DRAWN	CHECKED	DRAWING NUMBER
1:1.22 C.T. 600 audio transformer with interwinding screen page 1 of 2	1	11/09/13	CS		Z1686E
	2	04/11/13	CS		
Scale: nts					

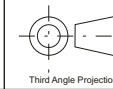

All dimensions in mm unless stated otherwise

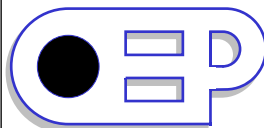
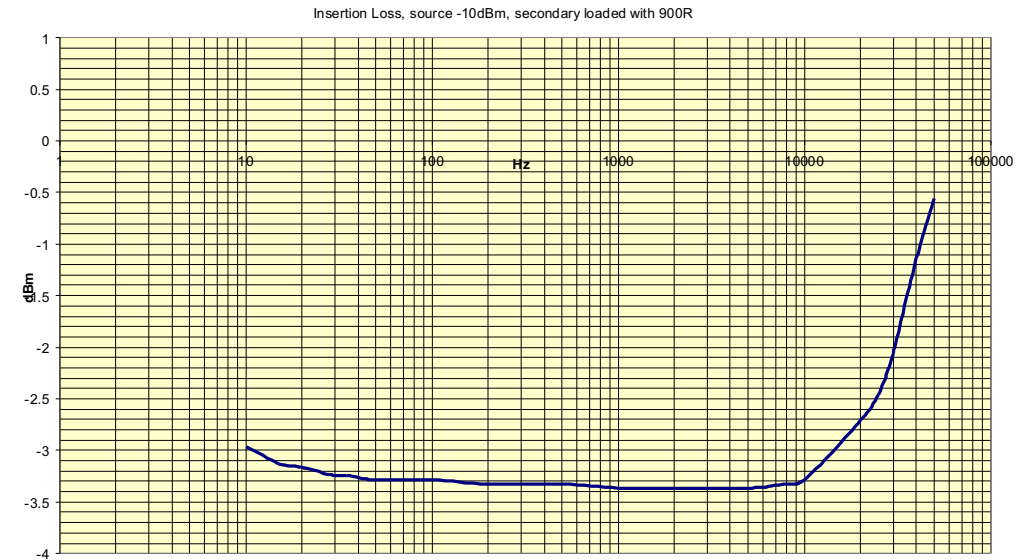
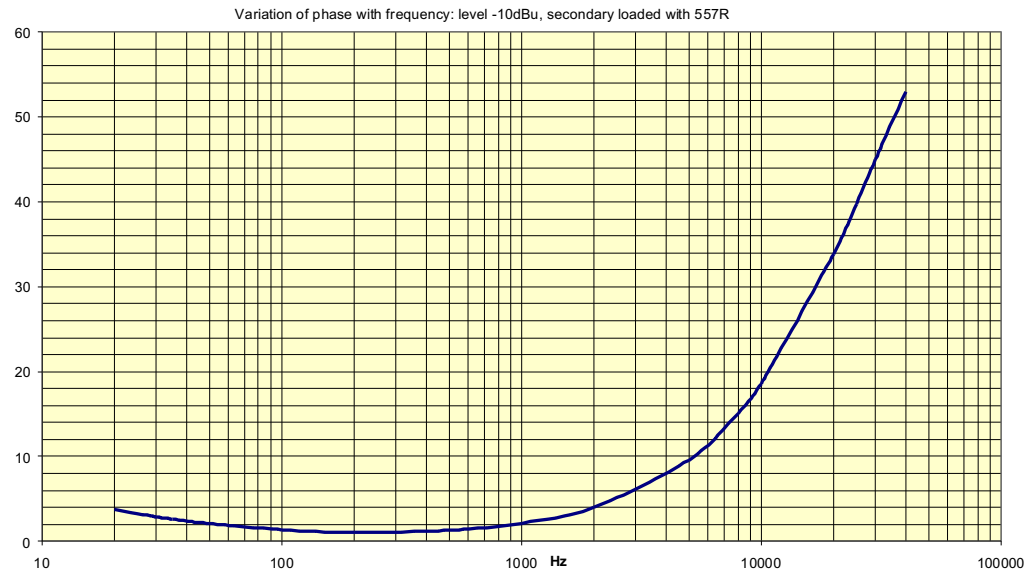
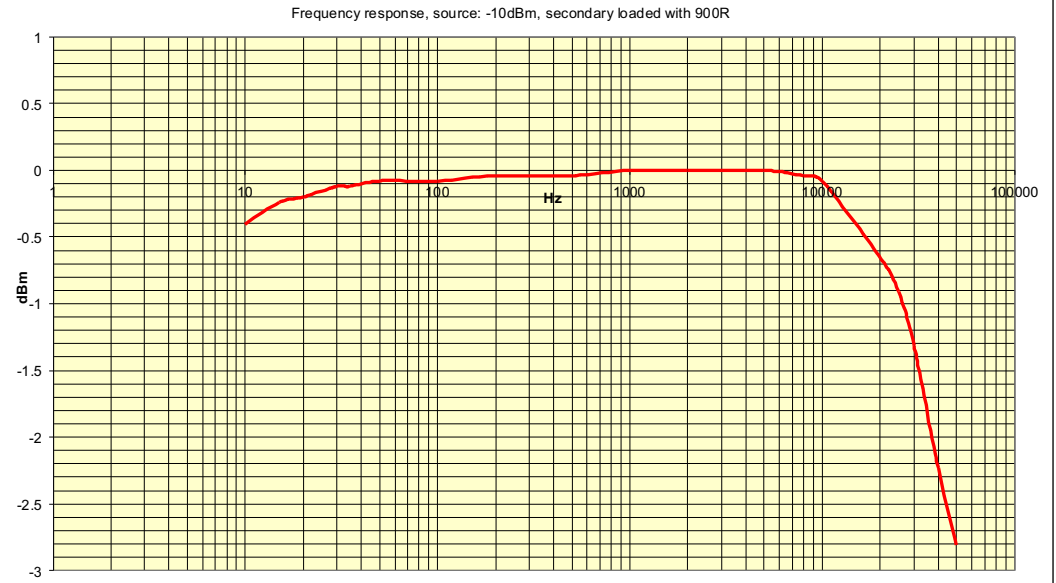

Unit 5, Oxonian Park, Langford Locks,
Kidlington, Oxfordshire. OX5 1FP
Tel: (01865) 855085 Fax: (01865) 855075
Website: www.oep.co.uk

DESCRIPTION	ISSUE	DATE	DRAWN	CHECKED	DRAWING NUMBER
1:1.22 C.T. 600 audio transformer with interwinding screen page 2 of 2	1	11/09/13	CS		Z1686E
	2	04/11/13	CS		
Scale: 2 to 1					
All dimensions in mm unless stated otherwise					