

MiniBridge

1.27 mm Connectors

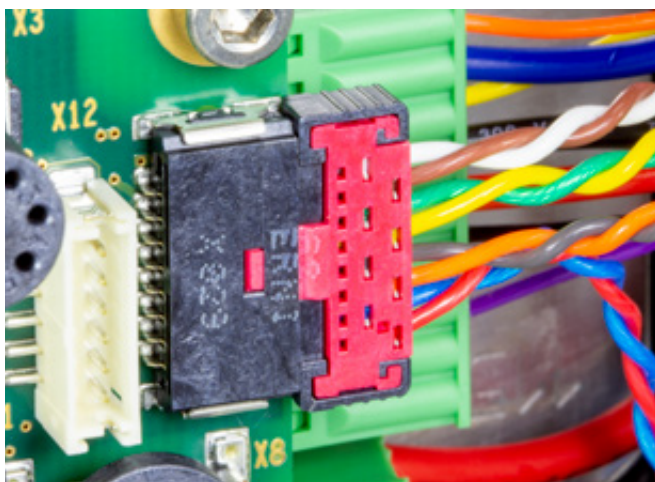

MiniBridge - CABLE CONNECTOR SYSTEMS

The compact design of the single-row cable connector systems in a 1.27 mm pitch is excellent for space-saving connections between PCBs and decentralised function units such as operator panel displays, switches, motors, fans or fuses. The single row MiniBridge connector Koshiri version with a 1.27 mm pitch offers a high level of mating reliability. The housing geometry helps to avoid damage of the male contacts even in case of improper skewed insertion. In addition to Koshiri Secure*, the MiniBridge connector fulfils the applicable requirements of LV214 for automotive connectors in Insulation Displacement Connection (IDC) technology. The cable connector system is used in various fields for example, automobile industry, mechanical engineering, medical technology and also consumer electronics. Various connection options can be realised thanks to the right angle or vertical male connectors and female connectors with 90° and 180° cable outlets. Both female and male connectors in Surface Mount Technology (SMT) and IDC variants are available. The plastic housing is resistant to temperatures up to 150 °C whereby the connector is suitable for lead-free reflow soldering. The male connectors are available as tape and reel packaging for automatic assembly.

The cable guide of the female connector simplifies cable connection or individual wires. Prefabricated cables are available in stock. Specified assemblies are realised within a short time period.



MiniBridge Connectors Standard



MiniBridge Connectors Koshiri

*Requirement for Koshiri Secure:

Signal and current carrying components (contacts) may only be touched by their signal and current carrying opposites (and their catch funnels) during assembly/disassembly. Contact with housing components is structurally not permitted. (Source LV 214)

TECHNICAL DETAILS

Standard Variant

Pitch	1.27 mm
Current rating per contact	up to 8 A (depends on cable)
Termination technology	Male connector SMT, female connector IDC
Cables	Ribbon cable AWG 26/7 Discrete wire AWG 22/7, AWG 24/7 and AWG 26/7
Variants	Vertical male connector type P, Right angle male connector type A, Right angle female connector type P, Female connector type A with 180° cable outlet, Female connector type P with 90° cable outlet, Male connector type P with 180° cable outlet
Interlocking	Female connector red (high vibration/shock load) - unlockable only with a tool, e.g. tip of pen Female connector black / white (normal vibration/shock load) - unlockable without any tool

Koshiri Variant

Pitch	1.27 mm
No. of Pins	2, 3, 4, 6, 8, 10, 12
Current rating per contact	up to 8,7 A (depends on cable)
Termination	Male connector SMT, female connector IDC
Cable	Discrete wire AWG 22/7, AWG 24/7 and AWG 26/7
Variants	Vertical male connector type P, Right angle male connector type A, Female connector type A with 180° cable outlet, Female connector type P with 90° cable outlet,
Interlocking	Female connector red (high vibration/shock load) - unlockable only with a tool, e.g. pen with a round tip



Mating Advantages Koshiri Variant

- Additional tongues at the male and grooves at the female connector allow a pre-alignment and provide an exact mating procedure.
- The male connector contact pins are not damaged during improper or skewed mating.

AVAILABLE TERMINATIONS

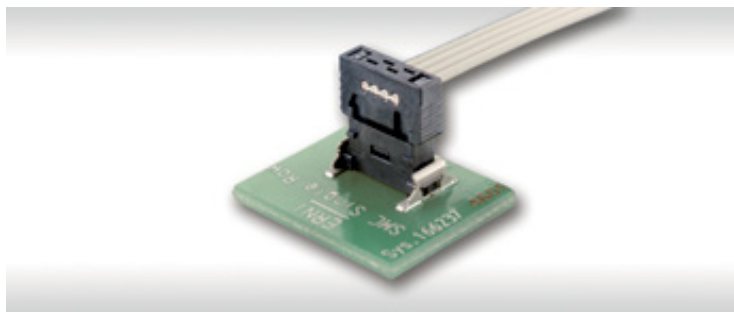

- Vertical male - Female with 90° cable outlet

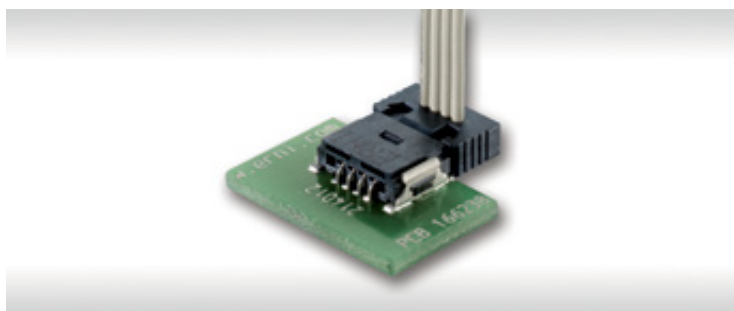

- Right angle male - Female with 90° cable outlet



- Right angle male - Female with 180° cable outlet

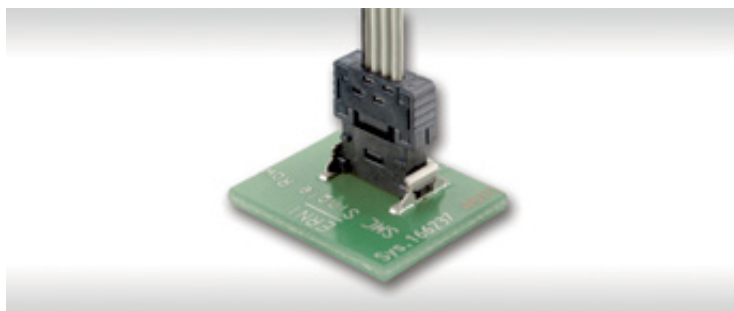

- Vertical male - Female with 180° cable outlet

AVAILABLE TERMINATIONS

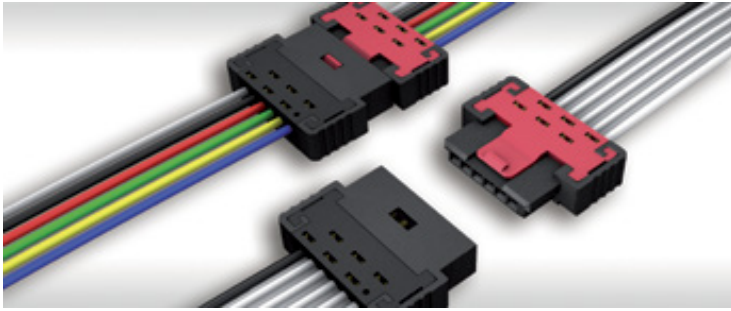

- Female and male with 180° cable outlet

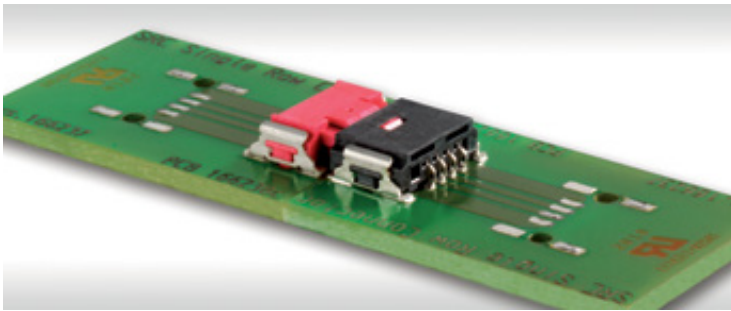

- Right angle male - Right angle female

FEATURES

Easy Assembly

- Pick-and-place cover for automatic assembly with a vacuum pipette.
- Reliable retention force due to ruggedized metal clips on both sides of each male.

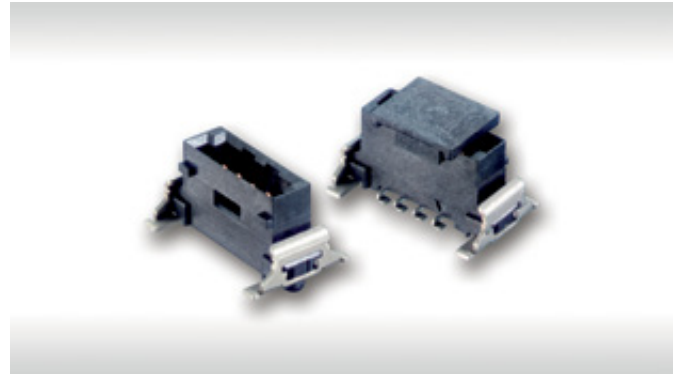

Guiding Elements

- The rugged insulation body of the male connector provides an excellent cable connector guide.
- Two pegs (round and oval) for exact positioning on the printed circuit board (pcb).



Interlocking

- Positive lock (red):
(high vibration/Shock load) unlockable only with a tool, e.g. tip of pen
- Friction lock (black):
(normal vibration/shock load) unlockable without any tool

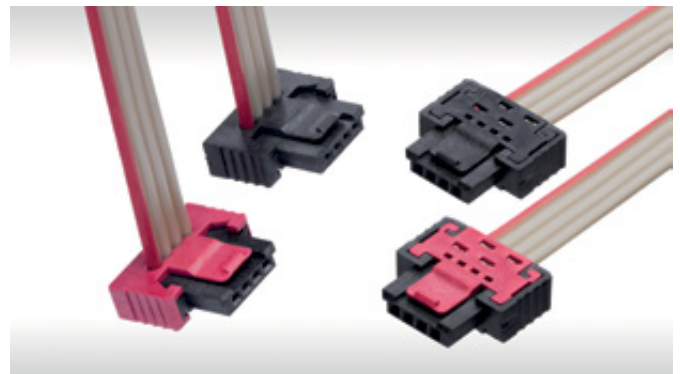

SSL-Lighting Technology

- Connectors with colourless insulation bodies helps prevent shadow formation in lighting applications, e.g. LED strips with transparent diffusion disks. Thus providing uniform light distribution.



MATING CONDITIONS

Allowed Angular Inclination Tolerances, Longitudinal 4.3°

Standard Variant

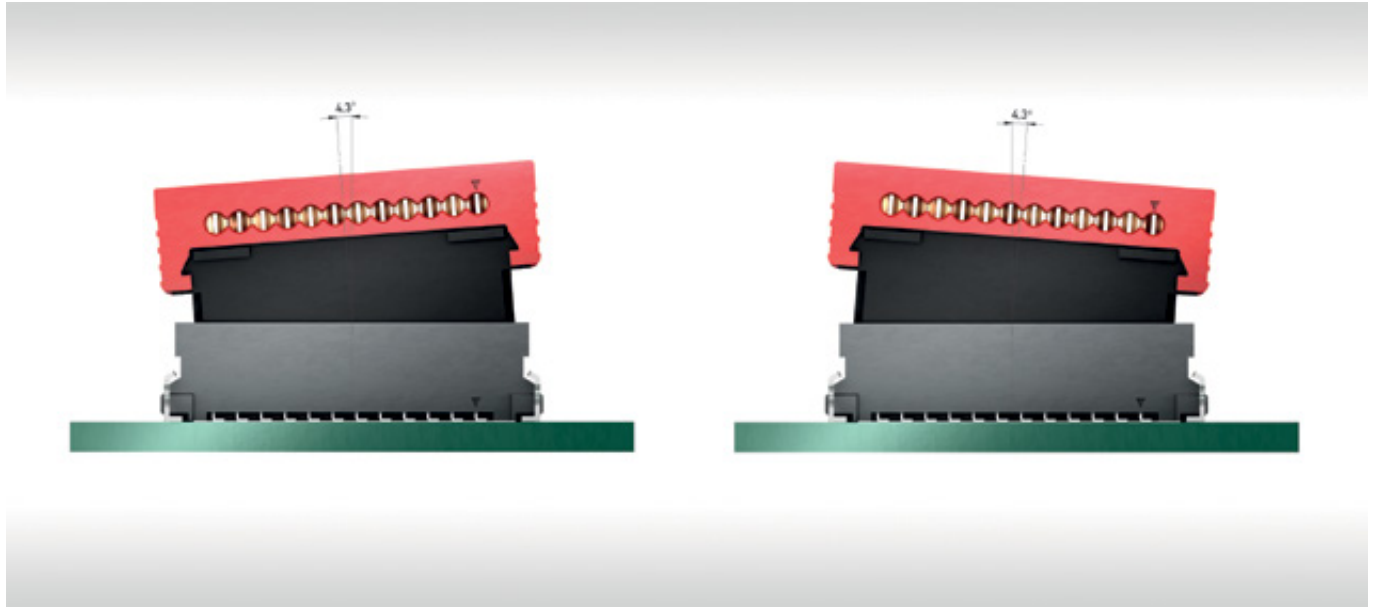

Allowed Angular Inclination Tolerances, Transverse 3.1°

Standard Variant

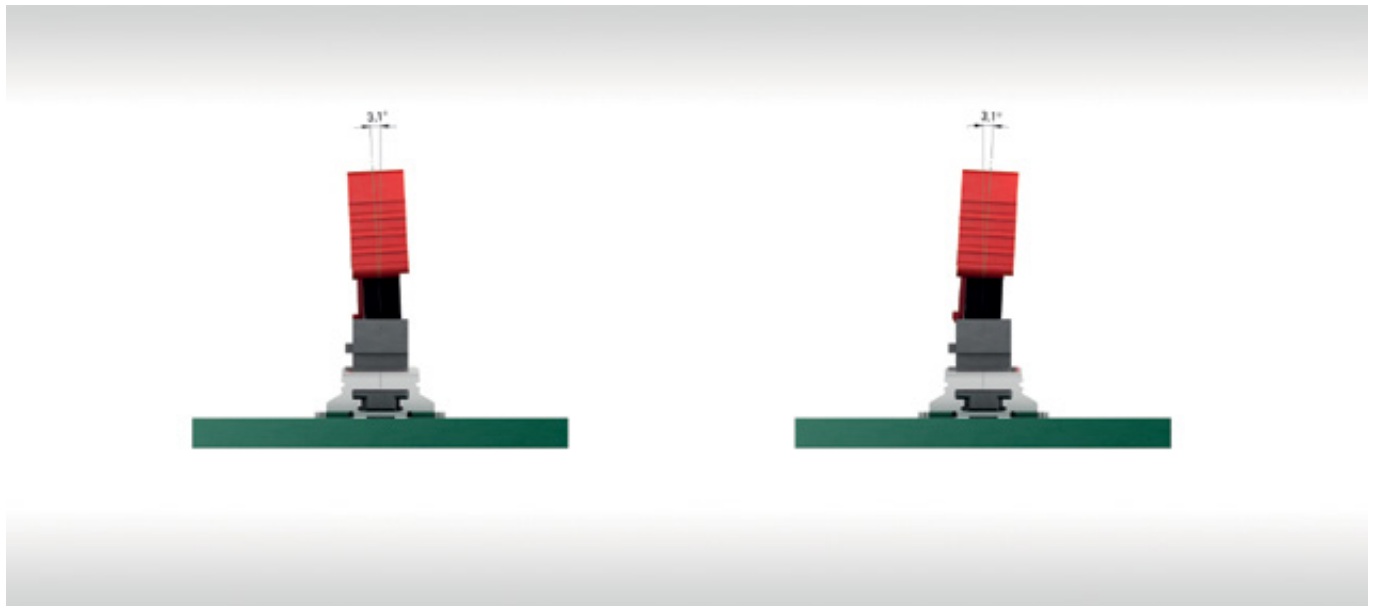

ELECTRICAL AND MECHANICAL CHARACTERISTICS SMT AND IDC

Technical Data

Description	Standard	Male Connector SMT Type A and P	Female Connector SMT Type P	Male Connector IDC Type P	Female Connector IDC Type A and P
Climate category	DIN EN 60068-1 test b	55 / 150 / 56	55 / 125 / 56	55 / 150 / 56	
Temperature range		-55 / 150 °C	-55 / 125 °C	-55 / 150 °C	
Current rating per contact	IEC60512 test 5b	see IDC or SMT female connector	20 C° max. 4.8 A 70 C° max. 3.2 A 100 C° max. 2.0 A	see IDC or SMT female connector	20 C° max. 8.7 A 70 C° max. 6.8 A 100 C° max. 5.4 A depends on cable
Air- and creepage distance		contact - contact 0.4 mm			
Operating voltage	IEC 60664	<p>The permissible operating voltages depend on the customer application and on the applicable or specified safety requirements.</p> <p>Insulation coordination according to IEC 60664-1 has to be regarded for the complete electrical device. Therefore, the maximum creepage and clearance distances of the mated connectors are specified for consideration as a part of the whole current path. In practice, reductions in creepage or clearance distances may occur due to the conductive pattern of the printed board or the wiring used, and have to be taken into account separately.</p> <p>As a result the creepage and clearance distances for the application may be reduced compared to those of the connector.</p>			
Dielectric strength	IEC 60512 test 4a	contact – contact 500 V _{rms}			
Contact resistance	IEC 60512 test 2a	≤ 25 mΩ			
Insulation resistance	IEC 60512 test 3a	≥ 10 ⁴ MΩ			
Vibration, sine	IEC 60512 test 6d	10 – 2000 Hz 20 g			
Contact disturbance (while vibration test)	IEC 60512 test 2e	< 1 μs			
Shock halfsine	IEC 60512 test 6c	50 g 11 ms			
Mechanical operation	IEC 60512 test 9a	500 mating cycles			
Insertion and withdrawal force	IEC 60512 test 13b	1 N per contact			
Gauge retention force	IEC 60512 test 16e	> 0.1 N			
Polarization	IEC 60512-13-5	60 N			
Interlocking noise				40 dB (A)	

ELECTRICAL AND MECHANICAL CHARACTERISTICS SMT AND IDC

Technical Data

Description	Standard	Male Connector SMT Type A and P	Female Connector SMT Type P	Male Connector IDC Type P	Female Connector IDC Type A and P
Process-conditions					
Solder temperature max.	IEC 60068-2-20				
Hand soldering temperature max.		3.5 s at 350 °C			
Reflow soldering temperature max.	JEDEC J-STD-020	20 - 40 s at 260 °C			
Coplanarity		< 0.1 mm			
Housing Material					
Plastic material		LCP			
CTI value	IEC 112	175			
UL flame rating		UL 94 V-0*			
UL file		E83005			
Contact Material					
Base material		Cu alloy			
Mating area		gold plating			
Termination area		Sn			
Environment compatibility					
Recycling		no flame-retardant additives, no toxic additives allow easy recycling			
Product-approval					
UL		E84703			

* not valid for SMT female connectors in red color (positive lock)

ELECTRICAL AND MECHANICAL CHARACTERISTICS CABLE

Cable Data

Description	Standard Cable (PVC)	High Temperature Cable (TPE-ET)	Halogen-free Cable (TPE-O)
Cross Section	AWG-26/ 7/ 0.14 mm ²		
Conductor	Cu wire tin-plated		
Marking	available		
Insulation	PVC wall thickness min. 0.178 mm	TPE-ET wall thickness min. 0.2 mm	Polyolefin wall thickness min. 0.178 mm
Shore hardness	94 ±3 (Shore A)	96 ±3 (Shore A)	90 ±3 (Shore A)
Technical data			
Temperature range	-30/105 °C (unmoved) -20/105 °C (moved)	-60/125 °C (unmoved) -40/125 °C (moved)	-40/105 °C (unmoved) -20/105 °C (moved)
Voltage rating	max. 300 V		
Dielectric strength	2000 V _{rms}	1500 V _{rms}	1500 V _{rms}
Conductor resistance	≤ 135 Ω/km	≤ 138 Ω/km at 20 °C	max. 135 Ω/km at 20 °C
Insulation resistance	≥ 100 MΩ x km at 20 °C	≥ 20 MΩ x km at 20 °C	min. 20 MΩ x km at 20 °C
Capacitance at 1 kHz	GSG ≤ 60 pF/m	GSG 40 pF/m	GSG 40 pF/m
Inductance	GSG 0.9 μH/m at 10 KHz	GSG 0.79 μH/m at 10 KHz	GSG 0.95 μH/m at 1 KHz
Impedance	GSG 100 Ω	GSG 110 Ω	GSG 95 Ω
Crosstalk in %	Cable length 3 m: NE 5.4 / FE 6.8	-	-
Propagation delay	4.6 ns/m	6.2 ns/m	-
Flammability	UL VW-1; CSA FT-1	UL 1581 Sec. 1080, VW-1	UL 1581
Product-approval			
UL	AWM 2651	- *	AWM 21151
CSA	Yes	No	Yes

* UL Style 21739 on request

For more information on tooling, variation and processing of cable please check [Processing Specification MiniBridge IDC](#)

RIGHT ANGLE MALE SMT TYPE A

Product Specification

- SMT termination
- tape and reel packaging for automatic assembly
- suitable for lead-free reflow soldering process
- white versions for lighting applications
- for available part numbers please refer to our website



Dimensional Drawings

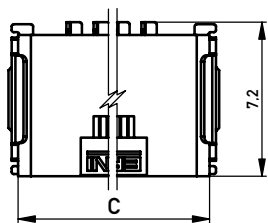
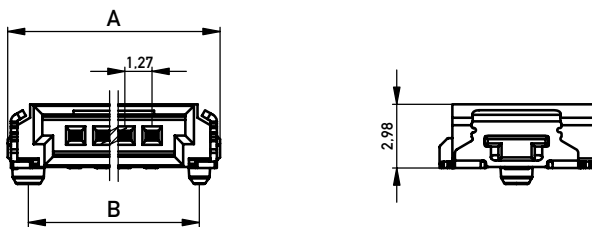

Recommended Layout

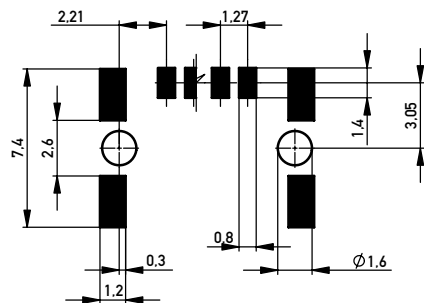

No. of Contacts	A	B	C
2	7.62	5.69	6.72
3	8.89	6.96	7.99
4	10.16	8.23	9.26
6	12.70	10.77	11.80
8	15.24	13.31	14.34
10	17.78	15.85	16.88
12	20.32	18.39	19.42

All dimensions in mm

VERTICAL MALE SMT TYPE P

Product Specification

- SMT termination
- tape and reel packaging for automatic assembly
- suitable for lead-free reflow soldering process
- with pick-and-place cover
- for available part numbers please refer to our website



Dimensional Drawings

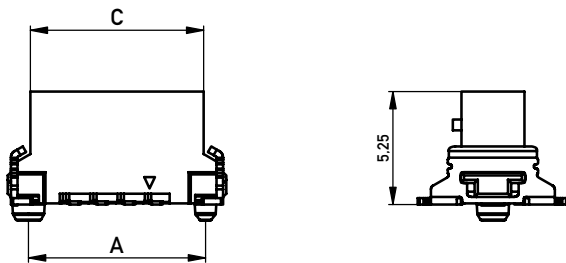

No. of Contacts	A	B	C
2	5.69	7.62	5.60
3	6.96	8.89	6.79
4	8.23	10.16	8.06
6	10.77	12.70	10.60
8	13.31	15.24	13.14
10	15.85	17.78	15.68
12	18.39	20.32	18.22

All dimensions in mm

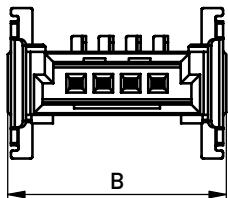

Recommended Layout

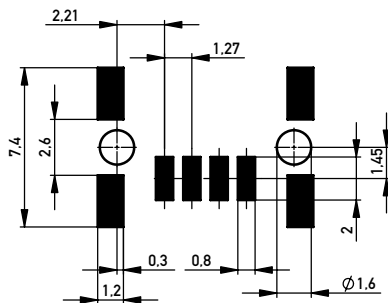

RIGHT ANGLE FEMALE SMT TYPE P

Product Specification

- SMT termination
- tape and reel packaging for automatic assembly
- suitable for lead-free reflow soldering process
- white versions for lighting applications
- two types of interlocking are available
- for available part numbers please refer to our website

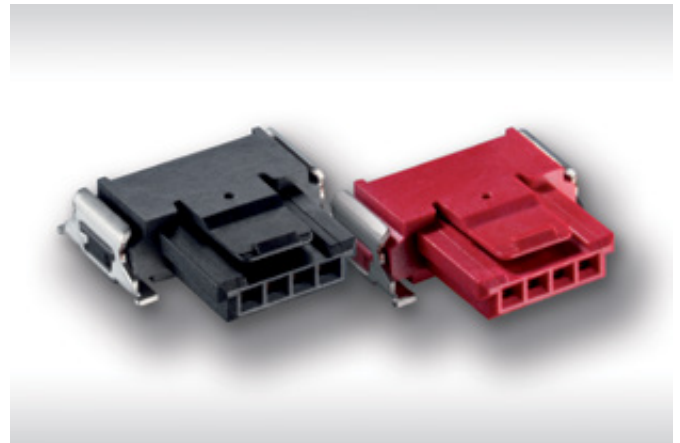

Dimensional Drawings

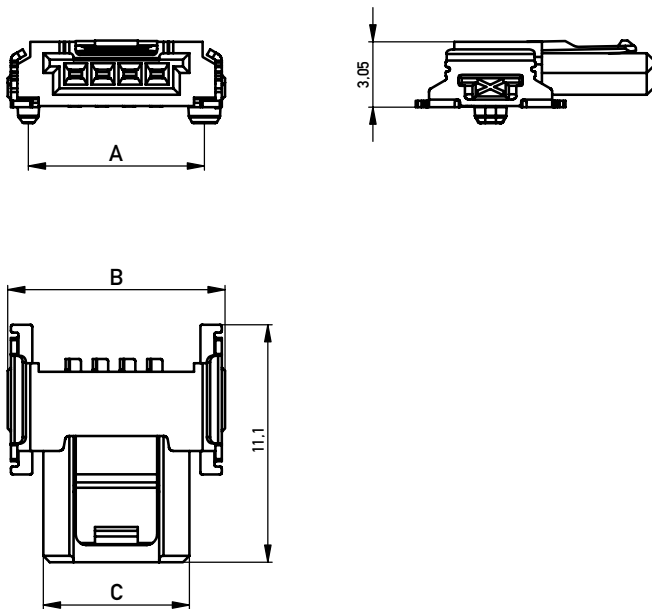

No. of Contacts	A	B	C
2	5.69	7.62	4.29
3	6.96	8.89	5.56
4	8.23	10.16	6.83
6	10.77	12.70	9.37
8	13.31	15.24	11.91

All dimensions in mm

Recommended Layout

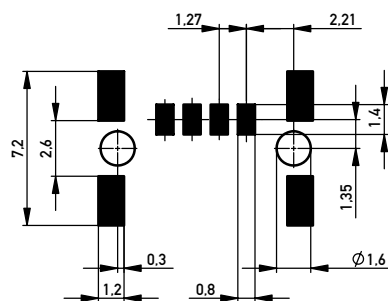

CABLE ASSEMBLIES

Product Specification

- IDC termination
- Ribbon cable AWG 26/7
- Discrete wire AWG 22/7, AWG 24/7 and AWG 26/7
- for available part numbers please refer to our website

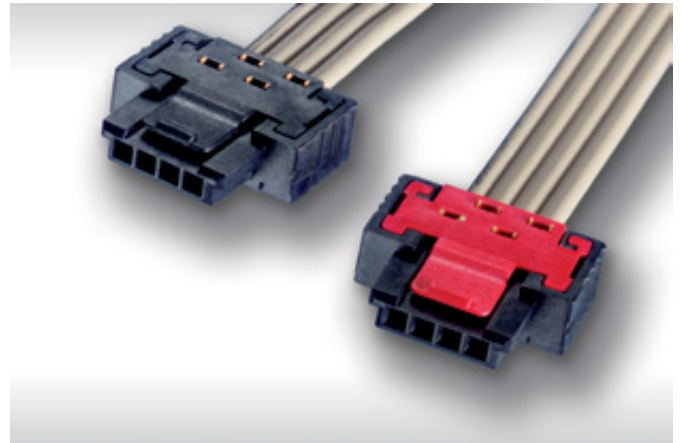

Dimensional Drawings

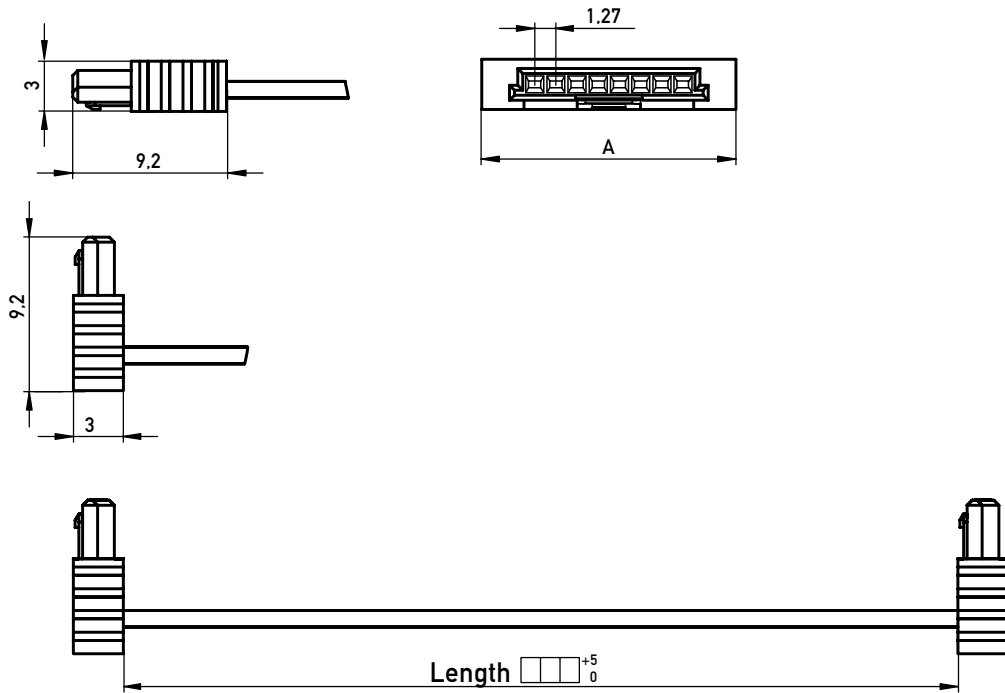

No. of Contacts	A
2	7.62
3	8.89
4	10.16
6	12.70
8	15.24
10	17.78
12	20.32

All dimensions in mm

CABLE ASSEMBLIES

Coding and Interlocking

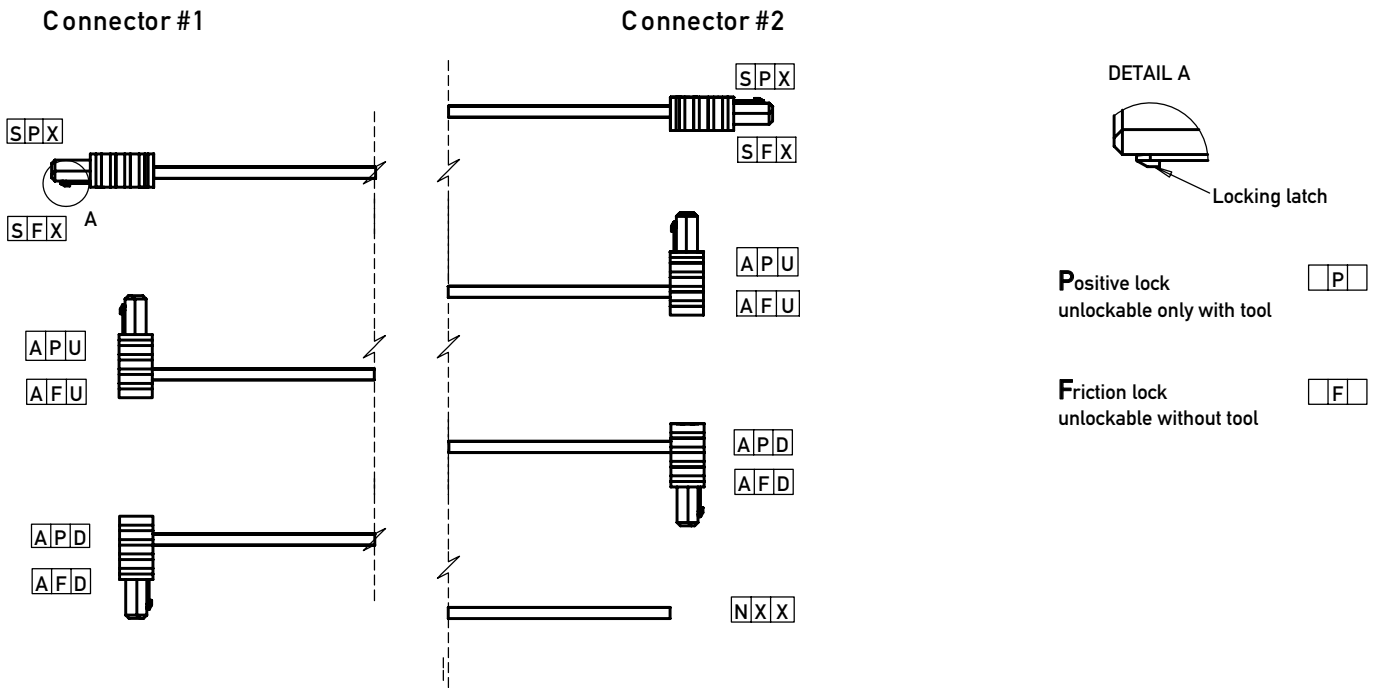

Order Code Standard Assemblies

IDCCS _ SRC _ 1.27 _ □□ _ □□ _ □□□ _ □□□□□ _ □□

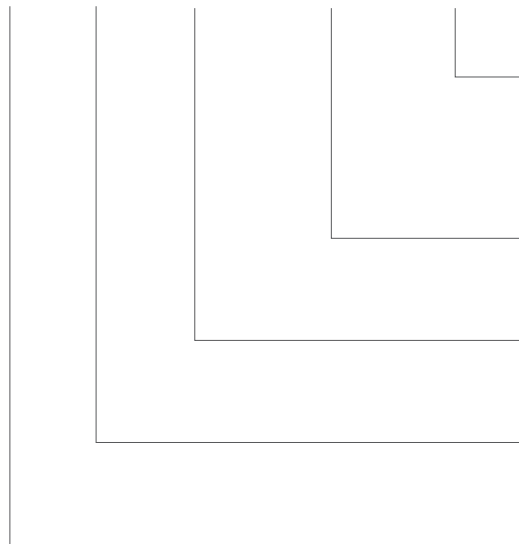

Cable Type

high temperature AWG 26/7
PVC AWG 26/7
halogen-free AWG 26/7

Length

25 to 995 mm in 5 mm increments

Connector #2

Connector #1

No. of Pins

2-digit: 02, 03, 04, 06, 08, 10, 12

Discrete wire cable assemblies on request.

CABLE ASSEMBLIES

Ordering Information Standard Cable Assemblies

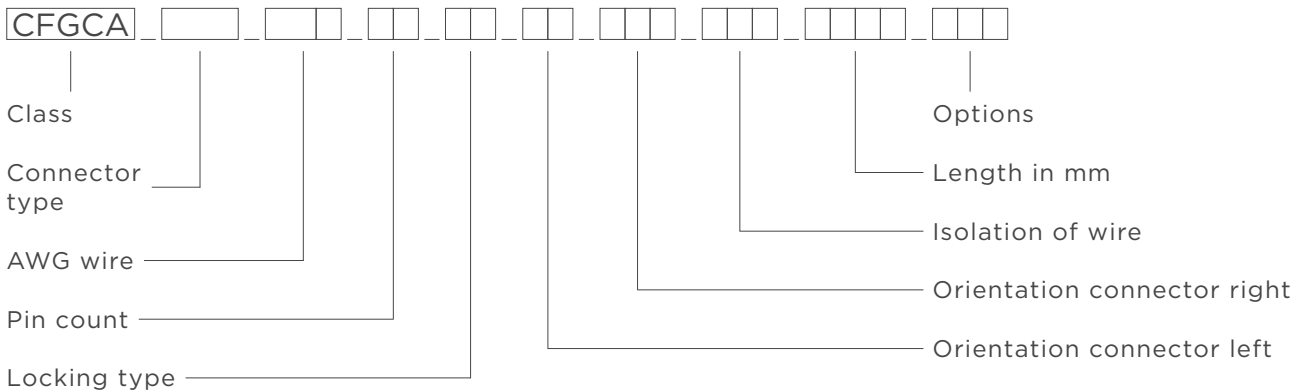

Example for a standard configuration:

CFGCA SRC 26R 04 PL ST STI PVC 0175 APR

Ordering code field	Number of digits	Example configuration	Composition of the configuration
Class	5	CFGCA	ConFiGurable Cable Assembly
Connector type	3	SRC	SRC
AWG wire	3	26R	1st and 2nd column: 26 3rd column: Ribbon Cable
Pin count	2	04	12, 16, 20, 26, 32, 40, 50, 68, 80
Locking type	2	PL	KoS hiri P ositive L ock F riction L ock
Orientation connector left	2	ST	S Traight A ngeled U p A ngeled D own
Orientation connector right	3	STI	1st and 2nd column: S Traight A ngeled U p A ngeled D own N ot C onne C t E d 3rd column: I -connected (1:1) X -connected (1:N)
Isolation of wire	2 - 4	PVC	PVC : -10 °C to +105 °C TPE : -40 °C to +125 °C PO : -20 °C to +105 °C, halogen free
Length in mm	4	0175	175 mm / 25 - 2500 mm possible
Options	3	APR	1st column: A symmetric S ymmetric 2nd and 3rd column: custom P Rint U L Label P rint ad U L Label N o print N o UL label

Connect With Us

We make it easy to connect with our experts and are ready to provide all the support you need. Visit www.te.com/support to chat with a Product Information Specialist.

te.com

2023 TE Connectivity. All Rights Reserved.

TE Connectivity, TE connectivity (logo), ERNI, MiniBridge and Every Connection Counts are trademarks owned or licensed by the TE Connectivity family of companies. All other logos, products and/or company names referred to herein might be trademarks of their respective owners.

The information given herein, including drawings, illustrations and schematics which are intended for illustration purposes only, is believed to be reliable. However, TE Connectivity makes no warranties as to its accuracy or completeness and disclaims any liability in connection with its use. TE Connectivity's obligations shall only be as set forth in TE Connectivity's Standard Terms and Conditions of Sale for this product and in no case will TE Connectivity be liable for any incidental, indirect or consequential damages arising out of the sale, resale, use or misuse of the product. Users of TE Connectivity products should make their own evaluation to determine the suitability of each such product for the specific application.

JS 10/23 Original

CATALOG

TE Connectivity

ERNI Deutschland GmbH
a TE Connectivity Ltd. company
Seestraße 9
73099 Adelberg
Germany

Tel +49 7166 50-0
www.te.com