

# NC7WZ16

## TinyLogic UHS Dual Buffer

### Description

The NC7WZ16 is a dual buffer from ON Semiconductor's Ultra-High Speed Series of TinyLogic. The device is fabricated with advanced CMOS technology to achieve ultra-high speed with high output drive while maintaining low static power dissipation over a very broad  $V_{CC}$  operating range. The device is specified to operate over the 1.65 V to 5.5 V  $V_{CC}$  range. The inputs and outputs are high impedance when  $V_{CC}$  is 0 V. Inputs tolerate voltages up to 5.5 V independent of  $V_{CC}$  operating voltage.

### Features

- Ultra-High Speed:  $t_{PD}$  2.4 ns (Typical) into 50 pF at 5 V  $V_{CC}$
- High Output Drive:  $\pm 24$  mA at 3 V  $V_{CC}$
- Broad  $V_{CC}$  Operating Range: 1.65 V to 5.5 V
- Matches Performance of LCX when Operated at 3.3 V  $V_{CC}$
- Power Down High-Impedance Inputs / Outputs
- Over-Voltage Tolerance Inputs Facilitate 5 V to 3 V Translation
- Proprietary Noise / EMI Reduction Circuitry
- Ultra-Small MicroPak™ Packages
- Space-Saving SC70 Package
- These Devices are Pb-Free, Halogen Free/BFR Free and are RoHS Compliant

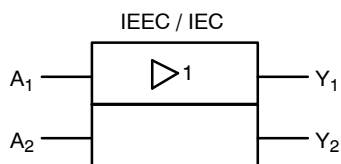

Figure 1. Logic Symbol



ON Semiconductor®

[www.onsemi.com](http://www.onsemi.com)

### MARKING DIAGRAMS

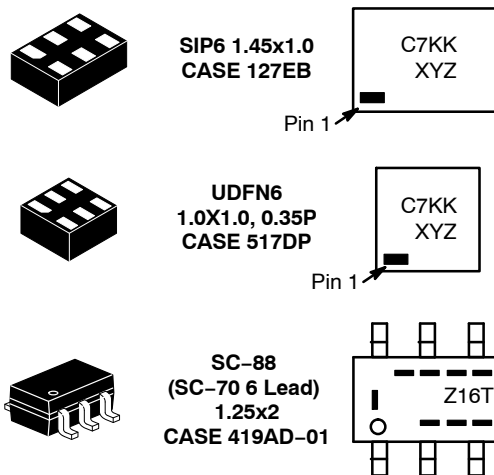

- C7, Z16 = Specific Device Code
- KK = 2-Digit Lot Run Traceability Code
- XY = 2-Digit Date Code Format
- Z = Assembly Plant Code
- = Year Coding Scheme
- |- - = Plant Code Identifier
- T = Die Run Code
- = Eight-Week Datacoding Scheme

### ORDERING INFORMATION

See detailed ordering, marking and shipping information in the package dimensions section on page 6 of this data sheet.

# NC7WZ16

## Pin Configurations

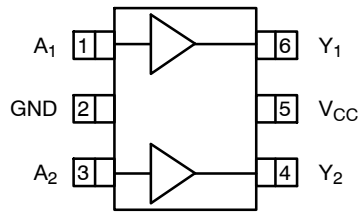

Figure 2. SC70 (Top View)

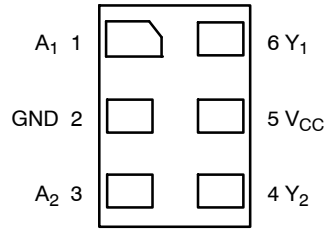

Figure 3. MicroPak (Top Through View)



NOTES:

1. AAA represents product code top mark (see ordering table).
2. Orientation of Top Mark determines Pin One location. Read the top product code mark left to right, Pin One is the lower left pin.

Figure 4. Pin 1 Orientation

### PIN DEFINITIONS

| Pin # SC70 | Pin # MicroPak | Name            | Description    |
|------------|----------------|-----------------|----------------|
| 1          | 1              | A <sub>1</sub>  | Input          |
| 2          | 2              | GND             | Ground         |
| 3          | 3              | A <sub>2</sub>  | Input          |
| 4          | 4              | Y <sub>2</sub>  | Output         |
| 5          | 5              | V <sub>CC</sub> | Supply Voltage |
| 6          | 6              | Y <sub>1</sub>  | Output         |

### FUNCTION TABLE (Y = A)

| Inputs   | Output   |
|----------|----------|
| <b>A</b> | <b>Y</b> |
| L        | L        |
| H        | H        |

H = HIGH Logic Level  
L LOW Logic Level

# NC7WZ16

## ABSOLUTE MAXIMUM RATINGS

| Symbol                              | Parameter   |                        | Min  | Max  | Unit |
|-------------------------------------|---|------------------------|------|------|------|
| V <sub>CC</sub>                     | Supply Voltage                                    |                        | -0.5 | 6.5  | V    |
| V <sub>IN</sub>                     | DC Input Voltage                                  |                        | -0.5 | 6.5  | V    |
| V <sub>OUT</sub>                    | DC Output Voltage                                 |                        | -0.5 | 6.5  | V    |
| I <sub>IK</sub>                     | DC Input Diode Current                            | V <sub>IN</sub> < 0 V  | -    | -50  | mA   |
| I <sub>OK</sub>                     | DC Output Diode Current                           | V <sub>OUT</sub> < 0 V | -    | -50  | mA   |
| I <sub>OUT</sub>                    | DC Output Source / Sink Current                   |                        | -    | ±50  | mA   |
| I <sub>CC</sub> or I <sub>GND</sub> | DC V <sub>CC</sub> or Ground Current              |                        | -    | ±100 | mA   |
| T <sub>STG</sub>                    | Storage Temperature Range                         |                        | -65  | +150 | °C   |
| T <sub>J</sub>                      | Junction Temperature Under Bias                   |                        | -    | +150 | °C   |
| T <sub>L</sub>                      | Junction Lead Temperature (Soldering, 10 Seconds) |                        | -    | +260 | °C   |
| P <sub>D</sub>                      | Power Dissipation at +85°C                        | SC70-6                 | -    | 190  | mW   |
|                                     |   | MicroPak-6             | -    | 327  |      |
|                                     |   | MicroPak2™-6           | -    | 327  |      |
| ESD                                 | Human Body Model, JEDEC: JESD22-A114              |                        | -    | 4000 | V    |
|                                     | Charge Device Model, JEDEC: JESD22-C101           |                        | -    | 2000 |      |

Stresses exceeding those listed in the Maximum Ratings table may damage the device. If any of these limits are exceeded, device functionality should not be assumed, damage may occur and reliability may be affected.

## RECOMMENDED OPERATING CONDITIONS

| Symbol                          | Parameter                     | Conditions                            | Min  | Max             | Unit |
|---------------------------------|-------------------------------|---------------------------------------|------|-----------------|------|
| V <sub>CC</sub>                 | Supply Voltage Operating      |                                       | 1.65 | 5.50            | V    |
|                                 | Supply Voltage Data Retention |                                       | 1.50 | 5.50            |      |
| V <sub>IN</sub>                 | Input Voltage                 |                                       | 0    | 5.5             | V    |
| V <sub>OUT</sub>                | Output Voltage                |                                       | 0    | V <sub>CC</sub> | V    |
| t <sub>r</sub> , t <sub>f</sub> | Input Rise and Fall Times     | V <sub>CC</sub> = 1.8 V, 2.5 V ±0.2 V | 0    | 20              | ns/V |
|                                 |                               | V <sub>CC</sub> = 3.3 V ±0.3 V        | 0    | 10              |      |
|                                 |                               | V <sub>CC</sub> = 5.5 V ±0.5 V        | 0    | 5               |      |
| T <sub>A</sub>                  | Operating Temperature         |                                       | -40  | +125            | °C   |
| θ <sub>JA</sub>                 | Thermal Resistance            | SC70-6                                | -    | 659             | °C/W |
|                                 |                               | MicroPak                              | -    | 382             |      |
|                                 |                               | MicroPak2                             | -    | 382             | °C/W |

Functional operation above the stresses listed in the Recommended Operating Ranges is not implied. Extended exposure to stresses beyond the Recommended Operating Ranges limits may affect device reliability.

3. Unused inputs must be held HIGH or LOW. They may not float.

# NC7WZ16

## DC ELECTRICAL CHARACTERISTICS

| Symbol           | Parameter                        | V <sub>CC</sub> (V) | Conditions                        |   | T <sub>A</sub> = 25°C |      |                      | T <sub>A</sub> = -40 to 85°C |                      | Unit |
|------------------|----------------------------------|---------------------|-----------------------------------|---|-----------------------|------|----------------------|------------------------------|----------------------|------|
|                  |                                  |                     |                                   |   | Min                   | Typ  | Max                  | Min                          | Max                  |      |
| V <sub>IH</sub>  | HIGH Level Control Input Voltage | 1.65 to 1.95        |                                   |   | 0.65 V <sub>CC</sub>  | -    | -                    | 0.65 V <sub>CC</sub>         | -                    | V    |
|                  |                                  | 2.3 to 5.5          |                                   |   | 0.70 V <sub>CC</sub>  | -    | -                    | 0.70 V <sub>CC</sub>         | -                    |      |
| V <sub>IL</sub>  | LOW Level Control Input Voltage  | 1.65 to 1.95        |                                   |   | -                     | -    | 0.35 V <sub>CC</sub> | -                            | 0.35 V <sub>CC</sub> | V    |
|                  |                                  | 2.3 to 5.5          |                                   |   | -                     | -    | 0.30 V <sub>CC</sub> | -                            | 0.30 V <sub>CC</sub> |      |
| V <sub>OH</sub>  | HIGH Level Output Voltage        | 1.65                | V <sub>IN</sub> = V <sub>IH</sub> | I <sub>OH</sub> = -100 μA                   | 1.55                  | 1.65 | -                    | 1.55                         | -                    | V    |
|                  |                                  | 1.80                |                                   |   | 1.70                  | 1.80 | -                    | 1.70                         | -                    |      |
|                  |                                  | 2.30                |                                   |   | 2.20                  | 2.30 | -                    | 2.20                         | -                    |      |
|                  |                                  | 3.00                |                                   |   | 2.90                  | 3.00 | -                    | 2.90                         | -                    |      |
|                  |                                  | 4.50                |                                   |   | 4.40                  | 4.50 | -                    | 4.40                         | -                    |      |
|                  |                                  | 1.65                |                                   | I <sub>OH</sub> = -4 mA                     | 1.29                  | 1.52 | -                    | 1.21                         | -                    |      |
|                  |                                  | 2.30                |                                   | I <sub>OH</sub> = -8 mA                     | 1.90                  | 2.14 | -                    | 1.90                         | -                    |      |
|                  |                                  | 3.00                |                                   | I <sub>OH</sub> = -16 mA                    | 2.40                  | 2.75 | -                    | 2.40                         | -                    |      |
|                  |                                  | 3.00                |                                   | I <sub>OH</sub> = -24 mA                    | 2.30                  | 2.62 | -                    | 2.30                         | -                    |      |
|                  |                                  | 4.50                |                                   | I <sub>OH</sub> = -32 mA                    | 3.80                  | 4.13 | -                    | 3.80                         | -                    |      |
| V <sub>OL</sub>  | LOW Level Output Voltage         | 1.65                | V <sub>IN</sub> = V <sub>IL</sub> | I <sub>OL</sub> = 100 μA                    | -                     | 0.00 | 0.10                 | -                            | 0.10                 | V    |
|                  |                                  | 1.80                |                                   |   | -                     | 0.00 | 0.10                 | -                            | 0.10                 |      |
|                  |                                  | 2.30                |                                   |   | -                     | 0.00 | 0.10                 | -                            | 0.10                 |      |
|                  |                                  | 3.00                |                                   |   | -                     | 0.00 | 0.10                 | -                            | 0.10                 |      |
|                  |                                  | 4.50                |                                   |   | -                     | 0.00 | 0.10                 | -                            | 0.10                 |      |
|                  |                                  | 1.65                |                                   | I <sub>OL</sub> = 4 mA                      | -                     | 0.08 | 0.24                 | -                            | 0.24                 |      |
|                  |                                  | 2.30                |                                   | I <sub>OL</sub> = 8 mA                      | -                     | 0.10 | 0.30                 | -                            | 0.30                 |      |
|                  |                                  | 3.00                |                                   | I <sub>OL</sub> = 16 mA                     | -                     | 0.16 | 0.40                 | -                            | 0.40                 |      |
|                  |                                  | 3.00                |                                   | I <sub>OL</sub> = 24 mA                     | -                     | 0.24 | 0.55                 | -                            | 0.55                 |      |
|                  |                                  | 4.50                |                                   | I <sub>OL</sub> = 32 mA                     | -                     | 0.25 | 0.55                 | -                            | 0.55                 |      |
| I <sub>IN</sub>  | Input Leakage Current            | 1.65 to 5.5         |                                   | 0 ≥ V <sub>IN</sub> ≥ 5.5 V                 | -                     | -    | ±0.1                 | -                            | ±1.0                 | μA   |
| I <sub>OFF</sub> | Power Off Leakage Current        | 0                   |                                   | V <sub>IN</sub> or V <sub>OUT</sub> = 5.5 V | -                     | -    | 1.0                  | -                            | 10                   | μA   |
| I <sub>CC</sub>  | Quiescent Supply Current         | 1.65 to 5.50        |                                   | V <sub>IN</sub> = 5.5 V, GND                | -                     | -    | 1.0                  | -                            | 10                   | μA   |

AC ELECTRICAL CHARACTERISTICS

| Symbol                              | Parameter  | V <sub>CC</sub> (V) | Conditions                                       | T <sub>A</sub> = 25°C                             |     |     | T <sub>A</sub> = -40 to 85°C |      | Unit |
|-------------------------------------|--|---------------------|--|---|-----|-----|------------------------------|------|------|
|                                     |  |                     |  | Min   | Typ | Max | Min                          | Max  |      |
| t <sub>PLH</sub> , t <sub>PHL</sub> | Propagation Delay<br>(Figure 5, 6)                   | 1.65                | C <sub>L</sub> = 15 pF,<br>R <sub>L</sub> = 1 MΩ | -   | 5.5 | 9.6 | -                            | 10.6 | ns   |
|                                     |  | 1.80                |  | -   | 4.6 | 8.0 | -                            | 8.8  |      |
|                                     |  | 2.50 ±0.20          |  | -   | 3.0 | 5.2 | -                            | 5.8  |      |
|                                     |  | 3.30 ±0.30          |  | -   | 2.3 | 3.6 | -                            | 4.0  |      |
|                                     |  | 5.00 ±0.50          |  | -   | 1.8 | 2.9 | -                            | 3.2  |      |
|                                     |  | 3.30 ±0.30          |  | C <sub>L</sub> = 50 pF,<br>R <sub>L</sub> = 500 Ω | -   | 3.0 | 4.6                          | -    |      |
|                                     |  | 5.00 ±0.50          | -  |   | 2.4 | 3.8 | -                            | 4.2  |      |
| C <sub>IN</sub>                     | Input Capacitance                                    | 0                   |  | -   | 2.5 | -   | -                            | -    | pF   |
| C <sub>PD</sub>                     | Power Dissipation Capacitance<br>(Note 4) (Figure 7) | 3.30                |  | -   | 10  | -   | -                            | -    | pF   |
|                                     |  | 5.00                |  | -   | 12  | -   | -                            | -    |      |

4. C<sub>PD</sub> is defined as the value of the internal equivalent capacitance which is derived from dynamic operating current consumption (I<sub>CCD</sub>) at no output loading and operating at 50% duty cycle. C<sub>PD</sub> is related to I<sub>CCD</sub> dynamic operating current by the expression:  
 $I_{CCD} = (C_{PD}) (V_{CC}) (f_{IN}) + (I_{CCstatic})$ .

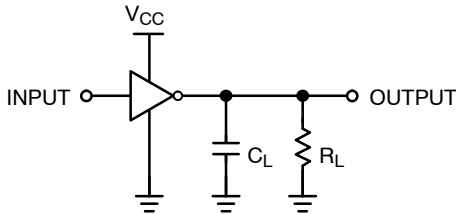

NOTE:

5. C<sub>L</sub> includes load and stray capacitance; inputs PRR = 1.0 MHz, t<sub>W</sub> = 500 ns.

Figure 5. AC Test Circuit

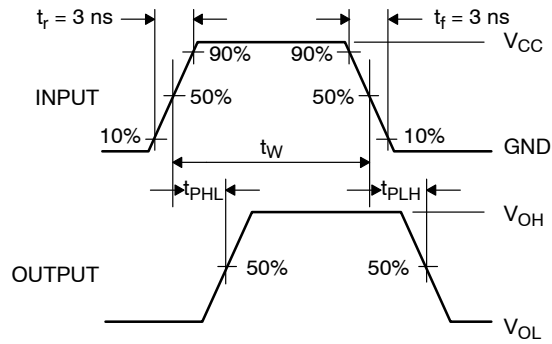
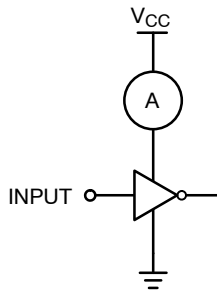

Figure 6. AC Waveforms



NOTE:

6. Input = AC Waveform; t<sub>r</sub> = t<sub>f</sub> = 1.8 ns; PRR = 10 MHz; Duty Cycle = 50%.

Figure 7. I<sub>CCD</sub> Test Circuit

# NC7WZ16

## DEVICE ORDERING INFORMATION

| Device     | Top Mark | Packages                                     | Shipping <sup>†</sup> |
|------------|----------|--|-----------------------|
| NC7WZ16P6X | Z16      | 6-Lead SC70, EIAJ SC-88a, 1.25 mm Wide       | 3000 / Tape & Reel    |
| NC7WZ16L6X | C7       | 6-Lead MicroPak, 1.00 mm Wide                | 5000 / Tape & Reel    |
| NC7WZ16FHX | C7       | 6-Lead, MicroPak2, 1x1 mm Body, .35 mm Pitch | 5000 / Tape & Reel    |

<sup>†</sup>For information on tape and reel specifications, including part orientation and tape sizes, please refer to our Tape and Reel Packaging Specifications Brochure, BRD8011/D.

MicroPak and MicroPak2 are trademarks of Semiconductor Components Industries, LLC (SCILLC) or its subsidiaries in the United States and/or other countries.

# MECHANICAL CASE OUTLINE

## PACKAGE DIMENSIONS

ON Semiconductor®



SIP6 1.45X1.0  
CASE 127EB  
ISSUE O

DATE 31 AUG 2016



NOTES:

1. CONFORMS TO JEDEC STANDARD MO-252 VARIATION UAAD
2. DIMENSIONS ARE IN MILLIMETERS
3. DRAWING CONFORMS TO ASME Y14.5M-2009
4. PIN ONE IDENTIFIER IS 2X LENGTH OF ANY OTHER LINE IN THE MARK CODE LAYOUT.

|                         |                      |  |
|-------------------------|----------------------|--|
| <b>DOCUMENT NUMBER:</b> | <b>98AON13590G</b>   | Electronic versions are uncontrolled except when accessed directly from the Document Repository. Printed versions are uncontrolled except when stamped "CONTROLLED COPY" in red. |
| <b>DESCRIPTION:</b>     | <b>SIP6 1.45X1.0</b> | <b>PAGE 1 OF 1</b>   |

ON Semiconductor and are trademarks of Semiconductor Components Industries, LLC dba ON Semiconductor or its subsidiaries in the United States and/or other countries. ON Semiconductor reserves the right to make changes without further notice to any products herein. ON Semiconductor makes no warranty, representation or guarantee regarding the suitability of its products for any particular purpose, nor does ON Semiconductor assume any liability arising out of the application or use of any product or circuit, and specifically disclaims any and all liability, including without limitation special, consequential or incidental damages. ON Semiconductor does not convey any license under its patent rights nor the rights of others.

# MECHANICAL CASE OUTLINE

## PACKAGE DIMENSIONS

ON Semiconductor®



SC-88 (SC-70 6 Lead), 1.25x2  
CASE 419AD-01  
ISSUE A

DATE 07 JUL 2010

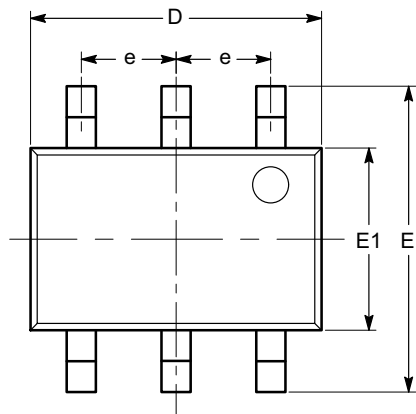

TOP VIEW

| SYMBOL     | MIN      | NOM  | MAX  |
|------------|----------|------|------|
| A          | 0.80     |      | 1.10 |
| A1         | 0.00     |      | 0.10 |
| A2         | 0.80     |      | 1.00 |
| b          | 0.15     |      | 0.30 |
| c          | 0.10     |      | 0.18 |
| D          | 1.80     | 2.00 | 2.20 |
| E          | 1.80     | 2.10 | 2.40 |
| E1         | 1.15     | 1.25 | 1.35 |
| e          | 0.65 BSC |      |      |
| L          | 0.26     | 0.36 | 0.46 |
| L1         | 0.42 REF |      |      |
| L2         | 0.15 BSC |      |      |
| $\theta$   | 0°       |      | 8°   |
| $\theta_1$ | 4°       |      | 10°  |



SIDE VIEW

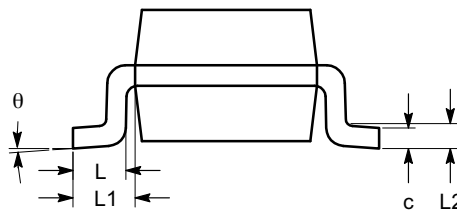

END VIEW

**Notes:**

- (1) All dimensions are in millimeters. Angles in degrees.
- (2) Complies with JEDEC MO-203.

|                         |                                     |  |
|-------------------------|-------------------------------------|--|
| <b>DOCUMENT NUMBER:</b> | <b>98AON34266E</b>                  | Electronic versions are uncontrolled except when accessed directly from the Document Repository. Printed versions are uncontrolled except when stamped "CONTROLLED COPY" in red. |
| <b>DESCRIPTION:</b>     | <b>SC-88 (SC-70 6 LEAD), 1.25X2</b> | <b>PAGE 1 OF 1</b>   |

ON Semiconductor and are trademarks of Semiconductor Components Industries, LLC dba ON Semiconductor or its subsidiaries in the United States and/or other countries. ON Semiconductor reserves the right to make changes without further notice to any products herein. ON Semiconductor makes no warranty, representation or guarantee regarding the suitability of its products for any particular purpose, nor does ON Semiconductor assume any liability arising out of the application or use of any product or circuit, and specifically disclaims any and all liability, including without limitation special, consequential or incidental damages. ON Semiconductor does not convey any license under its patent rights nor the rights of others.





**UDFN6 1.0X1.0, 0.35P**  
CASE 517DP  
ISSUE O

DATE 31 AUG 2016

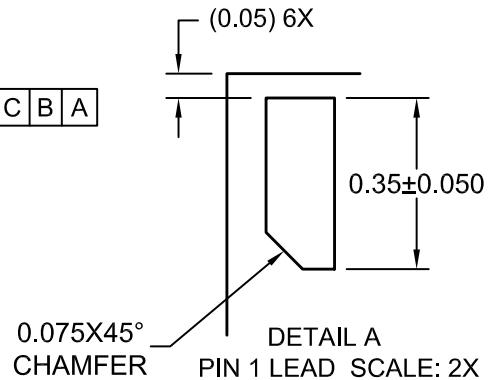

- NOTES:**
- A. COMPLIES TO JEDEC MO-252 STANDARD
  - B. DIMENSIONS ARE IN MILLIMETERS.
  - C. DIMENSIONS AND TOLERANCES PER ASME Y14.5M, 2009

|                         |                             |  |
|-------------------------|-----------------------------|--|
| <b>DOCUMENT NUMBER:</b> | <b>98AON13593G</b>          | Electronic versions are uncontrolled except when accessed directly from the Document Repository. Printed versions are uncontrolled except when stamped "CONTROLLED COPY" in red. |
| <b>DESCRIPTION:</b>     | <b>UDFN6 1.0X1.0, 0.35P</b> | <b>PAGE 1 OF 1</b>   |

ON Semiconductor and are trademarks of Semiconductor Components Industries, LLC dba ON Semiconductor or its subsidiaries in the United States and/or other countries. ON Semiconductor reserves the right to make changes without further notice to any products herein. ON Semiconductor makes no warranty, representation or guarantee regarding the suitability of its products for any particular purpose, nor does ON Semiconductor assume any liability arising out of the application or use of any product or circuit, and specifically disclaims any and all liability, including without limitation special, consequential or incidental damages. ON Semiconductor does not convey any license under its patent rights nor the rights of others.

ON Semiconductor and  are trademarks of Semiconductor Components Industries, LLC dba ON Semiconductor or its subsidiaries in the United States and/or other countries. ON Semiconductor owns the rights to a number of patents, trademarks, copyrights, trade secrets, and other intellectual property. A listing of ON Semiconductor's product/patent coverage may be accessed at [www.onsemi.com/site/pdf/Patent-Marking.pdf](http://www.onsemi.com/site/pdf/Patent-Marking.pdf). ON Semiconductor reserves the right to make changes without further notice to any products herein. ON Semiconductor makes no warranty, representation or guarantee regarding the suitability of its products for any particular purpose, nor does ON Semiconductor assume any liability arising out of the application or use of any product or circuit, and specifically disclaims any and all liability, including without limitation special, consequential or incidental damages. Buyer is responsible for its products and applications using ON Semiconductor products, including compliance with all laws, regulations and safety requirements or standards, regardless of any support or applications information provided by ON Semiconductor. "Typical" parameters which may be provided in ON Semiconductor data sheets and/or specifications can and do vary in different applications and actual performance may vary over time. All operating parameters, including "Typicals" must be validated for each customer application by customer's technical experts. ON Semiconductor does not convey any license under its patent rights nor the rights of others. ON Semiconductor products are not designed, intended, or authorized for use as a critical component in life support systems or any FDA Class 3 medical devices or medical devices with a same or similar classification in a foreign jurisdiction or any devices intended for implantation in the human body. Should Buyer purchase or use ON Semiconductor products for any such unintended or unauthorized application, Buyer shall indemnify and hold ON Semiconductor and its officers, employees, subsidiaries, affiliates, and distributors harmless against all claims, costs, damages, and expenses, and reasonable attorney fees arising out of, directly or indirectly, any claim of personal injury or death associated with such unintended or unauthorized use, even if such claim alleges that ON Semiconductor was negligent regarding the design or manufacture of the part. ON Semiconductor is an Equal Opportunity/Affirmative Action Employer. This literature is subject to all applicable copyright laws and is not for resale in any manner.

## PUBLICATION ORDERING INFORMATION

### LITERATURE FULFILLMENT:

Email Requests to: [orderlit@onsemi.com](mailto:orderlit@onsemi.com)

ON Semiconductor Website: [www.onsemi.com](http://www.onsemi.com)

### TECHNICAL SUPPORT

North American Technical Support:  
Voice Mail: 1 800-282-9855 Toll Free USA/Canada  
Phone: 011 421 33 790 2910

### Europe, Middle East and Africa Technical Support:

Phone: 00421 33 790 2910

For additional information, please contact your local Sales Representative