

GAS20S05-4

DC-DC Converter Technical Manual V1.0

Sixteenth-Brick
DC-DC Converter

36 - 75 V
Input

5 V Output

20 A Current

Negative
Logic

Description

The GAS20S05-4 is a new generation isolated DC-DC converter that uses an industry standard sixteenth-brick structure, featuring high efficiency and power density with low output ripple and noise. It operates from an input voltage range of 36 V to 75 V, and provides the rated output voltage of 5 V as well as the the maximum output current of 20 A.

Operational Features

- Input voltage: 36 - 75 V
- Output current: 0 - 20 A
- Efficiency: 92% (5 V, 20 A)

Mechanical Features

- Industry standard sixteenth-brick (L x W x H): 33.3 mm x 23.1 mm x 9.9 mm (1.31 in. x 0.91 in. x 0.39 in.)
- Weight: 16 g

Control Features

- Remote on/off
- Remote sense
- Output voltage trim

Protection Features

- Input undervoltage protection
- Output overcurrent protection (Hiccup mode)
- Output short circuit protection (Hiccup mode)
- Output overvoltage protection (Hiccup mode)
- Overtemperature protection (Self-recovery)

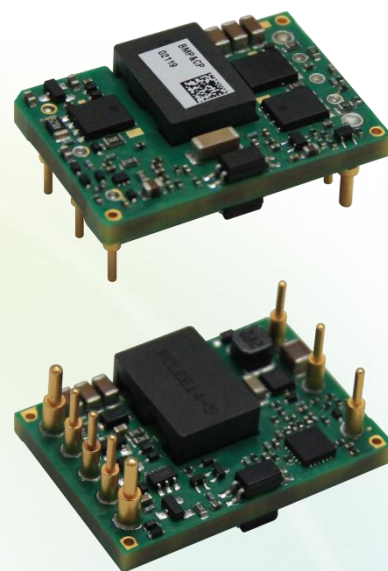

GAS20S05-4

Safety Features

- UL60950-1 and CSA C22.2 No. 60950-1
- RoHS6 compliant

Applications

- Servers
- Telecom and Data Communication Applications
- Industrial Equipment

GAS20S05-4

DC-DC Converter Technical Manual V1.0

Designation Explanation

GAS 20 S 05 - 4
 1 2 3 4 5

- 1 — 48Vin, high performance, analog control sixteenth-brick
- 2 — Output current: 20 A
- 3 — Single output
- 4 — Output voltage: 5 V
- 5 — Pin length: 4.8 mm



NOTE

EN41SADA on the label of the module is the internal model used by the manufacturer.

Mechanical Diagram

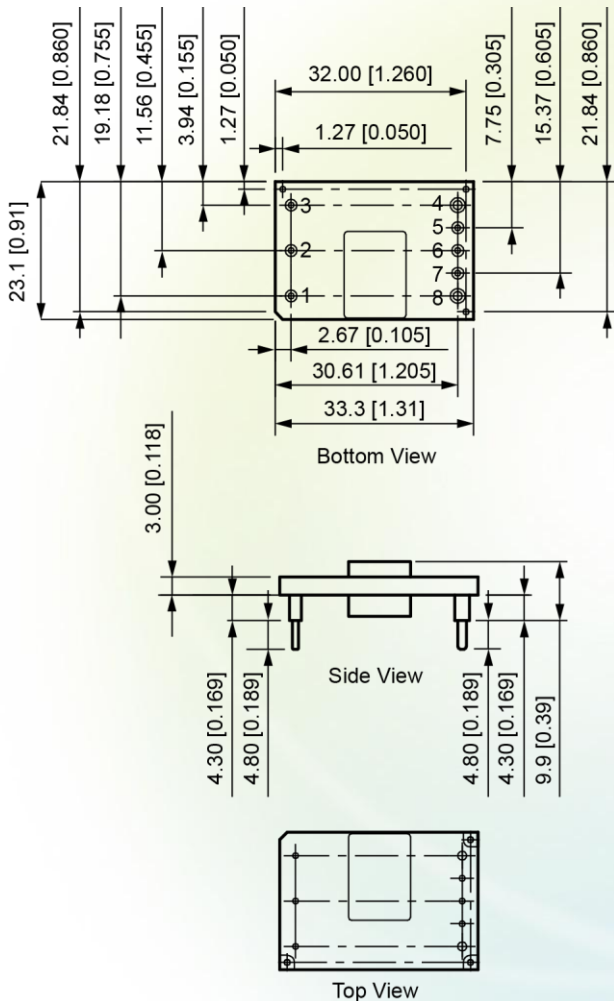

Pin Description

Pin No.	Function
1	V _{in} (+)
2	On/Off
3	V _{in} (-)
4	V _{out} (-)
5	Sense (-)
6	Trim
7	Sense (+)
8	V _{out} (+)



NOTE

- All dimensions in mm [in.]
 Tolerances: x.x ± 0.5 mm [x.xx ± 0.02 in.]
 x.xx ± 0.25 mm [x.xxx ± 0.010 in.]
- Pin 1-3, 5-7 are 1.00 ± 0.05 mm [0.040 ± 0.002 in.] diameter with 2.00 ± 0.10 mm [0.080 ± 0.004 in.] diameter standoff shoulders.
 Pin 4 and pin 8 are 1.50 ± 0.05 mm [0.060 ± 0.002 in.] diameter with 2.50 ± 0.10 mm [0.098 ± 0.004 in.] diameter standoff shoulders.

GAS20S05-4

DC-DC Converter Technical Manual V1.0

Electrical Specifications

Conditions: $T_A = 25^\circ\text{C}$ (77°F), Airflow = 1 m/s (200 LFM), $V_{in} = 48\text{ V}$, unless otherwise notes.

Parameter	Min.	Typ.	Max.	Unit	Notes & Conditions
Absolute maximum ratings					
Input voltage					
Continuous	-	-	80	V	-
Transient (100 ms)	-	-	100	V	-
Operating ambient temperature	-40	-	85	°C	See the thermal derating curve
Storage temperature	-55	-	125	°C	-
Operating humidity	10	-	95	% RH	Non-condensing
External voltage applied to On/Off	-	-	12	V	-
Input characteristics					
Operating input voltage	36	48	75	V	-
Maximum input current	-	-	4	A	$V_{in} = 0 - 75\text{ V}$; $I_{out} = 20\text{ A}$
No-load loss	-	3.2	-	W	$V_{in} = 48\text{ V}$; $I_{out} = 0\text{ A}$
Input capacitance	100	150	-	μF	Aluminum electrolytic capacitor
Inrush transient	-	-	1	A ² s	-
Input reflected ripple current (peak to peak)	-	-	20	mA	Oscilloscope bandwidth: 20 MHz
Output characteristics					
Output voltage set point	4.92	5.00	5.08	V	$V_{in} = 48\text{ V}$; $I_{out} = 10\text{ A}$
Output power	0	-	100	W	-
Output line regulation	-	-	± 0.3	%	$V_{in} = 36 - 75\text{ V}$; $I_{out} = 20\text{ A}$
Output load regulation	-	-	± 0.3	%	$V_{in} = 48\text{ V}$; $I_{out} = 0 - 20\text{ A}$
Regulated voltage precision	-	-	± 3	%	$V_{in} = 36 - 75\text{ V}$; $I_{out} = 0 - 20\text{ A}$
Temperature coefficient	-	-	± 0.02	%/°C	$T_A = -40^\circ\text{C}$ to $+85^\circ\text{C}$ (-40°F to $+185^\circ\text{F}$)
External capacitance	470	-	5000	μF	470 μF : solid aluminum capacitor If $T_A < -5^\circ\text{C}$, the additional capacitor ($\geq 1000\mu\text{F}$) needed for output
Output current	0	-	20	A	-
Output ripple and noise (peak to peak)	-	50	150	mV	Oscilloscope bandwidth: 20 MHz
Output voltage Trim range	80	-	110	%	-
Output voltage overshoot	-	-	5	%	The whole range of V_{in} , I_{out} and T_A
Output voltage delay time	-	-	100	ms	From V_{in} connection to $10\%V_{out}$
Output voltage rise time	-	9	20	ms	From $10\%V_{out}$ to $90\%V_{out}$

GAS20S05-4

DC-DC Converter Technical Manual V1.0

Electrical Specifications

Conditions: $T_A = 25^\circ\text{C}$ (77°F), Airflow = 1 m/s (200 LFM), $V_{in} = 48\text{ V}$, unless otherwise notes.

Parameter	Min.	Typ.	Max.	Units	Notes & Conditions
Output characteristics					
Switching frequency	-	400	-	kHz	-
Protection characteristics					
Input undervoltage protection					
Startup threshold	32	34	36	V	-
Shutdown threshold	30	32	34	V	-
Hysteresis	1	2	3	V	-
Output overcurrent protection	22	-	32	A	Hiccup mode
Output short circuit protection	-	-	-	-	Hiccup mode
Output overvoltage protection	6	-	7	V	Hiccup mode
Overtemperature protection					Self-recovery
Threshold	105	115	130	$^\circ\text{C}$	The values are obtained by measuring the temperature of the PCB near the thermal resistor.
Hysteresis	5	-	-	$^\circ\text{C}$	
Dynamic characteristics					
Overshoot amplitude	-	100	250	mV	Current change rate: 0.1 A/ μs Load: 25% - 50% - 25%; 50% - 75% - 50%
Recovery time	-	-	400	μs	
Overshoot amplitude	-	160	300	mV	Current change rate: 1 A/ μs Load: 25% - 50% - 25%; 50% - 75% - 50%
Recovery time	-	-	400	μs	
Efficiency					
100% load	91	92	-	%	$V_{in} = 48\text{ V}$; $I_{out} = 20\text{ A}$
60% load	90	91	-	%	$V_{in} = 48\text{ V}$; $I_{out} = 12\text{ A}$
50% load	90	91	-	%	$V_{in} = 48\text{ V}$; $I_{out} = 10\text{ A}$
20% load	84	85	-	%	$V_{in} = 48\text{ V}$; $I_{out} = 4\text{ A}$
Isolation characteristics					
Input to output Isolation voltage	-	-	1500	V DC	Basic Isolation
Other characteristics					
Remote on/off voltage					
Low level	-0.7	-	1.2	V	Negative logic
High level	3.5	-	12	V	
On/Off current					
Low level	-	-	1.0	mA	-
High level	-	-	-	μA	-

GAS20S05-4

DC-DC Converter Technical Manual V1.0

Electrical Specifications

Conditions: $T_A = 25^{\circ}\text{C}$ (77°F), Airflow = 1 m/s (200 LFM), $V_{in} = 48\text{ V}$, unless otherwise notes.

Parameter	Min.	Typ.	Max.	Units	Notes & Conditions
Reliability characteristics					
Mean time between failures (MTBF)	-	2.5	-	Million hours	Telcordia, SR332 Method 1 Case3; 80% load; Airflow = 1.5 m/s (300LFM); $T_A = 40^{\circ}\text{C}$ (104°F)

Specifications are subject to change without notice.

Characteristic Curves

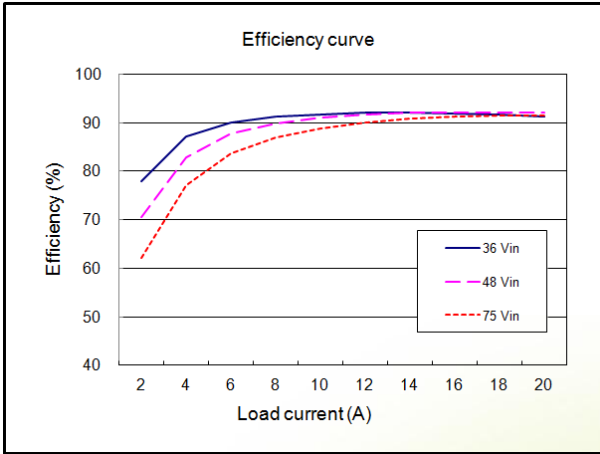

Figure 1: Efficiency ($T_A = 25^\circ\text{C}$ [77°F])

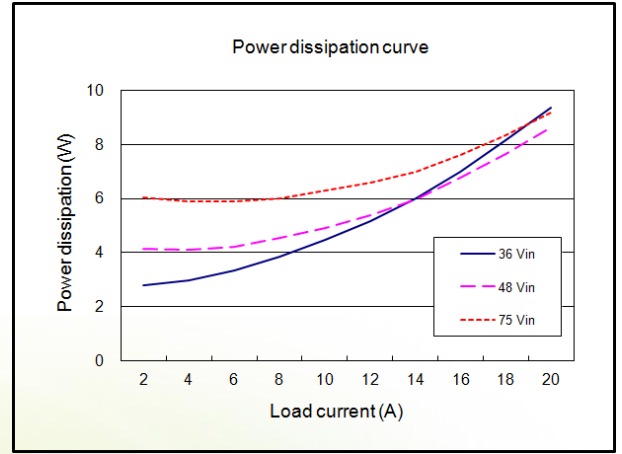

Figure 2: Power dissipation ($T_A = 25^\circ\text{C}$ [77°F])

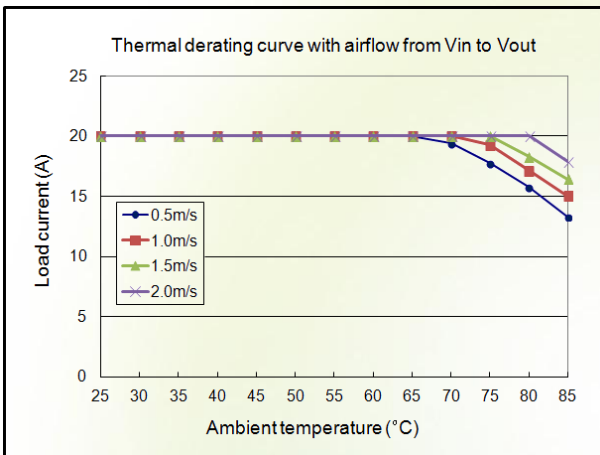

Figure 3: Thermal derating with airflow from V_{in} to V_{out} ($V_{in} = 48\text{ V}$; $V_{out} = 5\text{ V}$)

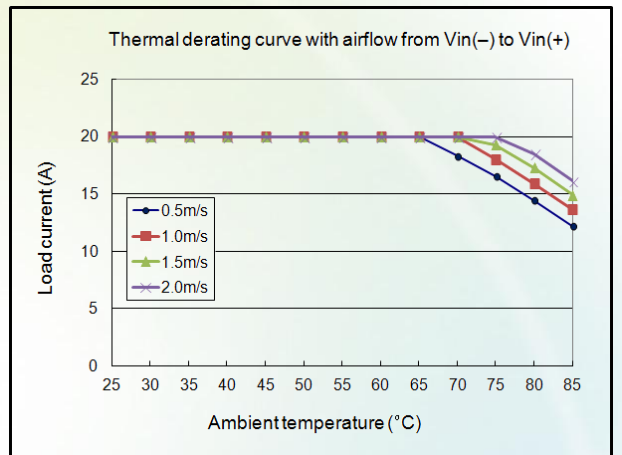

Figure 4: Thermal derating with airflow from $V_{in}(-)$ to $V_{in}(+)$ ($V_{in} = 48\text{ V}$; $V_{out} = 5\text{ V}$)

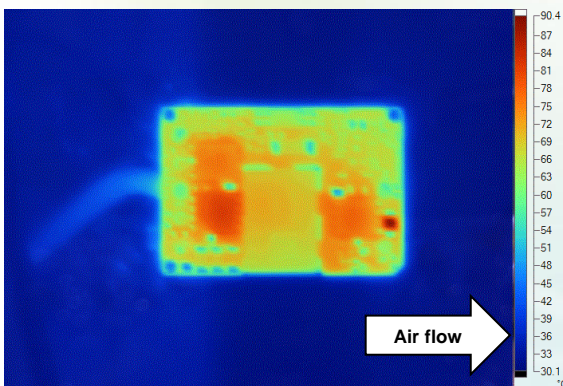

Figure 5: Thermal plot with airflow from V_{in} to V_{out} ($T_A = 25^\circ\text{C}$ [77°F]; Airflow = 1 m/s [200 LFM]; $V_{in} = 48\text{ V}$; $V_{out} = 5\text{ V}$; $I_{out} = 20\text{ A}$)

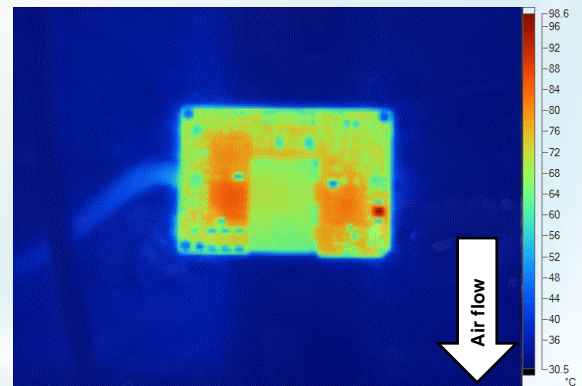

Figure 6: Thermal plot with airflow from $V_{in}(-)$ to $V_{in}(+)$ ($T_A = 25^\circ\text{C}$ [77°F]; Airflow = 1 m/s [200 LFM]; $V_{in} = 48\text{ V}$; $V_{out} = 5\text{ V}$; $I_{out} = 20\text{ A}$)

GAS20S05-4

DC-DC Converter Technical Manual V1.0

Typical Waveforms



NOTE

1. During the test of input reflected ripple current, the input terminal must be connected to the external input filter (include a 12 μH inductor and a 220 μF electrolytic capacitor), which is not required in other tests.
2. Point B and C, which are for testing the output voltage ripple, is 25 mm (0.98 in.) away from the $V_{\text{out}(+)}$ pin and the $V_{\text{out}(-)}$ pin.

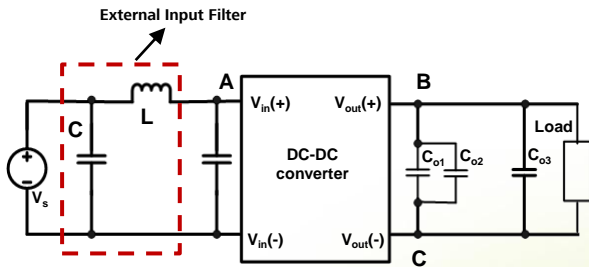

Figure 7: Test set-up diagram

- C_{in} : The aluminum electrolytic capacitor (100 μF) is recommended.
- C_{o1} : The 0.1 μF ceramic capacitor is recommended.
- C_{o2} : The 10 μF tantalum capacitor is recommended.
- C_{o3} : The 470 μF solid aluminum capacitor is recommended.

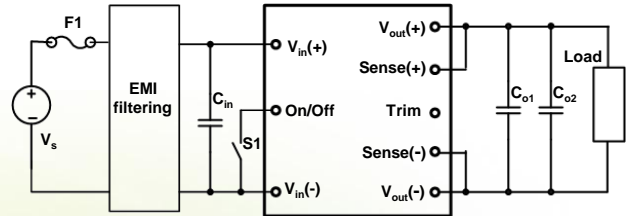

Figure 8: Typical circuit applications

- F1: 7 A fuse (fast blowing)
- C_{in} : The aluminum electrolytic capacitor (100 μF) is recommended.
- C_{o1} : The 1 μF ceramic capacitor is recommended.
- C_{o2} : The 470 μF solid aluminum capacitor is recommended.

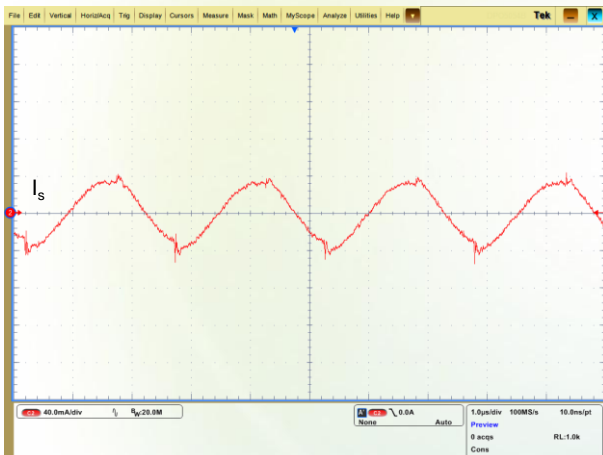

Figure 9: Input reflected ripple current (for point A in the test set-up diagram, $V_{\text{in}} = 48 \text{ V}$, $V_{\text{out}} = 5 \text{ V}$, $I_{\text{out}} = 20 \text{ A}$)

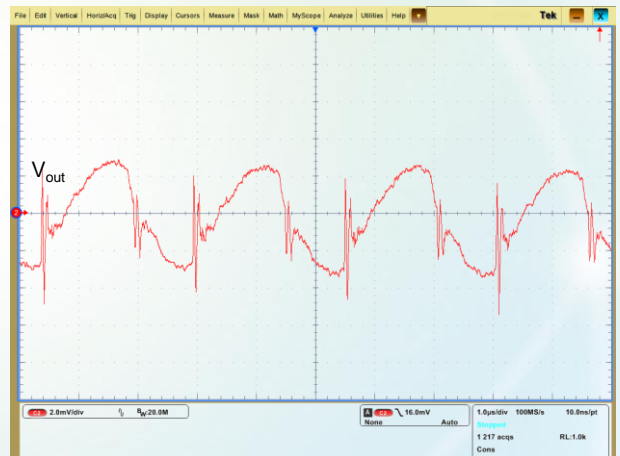

Figure 10: Output voltage ripple (for point BC in the test set-up diagram, $V_{\text{in}} = 48 \text{ V}$, $V_{\text{out}} = 5 \text{ V}$, $I_{\text{out}} = 20 \text{ A}$)

GAS20S05-4

DC-DC Converter Technical Manual V1.0

Typical Waveforms

Conditions: $T_A = 25^\circ\text{C}$ (77°F), $V_{in} = 48\text{ V}$.

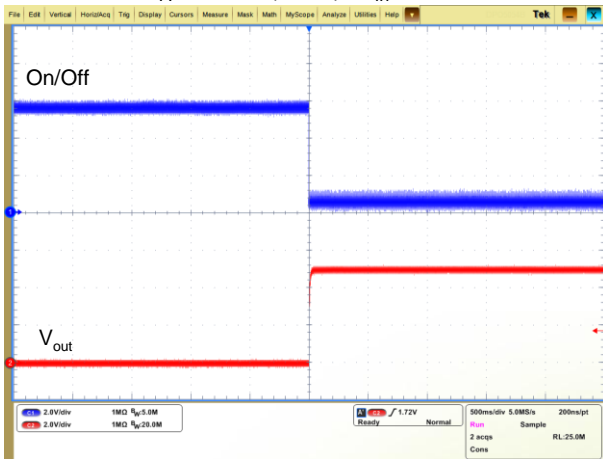

Figure 11: Startup from On/Off

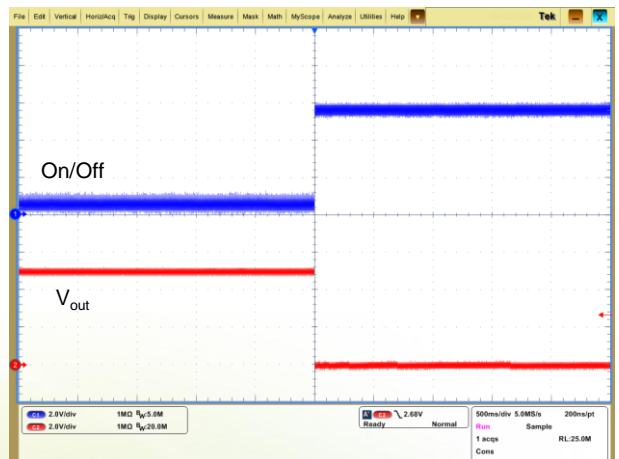

Figure 12: Shutdown from On/Off



Figure 13: Startup by power on

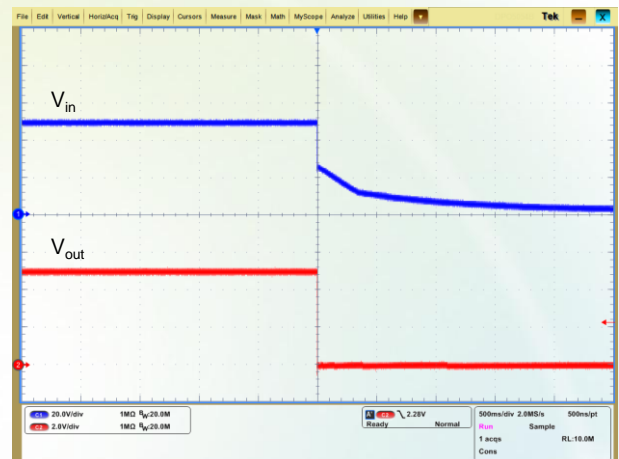

Figure 14: Shutdown by power off

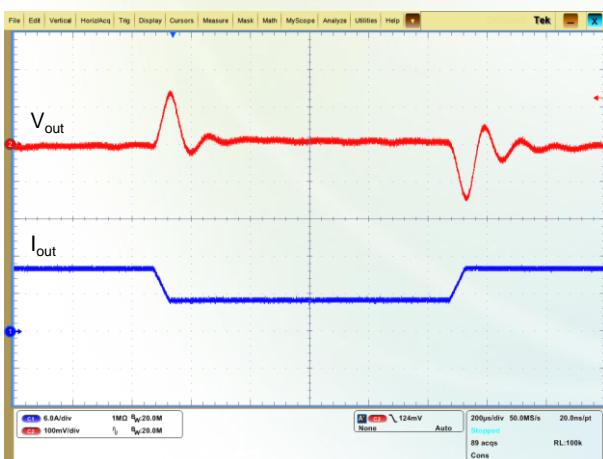

Figure 15: Output voltage dynamic response (Load: 25% - 50% - 25%, $di/dt = 0.1\text{ A}/\mu\text{s}$)

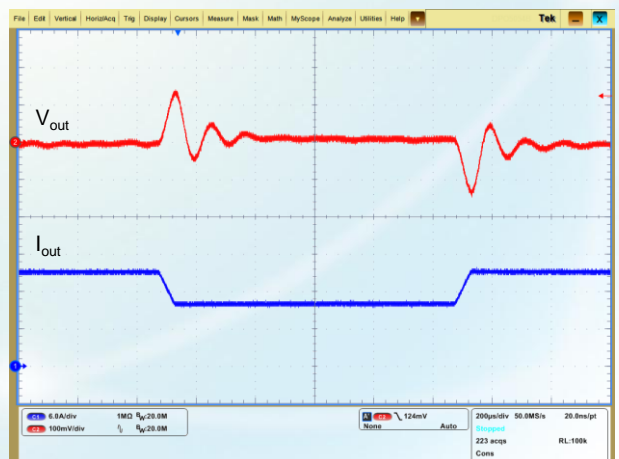

Figure 16: Output voltage dynamic response (Load: 50% - 75% - 50%, $di/dt = 0.1\text{ A}/\mu\text{s}$)

Remote On/Off

Logic Enable	On/Off Pin Level	Status
Negative logic	Low level	On
	High level or left open	Off

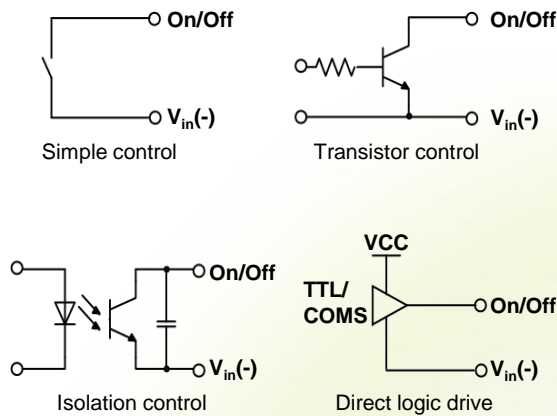

Figure 17: Various circuits for driving the On/Off pin

Remote Sense

This function is used to compensate for voltage drops on R_w . The Sense(+), Sense(-), $V_{out}(+)$, and $V_{out}(-)$ terminals should meet the following requirements:

$$[V_{out}(+) - V_{out}(-)] - [\text{Sense}(+) - \text{Sense}(-)] \leq 10\% \times V_{nom}$$

(V_{nom} is the rated output voltage.)

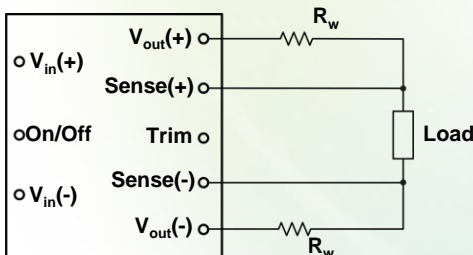

Figure 18: Configuration diagram for remote sense

R_w indicates the line impedance between the output terminal and the load.

If the remote sense function is disabled, the Sense(+) terminal directly connects to the $V_{out}(+)$ terminal and the Sense(-) terminal directly connects to the $V_{out}(-)$ terminal.

Output Voltage Trim

The output voltage can be adjusted according to the trim range specification by using the Trim pin.

Trim Up

The output voltage can be increased by installing an external resistor between the Trim pin and the Sense(+) pin.

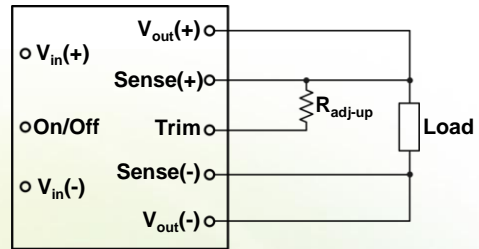

Figure 19: Configuration diagram for Trim up

The relationship between R_{adj-up} and V_{out} :

$$R_{adj-up} = \frac{5.1 \times V_{nom} \times (100 + \Delta)}{1.225 \times \Delta} - \frac{510}{\Delta} - 10.2(k\Omega)$$

$$\Delta = \frac{V_{out} - V_{nom}}{V_{nom}} \times 100$$



NOTE

1. If the Trim pin is not used, it should be left open.
2. Ensure that the actual output power does not exceed the maximum output power when raising the voltage.

Trim Down

The output voltage can be decreased by installing an external resistor between the Trim pin and the Sense(-) pin.

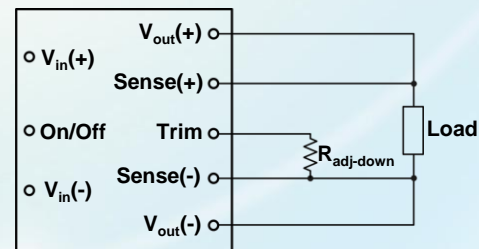

Figure 20: Configuration diagram for Trim down

The relationship between $R_{adj-down}$ and V_{out} :

$$R_{adj-down} = \frac{510}{\Delta} - 10.2(k\Omega) \quad \Delta = \frac{V_{nom} - V_{out}}{V_{nom}} \times 100$$

Input Undervoltage Protection

The converter will shut down after the input voltage drops below the undervoltage protection threshold for shutdown. The converter will start to work again after the input voltage reaches the input undervoltage protection threshold for startup. For the Hysteresis, see the **Protection characteristics**.

Output Overcurrent Protection

The converter equipped with current limiting circuitry can provide protection from an output overload or short circuit condition. If the output current exceeds the output overcurrent protection threshold, the converter enters hiccup mode. When the fault condition is removed, the converter will automatically restart.

Output Overvoltage Protection

When the voltage directly across the output pins exceeds the output overvoltage protection threshold, the converter will enter hiccup mode. When the fault condition is removed, the converter will automatically restart.

Overtemperature Protection

A temperature sensor on the converter senses the average temperature of the module. It protects the converter from being damaged at high temperatures. When the temperature exceeds the overtemperature protection threshold, the output will shut down. It will allow the converter to turn on again when the temperature of the sensed location falls by the value of **Overtemperature Protection Hysteresis**.

Recommend Reverse Polarity Protection Circuit

Reverse polarity protection is recommended under installation and cabling conditions where reverse polarity across the input may occur.

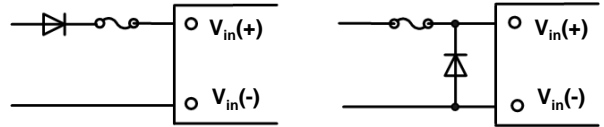

Figure 21: Recommend reverse polarity protection circuits

Recommended Fuse

The converter has no internal fuse. To meet safety and regulatory requirements, a 7 A fuse is recommended.

EMC

Figure 22 shows the EMC test set-up diagram. The acceptance standard is required as the conducted emission limits of CISPR22 Class A with 6 dB margin.

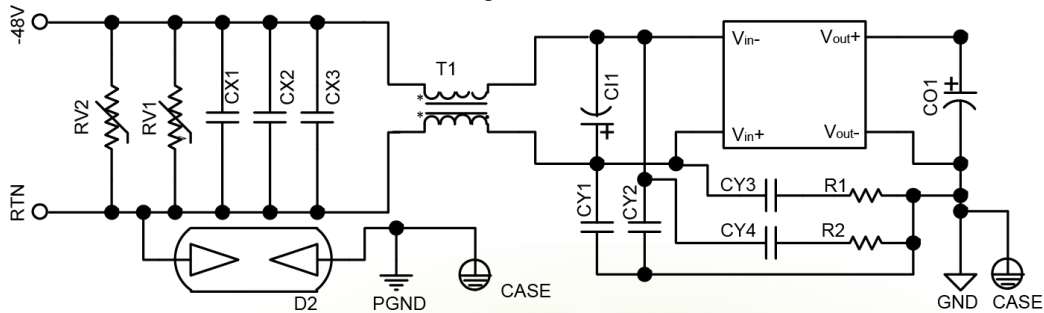

Figure 22: EMC test set-up diagram

RV1, RV2: Varistor, 100 V, 4500 A
D2: Gas discharge tube, 90 V, 10 kA

C11: Aluminum electrolytic capacitor, 100 μ F
CO1: Solid aluminum capacitor, 470 μ F

CX1, CX2, CX3: Metalized film capacitor, 1 μ F, 275 V
CY1, CY2: Metalized film capacitor, 0.1 μ F, 275 V
CY3, CY4: Chip multilayer ceramic capacitor, 22 nF, 1000 V

R1, R2: Chip thick film resistor, 1 W, 1 Ω
T1: Common mode inductor, single phase, 400 μ H

Qualification Testing

Parameter	Units	Condition
High Accelerated Life Test (HALT)	3	Low temperature limit: -60°C (-76°F); high temperature limit: 110°C (230°F); vibration limit: 40 G
Temperature Humidity Bias (THB)	8	Maximum input voltage; 85°C (185°F); 85% RH; 1000 operating hours under lowest load power
High Temperature Operation Bias (HTOB)	8	Rated input voltage; air flow: 0.5 m/s (100 LFM) to 5 m/s (1000 LFM); ambient temperature between +45°C (+113°F) and +55°C (+131°F); 1000 operating hours; 50% to 80% load
Power and Temperature Cycling Test (PTC)	8	Rated input voltage; air flow: 0.5 m/s (100 LFM) to 5 m/s (1000 LFM); ambient temperature between -40°C (-40°F) and +85°C (+185°F); 1000 operating hours; 50% load; temperature slope: 15°C (59°F) per minute

GAS20S05-4

DC-DC Converter Technical Manual V1.0

Thermal Consideration

Thermal Test Point

Decide proper airflow to be provided by measuring the temperature of the PCB near the at part 1 in the Figure 23 to protect the converter against overtemperature. The Overtemperature protection threshold is also obtained based on this thermal test point.



Figure 23: Thermal test point

Power Dissipation

The converter power dissipation is calculated based on efficiency. The following formula reflects the relationship between the consumed power (P_d), efficiency (η), and output power (P_o): $P_d = P_o(1-\eta)/\eta$

Moisture Sensitivity Level (MSL) Rating

The converters have a MSL rating of 1.

Mechanical Consideration

Installation

Although the converter can be mounted in any direction, free airflow must be taken.

Soldering (RoHS5)

The converter is compatible with standard wave soldering, reflow soldering or hand soldering.

1. For wave soldering, the converter pins can be soldered at 255°C (491°F) for less than 7 seconds.
2. For reflow soldering, the converter pins can be soldered at 230°C (446°F) for less than 10 seconds.
3. For hand soldering, the iron temperature should be maintained at 300°C (572°F) to 380°C (716°F) and applied to the converter pins for less than 10 seconds.

The converter can be rinsed using the isopropyl alcohol (IPA) solvent or other proper solvents.

Soldering (RoHS6)

The converter is compatible with standard wave soldering, reflow soldering or hand soldering.

1. For wave soldering, the converter pins can be soldered at 260°C (500°F) for less than 7 seconds.
2. For reflow soldering, the converter pins can be soldered at 260°C (500°F) for less than 10 seconds.
3. For hand soldering, the iron temperature should be maintained at 350°C (662°F) to 420°C (788°F) and applied to the converter pins for less than 10 seconds.

The converter can be rinsed using the isopropyl alcohol (IPA) solvent or other proper solvents.

HUAWEI TECHNOLOGIES CO., LTD.
Huawei Industrial Base Bantian Longgang
Shenzhen 518129
People's Republic of China
www.huawei.com