

DMC 1,5/20-G1-3,5 P26THR - PCB header



1874438

<https://www.phoenixcontact.com/us/products/1874438>

Please be informed that the data shown in this PDF document is generated from our online catalog. Please find the complete data in the user documentation. Our general terms of use for downloads are valid.

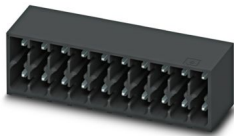

PCB headers, nominal cross section: 1.5 mm², color: black, nominal current: 8 A, rated voltage (III/2): 160 V, contact surface: Tin, contact connection type: Pin, number of potentials: 40, number of rows: 2, number of positions: 20, number of connections: 40, product range: DMC 1,5/..-G1-THR, pitch: 3.5 mm, mounting: THR soldering / wave soldering, pin layout: Linear pinning, solder pin [P]: 2.6 mm, number of solder pins per potential: 1, plug-in system: COMBICON DFMC 1,5, Pin connector pattern alignment: Standard, locking: without, mounting: without, type of packaging: packed in cardboard

Your advantages

- Designed for integration into the SMT soldering process
- Conductor connection on several levels enables higher contact density
- Small component size for applications where space is at a premium

Commercial data

| | |
|--------------------------------------|--------------------------------|
| Item number | 1874438 |
| Packing unit | 50 pc |
| Minimum order quantity | 1 pc |
| Note | Made to order (non-returnable) |
| Product key | AABTJB |
| GTIN | 4055626338767 |
| Weight per piece (including packing) | 10.36 g |
| Weight per piece (excluding packing) | 9.2 g |
| Country of origin | CN |

DMC 1,5/20-G1-3,5 P26THR - PCB header



1874438

<https://www.phoenixcontact.com/us/products/1874438>

Technical data

Product properties

| | |
|---------------------------|-----------------------|
| Product type | PCB headers |
| Product family | DMC 1,5/..-G1-THR |
| Product line | COMBICON Connectors S |
| Type | Headers |
| Number of positions | 20 |
| Pitch | 3.5 mm |
| Number of connections | 40 |
| Number of rows | 2 |
| Number of potentials | 40 |
| Mounting flange | without |
| Pin layout | Linear pinning |
| Solder pins per potential | 1 |

Electrical properties

| | |
|-----------------------------|--------------|
| Nominal current I_N | 8 A |
| Nominal voltage U_N | 160 V |
| Contact resistance | 2 m Ω |
| Rated voltage (III/3) | 160 V |
| Rated surge voltage (III/3) | 2.5 kV |
| Rated voltage (III/2) | 160 V |
| Rated surge voltage (III/2) | 2.5 kV |
| Rated voltage (II/2) | 250 V |
| Rated surge voltage (II/2) | 2.5 kV |

Mounting

| | |
|---------------|--------------------------------|
| Mounting type | THR soldering / wave soldering |
| Pin layout | Linear pinning |

Processing notes

| | |
|----------------------------------|-----------------------|
| Process | Reflow/wave soldering |
| Moisture Sensitive Level | MSL 1 |
| Classification temperature T_c | 260 °C |
| Solder cycles in the reflow | 3 |

Material specifications

Material data - contact

| | |
|--|--|
| Note | WEEE/RoHS-compliant, free of whiskers according to IEC 60068-2-82/JEDEC JESD 201 |
| Contact material | Cu alloy |
| Surface characteristics | Tin-plated |
| Metal surface contact area (top layer) | Tin (3 - 5 μm Sn) |

DMC 1,5/20-G1-3,5 P26THR - PCB header



1874438

<https://www.phoenixcontact.com/us/products/1874438>

| | |
|---|------------------------|
| Metal surface contact area (middle layer) | Nickel (1.3 - 3 µm Ni) |
| Metal surface soldering area (top layer) | Tin (3 - 5 µm Sn) |
| Metal surface soldering area (middle layer) | Nickel (1.3 - 3 µm Ni) |

Material data - housing

| | |
|--|--------------|
| Color (Housing) | black (9005) |
| Insulating material | LCP |
| Insulating material group | IIIa |
| CTI according to IEC 60112 | 175 |
| Flammability rating according to UL 94 | V0 |

Dimensions

| | |
|-----------------------|--------------|
| Dimensional drawing | |
| Pitch | 3.5 mm |
| Width [w] | 70.8 mm |
| Height [h] | 13.4 mm |
| Length [l] | 11.6 mm |
| Installed height | 10.8 mm |
| Solder pin length [P] | 2.6 mm |
| Pin dimensions | 0.8 x 0.8 mm |

PCB design

| | |
|---------------|---------|
| Pin spacing | 2.50 mm |
| Hole diameter | 1.4 mm |

Mechanical tests

Visual inspection

| | |
|---------------|-----------------------|
| Specification | IEC 60512-1-1:2002-02 |
| Result | Test passed |

Dimension check

| | |
|---------------|-----------------------|
| Specification | IEC 60512-1-2:2002-02 |
| Result | Test passed |

Resistance of inscriptions

| | |
|---------------|------------------------|
| Specification | IEC 60068-2-70:1995-12 |
| Result | Test passed |

Polarization and coding

| | |
|---------------|------------------------|
| Specification | IEC 60512-13-5:2006-02 |
| Result | Test passed |

DMC 1,5/20-G1-3,5 P26THR - PCB header



1874438

<https://www.phoenixcontact.com/us/products/1874438>

Contact holder in insert

| | |
|--|------------------------|
| Specification | IEC 60512-15-1:2008-05 |
| Contact holder in insert Requirements >20 N | Test passed |

Insertion and withdrawal forces

| | |
|-------------------------------------|-------------|
| Result | Test passed |
| No. of cycles | 25 |
| Insertion strength per pos. approx. | 3 N |
| Withdraw strength per pos. approx. | 2 N |

Electrical tests

Thermal test | Test group C

| | |
|----------------------------|-----------------------|
| Specification | IEC 60512-5-1:2002-02 |
| Tested number of positions | 20 |

Insulation resistance

| | |
|--|-----------------------|
| Specification | IEC 60512-3-1:2002-02 |
| Insulation resistance, neighboring positions | > 5 MΩ |

Air clearances and creepage distances |

| | |
|--|---------------------|
| Specification | IEC 60664-1:2007-04 |
| Insulating material group | IIIa |
| Comparative tracking index (IEC 60112) | CTI 175 |
| Rated insulation voltage (III/3) | 160 V |
| Rated surge voltage (III/3) | 2.5 kV |
| minimum clearance value - non-homogenous field (III/3) | 1.5 mm |
| minimum creepage distance (III/3) | 2.5 mm |
| Rated insulation voltage (III/2) | 160 V |
| Rated surge voltage (III/2) | 2.5 kV |
| minimum clearance value - non-homogenous field (III/2) | 1.5 mm |
| minimum creepage distance (III/2) | 1.6 mm |
| Rated insulation voltage (II/2) | 250 V |
| Rated surge voltage (II/2) | 2.5 kV |
| minimum clearance value - non-homogenous field (II/2) | 1.5 mm |
| minimum creepage distance (II/2) | 2.5 mm |

Environmental and real-life conditions

Vibration test

| | |
|---------------|-----------------------------|
| Specification | IEC 60068-2-6:2007-12 |
| Frequency | 10 - 150 - 10 Hz |
| Sweep speed | 1 octave/min |
| Amplitude | 0.35 mm (10 Hz ... 60.1 Hz) |
| Acceleration | 5g (60.1 Hz ... 150 Hz) |

DMC 1,5/20-G1-3,5 P26THR - PCB header



1874438

<https://www.phoenixcontact.com/us/products/1874438>

| | |
|------------------------|-------|
| Test duration per axis | 2.5 h |
|------------------------|-------|

Durability test

| | |
|--|-----------------------|
| Specification | IEC 60512-9-1:2010-03 |
| Impulse withstand voltage at sea level | 2.95 kV |
| Contact resistance R ₁ | 2 mΩ |
| Contact resistance R ₂ | 2.3 mΩ |
| Insertion/withdrawal cycles | 25 |

Climatic test

| | |
|-----------------------------------|---|
| Specification | ISO 6988:1985-02 |
| Corrosive stress | 0.2 dm ³ SO ₂ on 300 dm ³ /40 °C/1 cycle |
| Thermal stress | 100 °C/168 h |
| Power-frequency withstand voltage | 1.39 kV |

Ambient conditions

| | |
|---|---|
| Ambient temperature (operation) | -40 °C ... 100 °C (dependent on the derating curve) |
| Ambient temperature (storage/transport) | -40 °C ... 70 °C |
| Relative humidity (storage/transport) | 30 % ... 70 % |
| Ambient temperature (assembly) | -5 °C ... 100 °C |

Packaging specifications

| | |
|-------------------|---------------------|
| Type of packaging | packed in cardboard |
|-------------------|---------------------|

DMC 1,5/20-G1-3,5 P26THR - PCB header

1874438

<https://www.phoenixcontact.com/us/products/1874438>

Drawings

Dimensional drawing

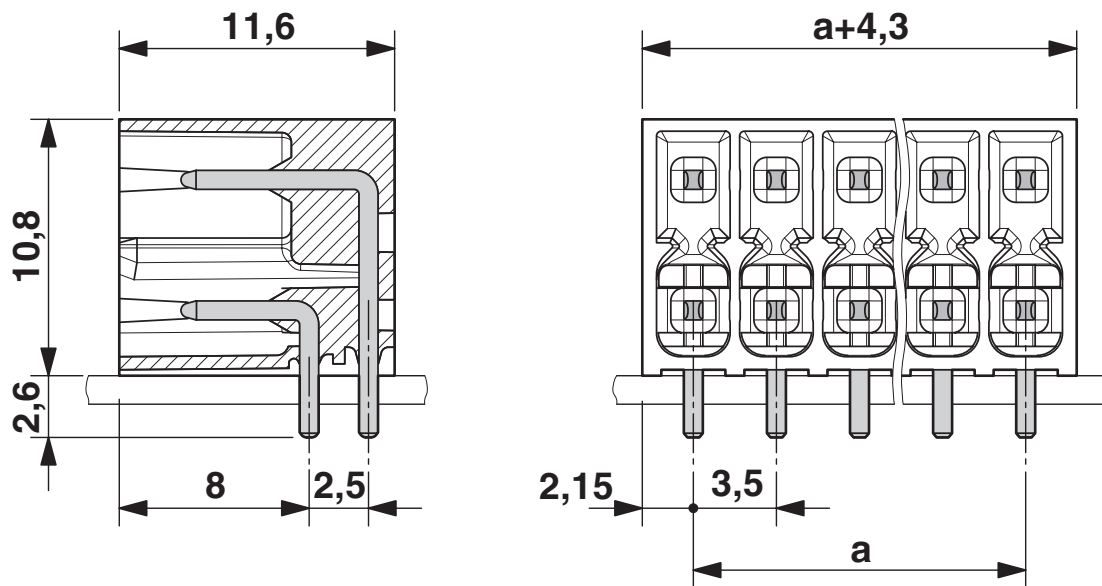

Drilling plan/solder pad geometry

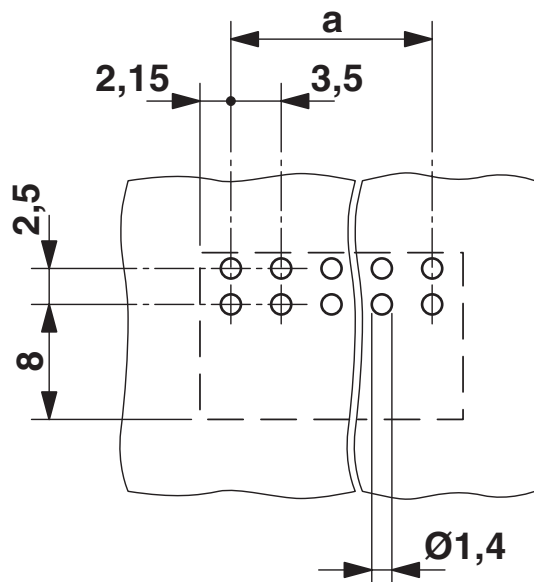

DMC 1,5/20-G1-3,5 P26THR - PCB header

1874438

<https://www.phoenixcontact.com/us/products/1874438>

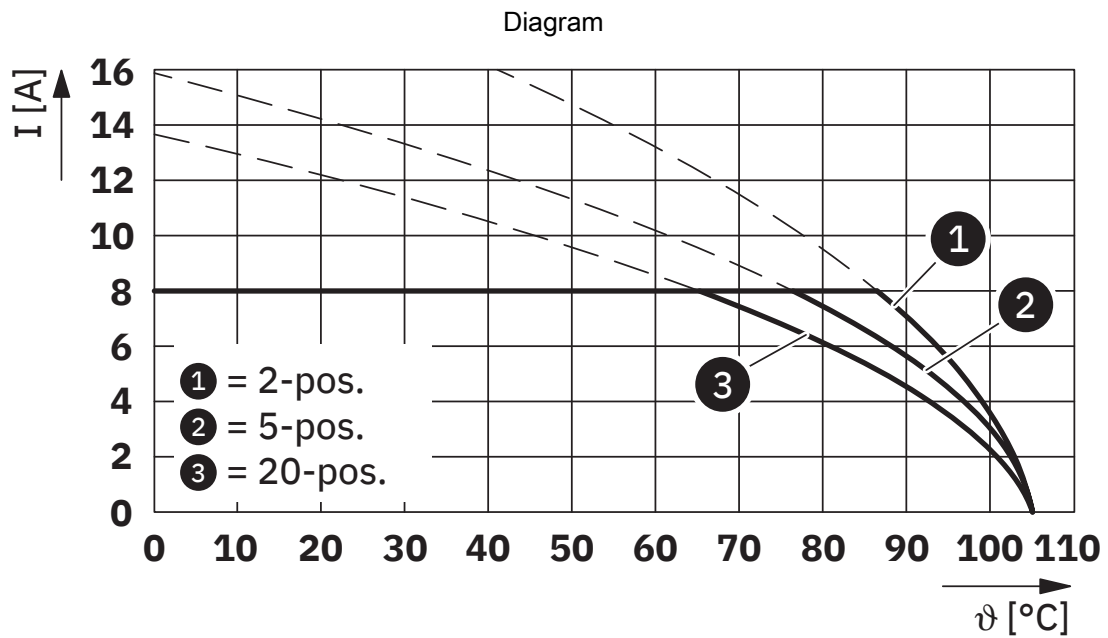

Type: DFMC 1,5/...-ST-3,5 with DMC 1,5/...-G1-3,5 P20 THR

DMC 1,5/20-G1-3,5 P26THR - PCB header





1874438

<https://www.phoenixcontact.com/us/products/1874438>

Approvals

To download certificates, visit the product detail page: <https://www.phoenixcontact.com/us/products/1874438>

|  cULus Recognized Approval ID: E60425-20110128 | | | | |
|---|-----------------------|-----------------------|-------------------|-----------------------------|
| | Nominal voltage U_N | Nominal current I_N | Cross section AWG | Cross section mm^2 |
| Use group B | 300 V | 8 A | - | - |
| Use group C | 50 V | 8 A | - | - |
| Use group D | 300 V | 8 A | - | - |

|  VDE Gutachten mit Fertigungsüberwachung Approval ID: 40038423 | | | | |
|---|-----------------------|-----------------------|-------------------|-----------------------------|
| | Nominal voltage U_N | Nominal current I_N | Cross section AWG | Cross section mm^2 |
| | 160 V | 8 A | - | - |

DMC 1,5/20-G1-3,5 P26THR - PCB header



1874438

<https://www.phoenixcontact.com/us/products/1874438>

Classifications

ECLASS

| | |
|-------------|----------|
| ECLASS-11.0 | 27460201 |
| ECLASS-12.0 | 27460201 |
| ECLASS-13.0 | 27460201 |

ETIM

| | |
|----------|----------|
| ETIM 9.0 | EC002637 |
|----------|----------|

UNSPSC

| | |
|-------------|----------|
| UNSPSC 21.0 | 39121400 |
|-------------|----------|

DMC 1,5/20-G1-3,5 P26THR - PCB header



1874438

<https://www.phoenixcontact.com/us/products/1874438>

Environmental product compliance

EU RoHS

| | |
|---|--------------------|
| Fulfills EU RoHS substance requirements | Yes, No exemptions |
|---|--------------------|

China RoHS

| | |
|--|--|
| Environment friendly use period (EFUP) | EFUP-E |
| | No hazardous substances above the limits |

EU REACH SVHC

| | |
|-------------------------------------|----------------------------|
| REACH candidate substance (CAS No.) | No substance above 0.1 wt% |
|-------------------------------------|----------------------------|

DMC 1,5/20-G1-3,5 P26THR - PCB header



1874438

<https://www.phoenixcontact.com/us/products/1874438>

Accessories

CP-DMC 1,5 NAT - Coding profile

1790647

<https://www.phoenixcontact.com/us/products/1790647>

Coding profile, for insertion between the coding ribs of the connector and the header following the reflow soldering process, insulating material, color: natural



DFMC 1,5/20-ST-3,5 - PCB connector

1790289

<https://www.phoenixcontact.com/us/products/1790289>

PCB connector, nominal cross section: 1.5 mm², color: green, nominal current: 8 A, rated voltage (III/2): 160 V, contact surface: Tin, contact connection type: Socket, number of potentials: 40, number of rows: 2, number of positions: 20, number of connections: 40, product range: DFMC 1,5/..-ST, pitch: 3.5 mm, connection method: Push-in spring connection, conductor/PCB connection direction: 0 °, plug-in system: COMBICON DFMC 1,5, locking: without, mounting: without, type of packaging: packed in cardboard

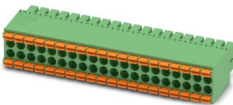

Phoenix Contact 2024 © - all rights reserved

<https://www.phoenixcontact.com>

Phoenix Contact USA

586 Fulling Mill Road

Middletown, PA 17057, United States

(+717) 944-1300

info@phoenixcon.com