

AT-CUT CRYSTAL UNIT (SMD · Ceramic Package)

RoHS compliant / Pb free

CS325S

3,000pcs/reel

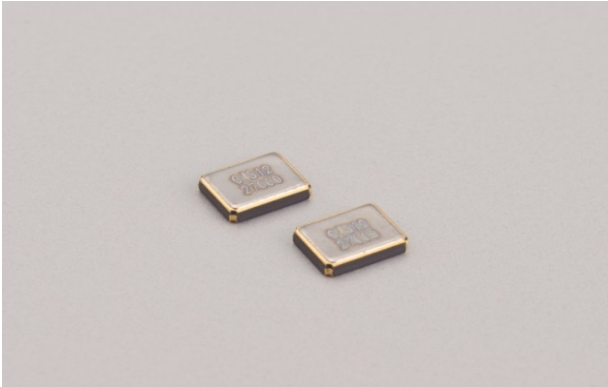

FEATURES

- Ultra-lightweight microminiature AT Crystal units SMD type
- Frequency range : 12.0 ~ 54.0MHz
- External dimensions (mm)
L : 3.3 x W : 2.6 x H : 0.7
- Applications
Small mobile devices / Consumer products

DIMENSION [mm]

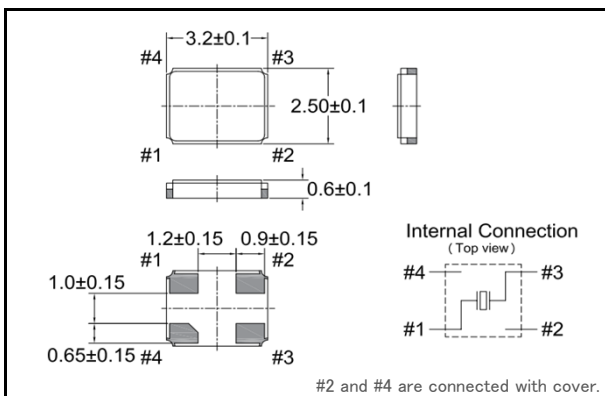

SOLDER PAD LAYOUT [mm]

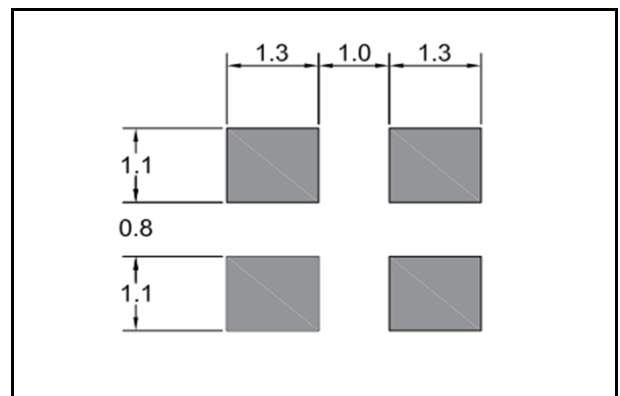

STANDARD SPECIFICATIONS

Item	Model	CS325S	Conditions
Nominal Frequency	f_0	12.0MHz ~ 54.0MHz (Fundamental)	Please contact us for frequencies available
Frequency Tolerance	$\Delta f/f_0$	± 30 ppm	at 25°C
Frequency Tolerance over Operating Temperature Range	$\Delta f/f_0$	± 30 ppm	-10°C ~ +60°C
Operating Temperature Range	T_{OPR}	-40°C ~ +85°C	
Storage Temperature Range	T_{STR}	-55°C ~ +125°C	
Motional (series) resistance	R_1	Refer to the following table	at 25°C
Load capacitance	C_L	10.0pF ~ ∞	Please specify your requirement
Shunt capacitance	C_0	5.0pF Max.	
Level of drive	DL	100 μ W Max.	
Insulation Resistance	I_R	500M Ω Min.	DC100V \pm 15V
Aging (first year)	$\Delta f/f_0$	± 5 ppm Max.	25°C \pm 3°C

MOTIONAL (SERIES) RESISTANCE (R1)

Freq. Range (MHz)	$12.0 \leq f_0 < 16.0$	$16.0 \leq f_0 < 20.0$	$20.0 \leq f_0 < 30.0$	$30.0 \leq f_0 < 54.0$
R_1	150 Ω Max.	120 Ω Max.	80 Ω Max.	50 Ω Max.

■ PART NUMBERING SYSTEM

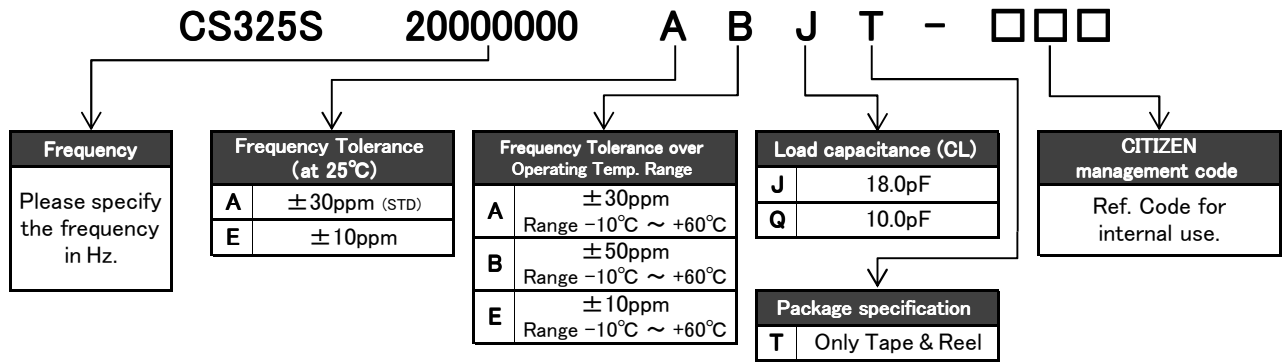

*Please contact us for specifications available.

■ Part Marking [standard]



C : Manufacture's ID Code

y : The last digit of production year

m : Production month (See Table.1)

: Production Lot No.

f : The first 4 digits of Frequency including the decimal point

Table.1

Month	Jan	Feb	...	Sep	Oct	Nov	Dec
Code	1	2	...	9	X	Y	Z

■ Reflow profile

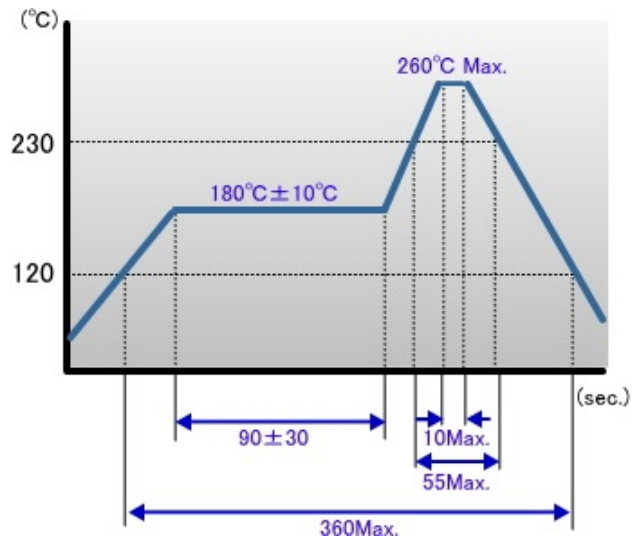

■ Packing

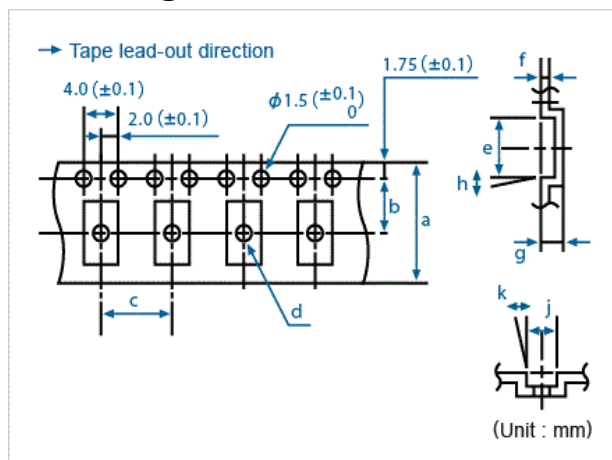

Conforming to JIS C 0806 TB1208NEIAJ and RC-1009B TE1208N

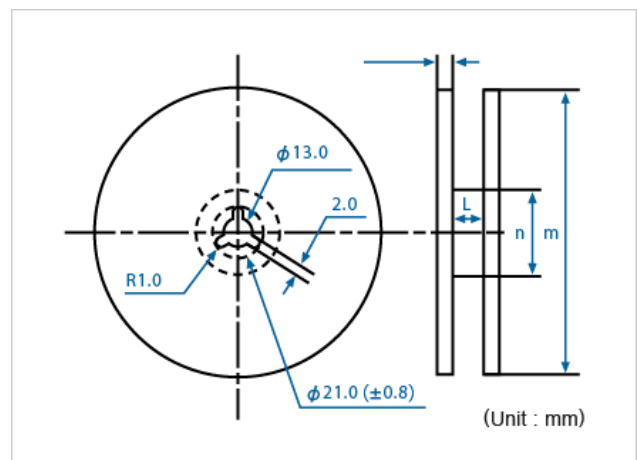

Conforming to JIS C 0806 R12R and EIAJ RC-1009B R15

Q'ty/reel	a	b	c	d (φ)	e	f	g	h	j	k	l	m (φ)	n (φ)
3,000	8.0	3.5	4.0	1.1	3.5	0.25	0.75	5°	2.8	-	11.4	180	60

Rev.1

Mouser Electronics

Authorized Distributor

Click to View Pricing, Inventory, Delivery & Lifecycle Information:

Citizen:

[CS325S-25.000MABJ-UT](#) [CS325S-26.000MABJ-UT](#) [CS325S-24.500MABJ-UT](#) [CS325S-19200000ABJT](#) [CS325S-32000000ABJT](#) [CS325S-24576000ABJT](#) [CS325S-24000000ABJT](#) [CS325S-44000000ABJT](#) [CS325S-33333300ABJT](#) [CS325S-13000000ABJT](#) [CS325S-16000000ABJT](#) [CS325S-14318180ABJT](#) [CS325S-30000000ABJT](#) [CS325S-25000000ABJT](#) [CS325S-16384000ABJT](#) [CS325S-53125000ABJT](#) [CS325S-48000000ABJT](#) [CS325S-33000000ABJT](#) [CS325S-18432000ABJT](#) [CS325S-40000000ABJT](#) [CS325S-28636300ABJT](#) [CS325S-27000000ABJT](#) [CS325S-12000000ABJT](#) [CS325S-13560000ABJT](#) [CS325S33333300ABJT](#) [CS325S40000000ABJT](#) [CS325S44000000ABJT](#) [CS325S48000000ABJT](#) [CS325S53125000ABJT](#) [CS325S12000000ABJT](#) [CS325S27000000ABJT](#) [CS325S28636300ABJT](#) [CS325S30000000ABJT](#) [CS325S32000000ABJT](#) [CS325S33000000ABJT](#) [CS325S19200000ABJT](#) [CS325S24000000ABJT](#) [CS325S24500000ABJT](#) [CS325S24576000ABJT](#) [CS325S25000000ABJT](#) [CS325S26000000ABJT](#) [CS325S13000000ABJT](#) [CS325S13560000ABJT](#) [CS325S14318180ABJT](#) [CS325S16000000ABJT](#) [CS325S16384000ABJT](#) [CS325S18432000ABJT](#)