



Features

- Wide range of available, fixed output voltage.
- Low cost.
- Internal short-circuit current limiting.
- Internal thermal overload protection.
- No external components required.

Pin Configuration

SOP-8(SOIC-8)

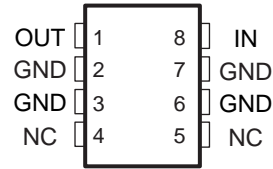

Applications

- Three-terminal positive voltage regulator.

Absolute Maximum Ratings

Symbol	Parameter	Value	Units
V_I	Input voltage	30	V
I_{CM}	Maximum output current	100	mA
P_D	Power dissipation	500	mW
T_{OPR}	Operating junction temperature	0 to +125	°C
T_j, T_{stg}	Storage temperature range	-40 to +150	°C

Typical Application

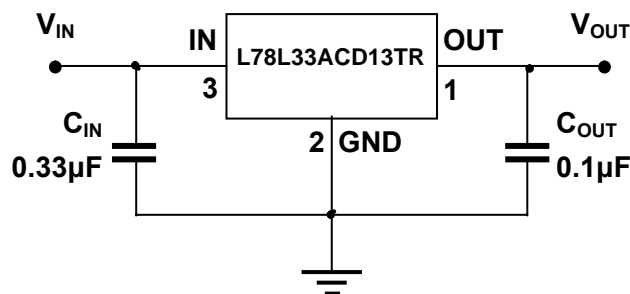

Conventional Circuit



Electrical Characteristics

($V_{IN}=10V, I_O=40mA, 0^{\circ}C < T_J < 125^{\circ}C, C_I=0.33\mu F, C_O=0.1\mu F$, unless otherwise specified)

Parameter	Symbol	Test conditions	MIN	TYP	MAX	UNIT
Output voltage	V_O	$T_J=25^{\circ}C$ $5.3V \leq V_i \leq 20V, I_O=1mA-40mA$ $V_i=8.3V, I_O=1mA-70mA$	3.168 3.135 3.135	3.3	3.432 3.465 3.465	V
Load regulation	Reg_{load}	$T_J=25^{\circ}C, I_O=1mA-100mA$ $T_J=25^{\circ}C, I_O=1mA-40mA$			60 30	mV
Line regulation	Reg_{line}	$5.3V \leq V_i \leq 20V, T_J=25^{\circ}C$ $6.3V \leq V_i \leq 20V, T_J=25^{\circ}C$			150 100	mV
Input Bias Current	I_{IB}	$T_J=25^{\circ}C$ $T_J=125^{\circ}C$			6.0 5.5	mA
Input Bias Current Change	ΔI_{IB}	$6.3V \leq V_i \leq 20V$ $1mA \leq I_O \leq 40mA$			1.5 0.1	mA
Output noise voltage	V_N	$10Hz \leq f \leq 100KHz$		40		μV
Ripple rejection	RR	$I_O=40mA, 6.3V \leq V_i \leq 16.3V$ $f=120Hz, T_J=25^{\circ}C$	41	49		dB
Dropout voltage	V_I-V_O	$T_J=25^{\circ}C$		1.7		V



Typical Characteristics @ $T_a=25^\circ\text{C}$ unless otherwise specified

Figure 1. Dropout Characteristics

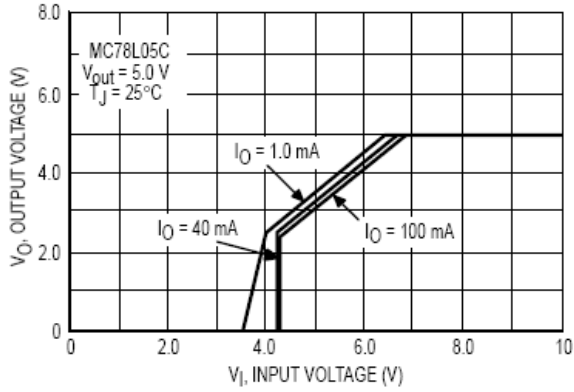

Figure 2. Dropout Voltage versus Junction Temperature

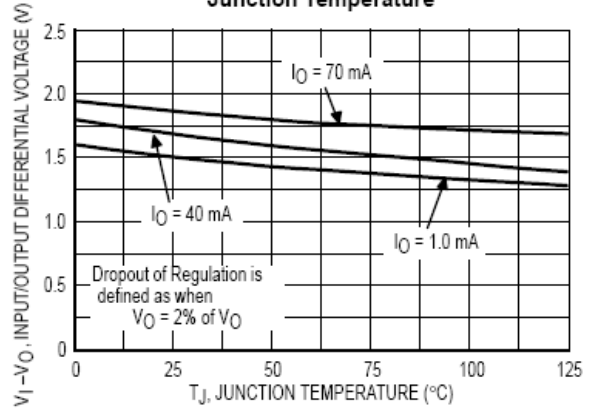

Figure 3. Input Bias Current versus Ambient Temperature

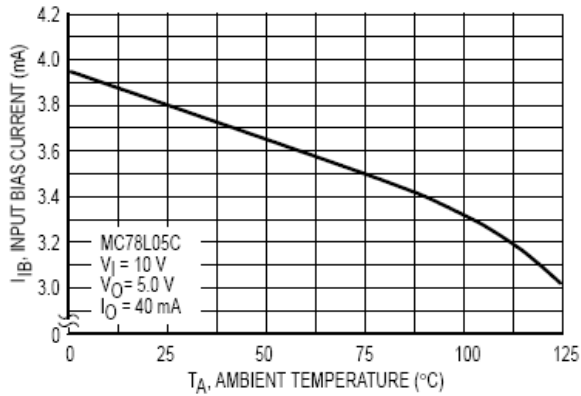
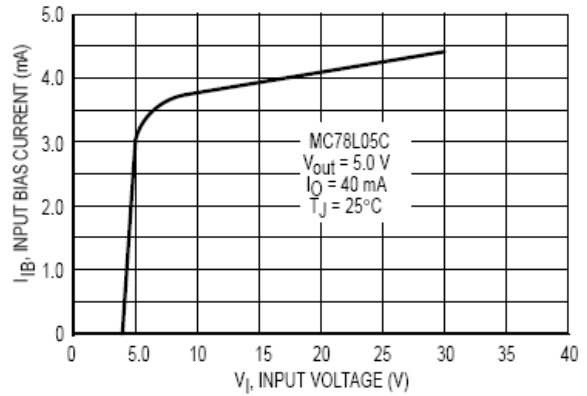
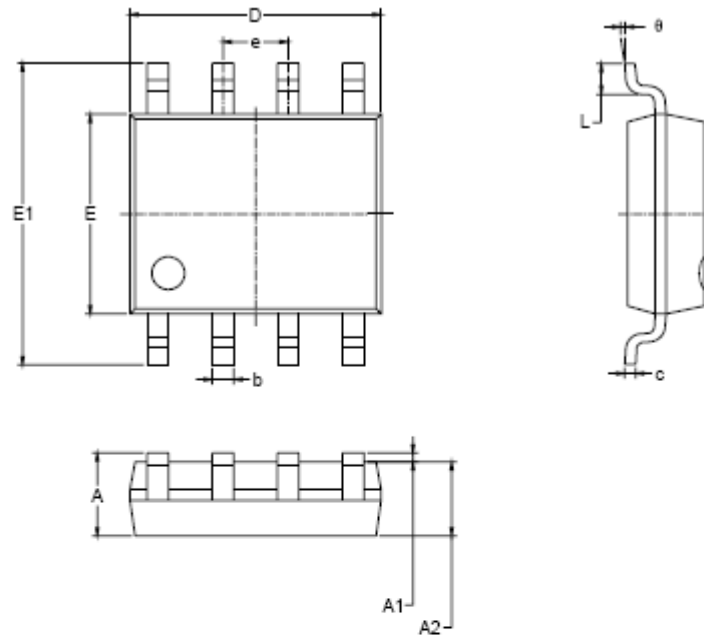

Figure 4. Input Bias Current versus Input Voltage





SOP-8(SOIC-8) Package Information



Symbol	Dimensions In Millimeters		Dimensions In Inches	
	MIN	MAX	MIN	MAX
A	1.350	1.750	0.053	0.069
A1	0.100	0.250	0.004	0.010
A2	1.350	1.550	0.053	0.061
b	0.330	0.510	0.013	0.020
c	0.170	0.250	0.008	0.010
D	4.700	5.100	0.185	0.200
E	3.800	4.000	0.150	0.157
E1	5.800	6.200	0.228	0.244
e	1.27 BSC		0.050 BSC	
L	0.400	1.270	0.016	0.050
θ	0°	8°	0°	8°



Attention

- Any and all HUA XUAN YANG ELECTRONICS products described or contained herein do not have specifications that can handle applications that require extremely high levels of reliability, such as life-support systems, aircraft's control systems, or other applications whose failure can be reasonably expected to result in serious physical and/or material damage. Consult with your HUA XUAN YANG ELECTRONICS representative nearest you before using any HUA XUAN YANG ELECTRONICS products described or contained herein in such applications.
- HUA XUAN YANG ELECTRONICS assumes no responsibility for equipment failures that result from using products at values that exceed, even momentarily, rated values (such as maximum ratings, operating condition ranges, or other parameters) listed in products specifications of any and all HUA XUAN YANG ELECTRONICS products described or contained herein.
- Specifications of any and all HUA XUAN YANG ELECTRONICS products described or contained herein stipulate the performance, characteristics, and functions of the described products in the independent state, and are not guarantees of the performance, characteristics, and functions of the described products as mounted in the customer's products or equipment. To verify symptoms and states that cannot be evaluated in an independent device, the customer should always evaluate and test devices mounted in the customer's products or equipment.
- HUA XUAN YANG ELECTRONICS CO.,LTD. strives to supply high-quality high-reliability products. However, any and all semiconductor products fail with some probability. It is possible that these probabilistic failures could give rise to accidents or events that could endanger human lives, that could give rise to smoke or fire, or that could cause damage to other property. When designing equipment, adopt safety measures so that these kinds of accidents or events cannot occur. Such measures include but are not limited to protective circuits and error prevention circuits for safe design, redundant design, and structural design.
- In the event that any or all HUA XUAN YANG ELECTRONICS products(including technical data, services) described or contained herein are controlled under any of applicable local export control laws and regulations, such products must not be exported without obtaining the export license from the authorities concerned in accordance with the above law.
- No part of this publication may be reproduced or transmitted in any form or by any means, electronic or mechanical, including photocopying and recording, or any information storage or retrieval system, or otherwise, without the prior written permission of HUA XUAN YANG ELECTRONICS CO.,LTD.
- Information (including circuit diagrams and circuit parameters) herein is for example only ; it is not guaranteed for volume production. HUA XUAN YANG ELECTRONICS believes information herein is accurate and reliable, but no guarantees are made or implied regarding its use or any infringements of intellectual property rights or other rights of third parties.
- Any and all information described or contained herein are subject to change without notice due to product/technology improvement, etc. When designing equipment, refer to the "Delivery Specification" for the HUA XUAN YANG ELECTRONICS product that you intend to use.