



# GDQ100S12B-4P DC-DC Converter

## Technical Manual

Issue 1.0  
Date 2021-01-20

HUAWEI TECHNOLOGIES CO., LTD.



# About This Document

## Purpose

This document describes the GDQ100S12B-4P DC-DC Converter, including its electrical specifications, features, applications, and communication.

The figures provided in this document are for reference only.





## Intended Audience

This document is intended for:

- Sales personnel
- Technical support engineers
- System engineers
- Software engineers
- Hardware engineers

## Symbol Conventions

The symbols that may be found in this document are defined as follows.

Symbol	Description
 <b>DANGER</b>	Indicates a hazard with a high level of risk which, if not avoided, will result in death or serious injury.
 <b>WARNING</b>	Indicates a hazard with a medium level of risk which, if not avoided, could result in death or serious injury.
 <b>CAUTION</b>	Indicates a hazard with a low level of risk which, if not avoided, could result in minor or moderate injury.
<b>NOTICE</b>	Indicates a potentially hazardous situation which, if not avoided, could result in equipment damage, data loss, performance deterioration, or unanticipated results. NOTICE is used to address practices not related to personal injury.
 <b>NOTE</b>	Supplements the important information in the main text. NOTE is used to address information not related to personal injury, equipment damage, and environment deterioration.

## Change History

Changes between document issues are cumulative. The latest document issue contains all the changes made in earlier issues.

### **Issue 1.0 (2021-01-20)**

This issue is the first release.

# Contents

<b>About This Document</b> .....	<b>i</b>
<b>1 Product Overview</b> .....	<b>1</b>
<b>2 Electrical Specifications</b> .....	<b>3</b>
2.1 Absolute Maximum Ratings.....	3
2.2 Input.....	4
2.3 Output.....	4
2.4 Efficiency.....	7
2.5 Protection.....	7
2.6 Dynamic Characteristics.....	9
2.7 Insulation Characteristics.....	10
2.8 Other Characteristics.....	10
<b>3 Characteristic Curves</b> .....	<b>11</b>
<b>4 Typical Waveforms</b> .....	<b>12</b>
4.1 Turn-on/Turn-off.....	13
4.2 Output Voltage Dynamic Response.....	14
4.3 Output Voltage Ripple.....	14
<b>5 Remote On/Off</b> .....	<b>15</b>
<b>6 Protection Characteristics</b> .....	<b>16</b>
<b>7 Parallel Operation</b> .....	<b>17</b>
<b>8 Communication</b> .....	<b>19</b>
8.1 Signal Specifications.....	19
8.2 Data Link Layer Protocol.....	20
8.2.1 PMBus Address.....	20
8.2.2 SCL and SDA.....	21
8.2.3 Data Transmission Mode.....	21
8.3 Network Layer Protocol.....	22
8.3.1 Slave Addressing Method.....	22
8.3.2 Checksum.....	22
8.3.3 Data Transmission.....	22
8.4 Application Layer Protocol.....	22
8.4.1 Data Format.....	22
8.4.2 Commands.....	23
8.4.3 Command Descriptions.....	25

<b>9 Mechanical Overview.....</b>	<b>29</b>
<b>10 Safety.....</b>	<b>31</b>
10.1 EMC Specifications.....	31
10.2 Recommended Fuse.....	32
10.3 Recommended Reverse Polarity Protection Circuit.....	32
10.4 Qualification Testing.....	32
10.5 Thermal Consideration.....	33
10.6 MSL Rating.....	34
10.7 Mechanical Consideration.....	34

# 1 Product Overview



## Product Description

The GDQ100S12B-4P is a new generation isolated DC-DC converter that uses an industry standard quarter-brick structure, featuring high efficiency and power density with low output ripple and noise. It operates from an input voltage range of 36 V to 72 V, and provides the rated output voltage of 12 V as well as the maximum output current of 100 A.

## Features

- Efficiency: 93.5% ( $T_A = 25^\circ\text{C}$ ,  $V_{\text{out}} = 12\text{ V}$ ,  $V_{\text{in}} = 48\text{ V}$ , 50% load)
- Length x Width x Height: 57.9 mm x 40.8 mm x 14.8 mm (2.28 in. x 1.61 in. x 0.58 in.)
- Weight: 0.155 kg
- Input undervoltage protection, auxiliary undervoltage protection, output overcurrent protection (hiccup mode), output short circuit protection (hiccup mode), output undervoltage protection (hiccup mode), and overtemperature protection (self-recovery)
- Remote on/off
- UL certification
- UL 62368-1 compliant
- RoHS6 compliant

### Model Naming Convention

GDQ	100	S	12	B	-	4	P
1	2	3	4	5		6	7

1 — 48 V input, high performance, digital control, standard quarter-brick

2 — Output current: 100 A

3 — Single output

4 — Output voltage: 12 V

5 — With a baseplate

6 — Pin length: 4.8 mm

7 — PMBus

### Applications

- Server
- High-power modules of storage equipment

# 2 Electrical Specifications

## 2.1 Absolute Maximum Ratings

**Table 2-1** Absolute maximum ratings

Parameter	Minimum	Typical	Maximum	Unit	Notes & Conditions
Input voltage transient (100 ms)	-	-	100	V	-
Operating ambient temperature ( $T_A$ )	-25	-	85	°C	1. Monomer: It can be started at -40°C; 2. The operating environment temperature specification under parallel operation conditions is -5°C to +85°C; It can be started at -10°C.
Storage temperature	-55	-	125	°C	-
Operating humidity	5	-	95	% RH	Non-condensing
External voltage applied to ON/OFF	-	-	12	V	-
External voltage applied to PMBus	-	-	3.6	V	-
Altitude	-	-	5000	m	54 kPa

### NOTE

When the input voltage is 75–80 V, the converter must not be damaged. Not all the characteristic parameters should be conform to the specification.



## 2.2 Input

**Table 2-2** Input specifications

Parameter	Minimum	Typical	Maximum	Unit	Notes & Conditions
Operating input voltage	36	48	72	V	-
Maximum input current	-	-	48	A	$V_{in} = 36\text{--}75\text{ V}$ , $I_{out} = I_{onom}$
No-load loss	-	-	15	W	$T_A = 25^\circ\text{C}$ , $V_{in} = 48\text{ V}$ , $V_{out} = 12\text{ V}$
Standby loss	-	-	2	W	$T_A = 25^\circ\text{C}$ , $V_{in} = 48\text{ V}$ , CNT OFF
Input capacitance (see <a href="#">Note</a> )	440	-	-	$\mu\text{F}$	$T_A = -40^\circ\text{C}$ to $+85^\circ\text{C}$ , aluminum electrolytic capacitor
Response to input transient	-	1.5	2	V	$T_A = -25^\circ\text{C}$ to $+85^\circ\text{C}$ , $0.5\text{ V}/\mu\text{s}$ input transient, $36\text{--}75\text{ V}$ at full load

### NOTE

- If  $T_A < -5^\circ\text{C}$ , the ESR of the input of an additional electrolytic capacitor should be less than  $10\ \Omega$ .

## 2.3 Output

**Table 2-3** Output specifications

Parameter	Minimum	Typical	Maximum	Unit	Notes & Conditions
Output voltage setpoint	11.88	12	12.12	V	$T_A = 25^\circ\text{C}$ , $V_{in} = 48\text{ V}$ , $V_{out} = 12\text{ V}$ , $I_{out} = 50\% I_{omax}$

Parameter	Minimum	Typical	Maximum	Unit	Notes & Conditions
Output voltage	11.64	12.00	12.36	V	$T_A = -25^{\circ}\text{C}$ to $+85^{\circ}\text{C}$ , $V_{\text{out}} = 12\text{ V}$ (monomer acceptance)  The specification of output voltage range meets the system requirements.
	7.0	7.6	8.2	V	$T_A = -25^{\circ}\text{C}$ to $+85^{\circ}\text{C}$ , $V_{\text{out}} = 7.6\text{ V}$ (adjusted by PMBus), $I_{\text{out}} = 0\text{--}10\text{ A}$
Output current	0	-	100	A	$V_{\text{out}} = 12\text{ V}$
	0	-	10	A	$V_{\text{out}} = 7.6\text{ V}$
Output power	0	-	1200	W	$V_{\text{out}} = 12\text{ V}$
Line regulation	-0.5	-	0.5	%	-
Load regulation	-3	-	3	%	$T_A = -25^{\circ}\text{C}$ to $+85^{\circ}\text{C}$ , $V_{\text{in}} = 48\text{ V}$
Regulated voltage precision	-3	-	3	%	$T_A = -25^{\circ}\text{C}$ to $+85^{\circ}\text{C}$ , $V_{\text{out}} = 12\text{ V}$
Temperature coefficient	-0.02	-	0.02	%/ $^{\circ}\text{C}$	$T_A = -25^{\circ}\text{C}$ to $+85^{\circ}\text{C}$
External capacitance	1200	-	12000	$\mu\text{F}$	SMD aluminum solid capacitor or chip aluminum capacitor, the ESR should be less than 30 mohm.  Parallel capacity: n (number of parallel modules) x (1200–12000 $\mu\text{F}$ ), the maximum is 44000 $\mu\text{F}$

Parameter	Minimum	Typical	Maximum	Unit	Notes & Conditions
Output voltage ripple and noise (peak to peak)	-	-	500	mV	Oscilloscope bandwidth: 20 MHz Output parallel 2 aluminum solid capacitor 560 $\mu$ F + 60 $\mu$ F ceramic capacitor or an aluminum solid capacitor 1200 $\mu$ F + 60 $\mu$ F ceramic capacitor.
Output voltage adjustment	7.0	-	12.6	V	Adjust the voltage by the PMBus
Output voltage adjustment rate	40	46	52	V/S	Adjust the voltage by the PMBus
Output voltage overshoot	-5	-	5	%	Startup/shutdown, $V_{out} = 12$ V
CNT startup delay time	-	-	120	ms	Time from CNT/ PMBus_CTL startup to output voltage rising to 10%.
CNT shutdown delay time	-	-	40	ms	Time from CNT/ PMBus_CTL shutdown to MOSFET drive shutdown.
Output voltage delay time	-	-	10	ms	From receive command to output voltage change
Output voltage rise time	6	-	30	ms	$V_{out} = 7.6$ V (10%–90%)
	12	-	30	ms	$V_{out} = 12$ V (10%–90%)
Time from 7.6 V to 12 V	80	-	120	ms	The upper system sends the voltage regulation command, and MV6 rises to MV12 time.
Time from 12 V to 7.6 V	-	-	120	ms	$I_{out} = 1$ A; The upper system sends the voltage regulation command, and MV12 drops to MV6 time.
Switching frequency	-	140	-	kHz	-

## 2.4 Efficiency

**Table 2-4** Efficiency specifications

Parameter	Minimum	Typical	Maximum	Unit	Notes & Conditions
100% load	91.5	-	-	%	$T_A = 25^\circ\text{C}$ , $V_{in} = 48\text{ V}$ , $V_{out} = 12\text{ V}$ ; Test after running for half an hour at normal temperature.
50% load	93.5	-	-	%	
20% load	92	-	-	%	
10% load	88	-	-	%	
10 A load	82	-	-	%	
					$T_A = 25^\circ\text{C}$ , $V_{in} = 48\text{ V}$ , $V_{out} = 7.6\text{ V}$ ; Test after running for half an hour at normal temperature.

## 2.5 Protection

**Table 2-5** Input protection

Parameter	Minimum	Typical	Maximum	Unit	Notes & Conditions
Input undervoltage protection startup threshold	32	34	36	V	-
Input undervoltage protection shutdown threshold	30	32	34	V	-
Input undervoltage protection hysteresis	1	2	3	V	-
Auxiliary undervoltage protection startup threshold	24.8	26.9	29	V	-
Auxiliary undervoltage protection shutdown threshold	22	25	28	V	-
Auxiliary undervoltage protection hysteresis	0.8	1.8	2.8	V	-

**Table 2-6** Output protection

Parameter	Minimum	Typical	Maximum	Unit	Notes & Conditions
Output overcurrent protection	110	-	140	% $I_{omax}$	<p>1. Hiccup mode, hiccup period is more than 2s (typical value is 2.5s), and lock can be set in equipment mode;</p> <p>2. The over-current protection of <math>V_{out} = 7.6</math> V point is consistent with <math>V_{out} = 12</math> V.</p>
Output short circuit protection	150	-	-	% $I_{omax}$	<p>Hiccup mode, hiccup period is more than 2s (typical value is 2.5s), and lock can be set in equipment mode;</p> <p>Response time of output short circuit protection is no more than 0.5 ms.</p> <p>The short circuit protection of <math>V_{out} = 7.6</math> V point is consistent with <math>V_{out} = 12</math> V.</p>
Output overvoltage protection	110	-	125	% $V_{oset}$	Hiccup mode, hiccup period is more than 2s (typical value is 2.5s), and lock can be set in equipment mode; $V_{oset} = 12$ V, the protection threshold of MV6 is same as MV12.
	13.2	-	15	V	$V_{out} = 12$ V/7.6 V
Overtemperature protection threshold	100	-	130	°C	<p>Self-recovery</p> <p>The values are obtained by measuring the temperature of the PCB near the temperature sensor.</p>
Overtemperature protection hysteresis	5	-	-	°C	

#### NOTE

The duty hiccup period of the limit can not be output according to the actual voltage.

## 2.6 Dynamic Characteristics

**Table 2-7** Dynamic characteristics

Parameter	Minimum	Typical	Maximum	Unit	Notes & Conditions
Overshoot amplitude	-600	-	600	mV	$T_A = -25^{\circ}\text{C}$ to $+85^{\circ}\text{C}$ , current change rate: 0.3 A/ $\mu\text{s}$ ; $T = 10$ ms, load: 25%-50%-25%, 50%-100%-50% Output parallel an aluminum solid capacitor 1200 $\mu\text{F}$ .
Overshoot recovery time (customized)	-	-	300	$\mu\text{s}$	
Overshoot amplitude	-600	-	600	mV	$T_A = -25^{\circ}\text{C}$ to $+85^{\circ}\text{C}$ , current change rate: 0.5 A/ $\mu\text{s}$ ; $T = 10$ ms, load: 10%-90%-10%, $V_{\text{out}} = 7.6$ V Output parallel an aluminum solid capacitor 1200 $\mu\text{F}$ .
Overshoot recovery time	-	-	300	$\mu\text{s}$	

#### NOTE

Starting requirements:

1. Single module: start normally with full load (CR full load, CC half load (0%, 40%, 70%), voltage drop less than 1 V, load change rate 0.1 A/ $\mu\text{s}$ ) (full range requirement).
2. The parallel machine shall cooperate with the system acceptance to meet the system specification requirements.
3. Support parallel synchronous starting and fault recovery synchronous starting (maximum support of 2 modules synchronous starting, can cooperate with system acceptance).

## 2.7 Insulation Characteristics

**Table 2-8** Insulation characteristics

Parameter	Minimum	Typical	Maximum	Unit	Notes & Conditions
Input to output insulation voltage	-	-	1500	V	Functional insulation (1-minute test) , without arc or breakdown; the leakage current should be less than 1 mA.
Input to baseplate insulation voltage	-	-	750	V	
Output to baseplate insulation voltage	-	-	750	V	

## 2.8 Other Characteristics

**Table 2-9** Other characteristics

Parameter	Minimum	Typical	Maximum	Unit	Notes & Conditions
Remote On/Off voltage low level	-0.7	-	1.2	V	Negative logic
Remote On/Off voltage high level	3.5	-	12	V	
On/Off current low level	-	-	1	mA	-
On/Off current high level	-	-	-	μA	
PMBus_CTL voltage low level	0	-	0.8	V	High level effective
PMBus_CTL voltage high level	2.1	-	3.3	V	
PMBus_CTL current low level	-	-	1	mA	-
Mean time between failures (MTBF)	-	2.5	-	Million hours	Telcordia, SR332 Method 1 Case 3; 80% load, normal Input/ rated output; T <sub>A</sub> = 40°C, 300 LFM

# 3 Characteristic Curves

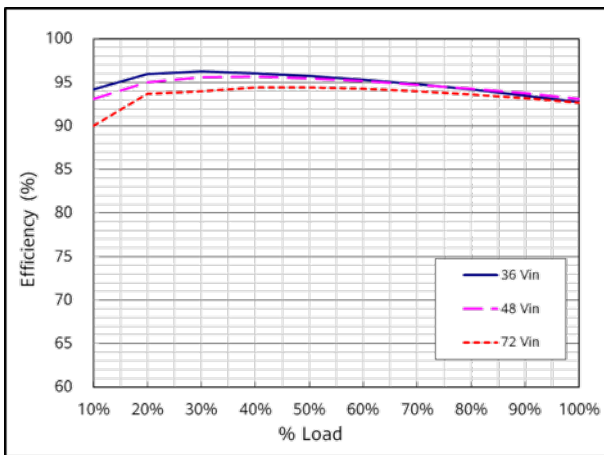

Efficiency curve

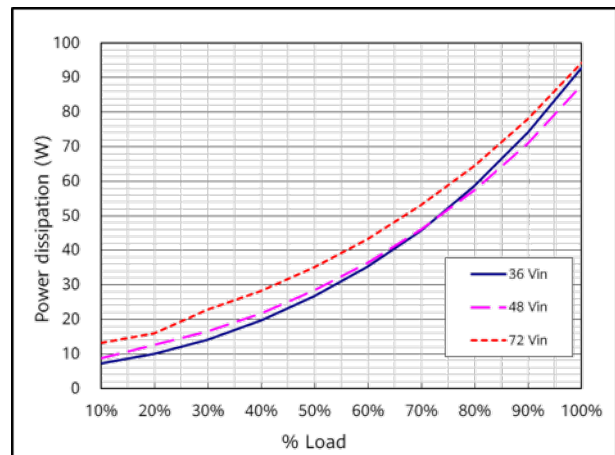

Power dissipation curve



# 4 Typical Waveforms

### NOTE

- During the test of input reflected ripple current, the input must be connected to an external input filter (including a 12  $\mu\text{H}$  inductor and a 220  $\mu\text{F}$  electrolytic capacitor), which is not required in other tests.
- Points B and C are for testing the output voltage ripple.

**Figure 4-1** Test set-up diagram

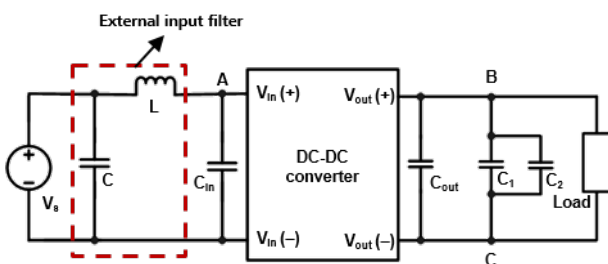

$C_{in}$ : The 440  $\mu\text{F}$  aluminum electrolytic capacitor is recommended.

$C_{out}$ : The 1200  $\mu\text{F}$  SMD aluminum solid capacitor or chip aluminum capacitor is recommended (ESR < 30 m $\Omega$ ).

$C_1$ : The 0.1  $\mu\text{F}$  ceramic capacitor is recommended.

$C_2$ : The 10  $\mu\text{F}$  aluminum electrolytic capacitor is recommended.

**Figure 4-2** Typical circuit applications

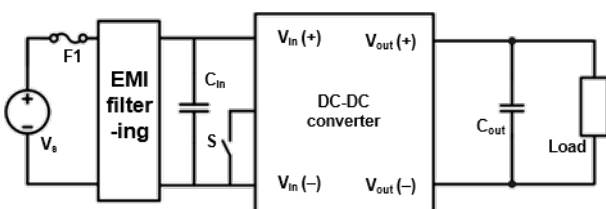

$F_1$ : The 50 A fuse (fast-blow)

$C_{in}$ : The 440  $\mu\text{F}$  aluminum electrolytic capacitor is recommended.

$C_{out}$ : The 1200  $\mu\text{F}$  SMD aluminum solid capacitor or chip aluminum capacitor is recommended (ESR < 30 m $\Omega$ ).

## 4.1 Turn-on/Turn-off

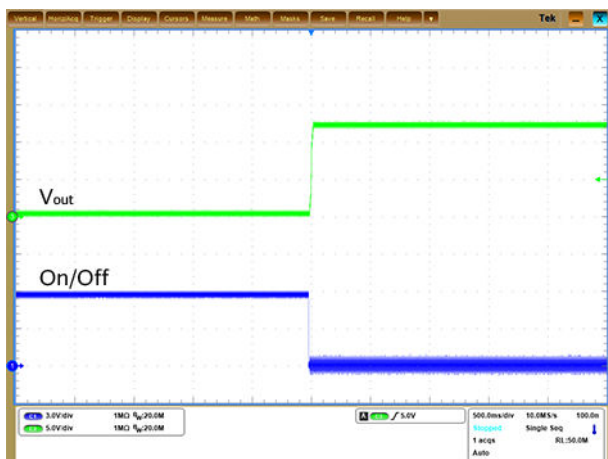

Startup from On/Off

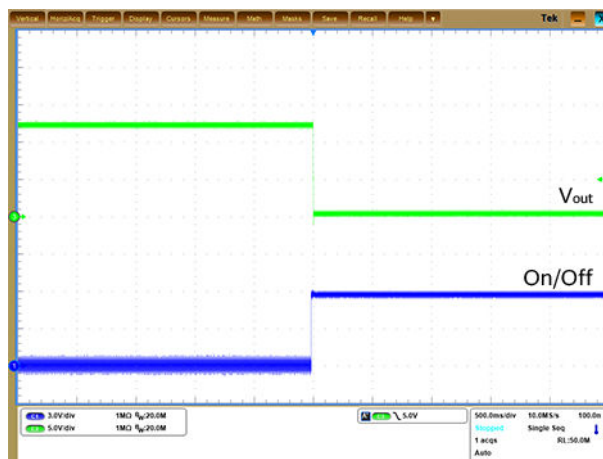

Shutdown from On/Off

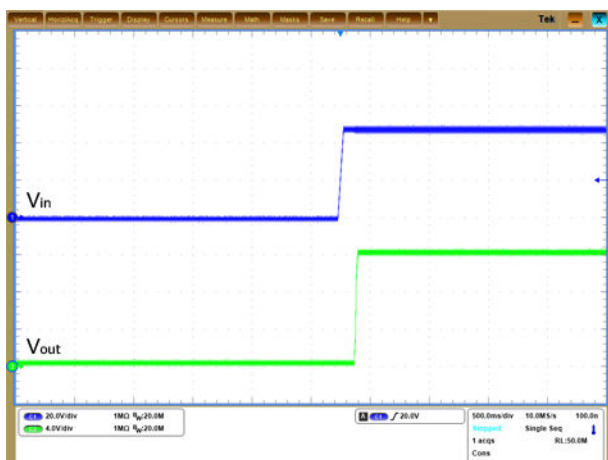

Startup by power-on

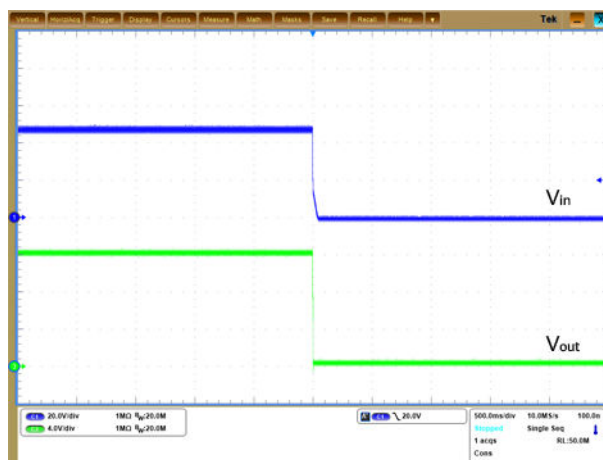

Shutdown by power-off

## 4.2 Output Voltage Dynamic Response

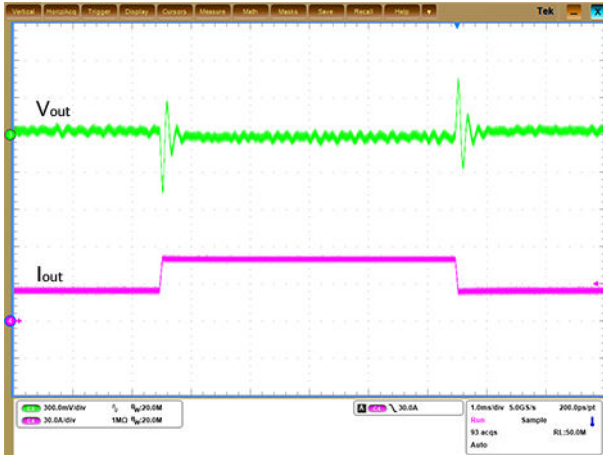

Load: 25%–50%–25%,  $di/dt = 0.3 \text{ A}/\mu\text{s}$

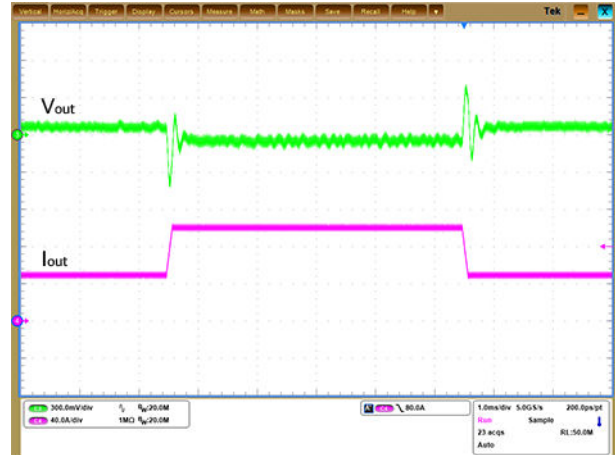

Load: 50%–100%–50%,  $di/dt = 0.3 \text{ A}/\mu\text{s}$

## 4.3 Output Voltage Ripple

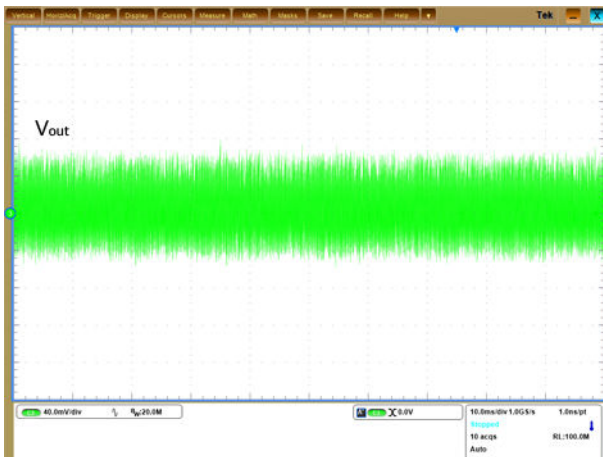

$V_{in} = 48 \text{ V}$ ,  $V_{out} = 12 \text{ V}$ ,  $I_{out} = 100 \text{ A}$

# 5 Remote On/Off

The main output of module can be turned on or turned off by On/Off signal.

On/Off Pin Level	Status
Low level [-0.7 V, 1.2 V]	On
High level [3.5 V, 12.0 V]	Off

**Figure 5-1** Various circuits for driving the On/Off pin

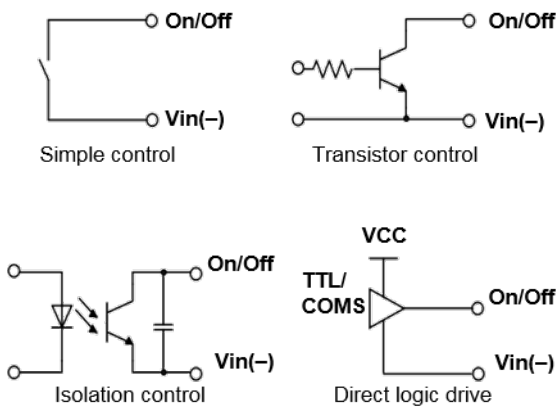

# 6 Protection Characteristics

---

- **Input Undervoltage Protection**

The converter will shut down after the input voltage drops below the undervoltage protection threshold. The converter will start to work again after the input voltage reaches the input undervoltage recovery threshold. For the hysteresis, see [Table 2-5](#).

- **Output Overvoltage Protection**

When the output voltage exceeds the output overvoltage protection threshold, the converter will enter hiccup mode. When the fault condition is removed, the converter will automatically restart.

- **Output Overcurrent Protection**

The converter equipped with current limiting circuitry can provide protection from an output overload or short circuit condition. If the output current exceeds the output overcurrent protection setpoint, the converter enters hiccup mode. When the fault condition is removed, the converter will automatically restart.

- **Overtemperature Protection**

A temperature sensor on the converter senses the average temperature of the converter. It protects the converter from being damaged at high temperatures. When the temperature exceeds the overtemperature protection threshold, the output will shut down. It will allow the converter to turn on again when the temperature of the sensed location falls by the value of the overtemperature protection hysteresis.

# 7 Parallel Operation

- All of the SYNC pins should connect to each other together, but when some module is disabled, its SYNC should be isolated.
- All of the ISHARE pins should connect to each other together.
- Max parallel number is 12 (two module constitute a PSU, and the maximum number of parallel units of PSU is 6).
- The parallel machine shall cooperate with the system acceptance to meet the system specification requirements.
- Current sharing mode: active current sharing method (average current sharing method) is adopted.
- Linear current sharing is required.

**Figure 7-1** Parallel connection

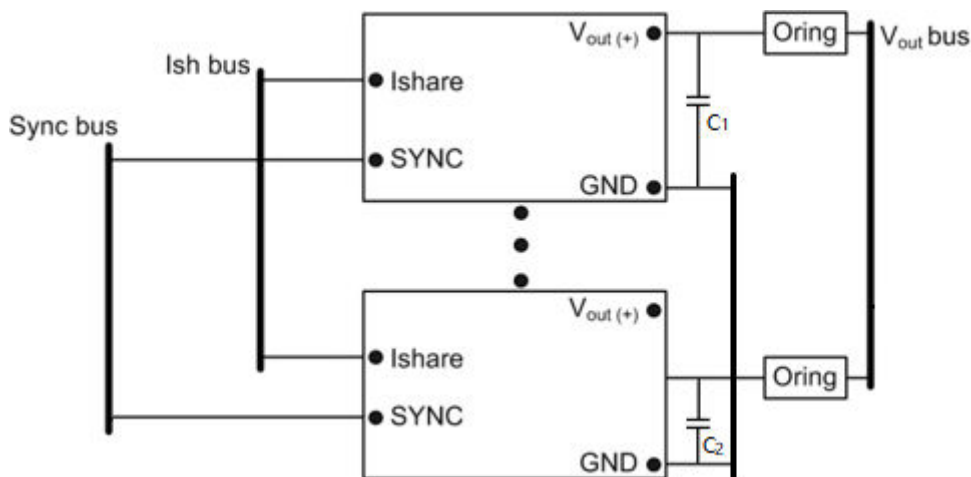

**Table 7-1** Parallel characteristics

Parameter	Minimum	Typical	Maximum	Unit	Notes & Conditions
Unbalance of current equalization	-5	-	5	%	$I_{load} = 20\text{--}100\text{ A}$ (test base on rated current of single module)
Maximum parallel start load	-	-	600	W	CC mode, single module
	-	-	1200	W	CR mode, single module

Parameter	Minimum	Typical	Maximum	Unit	Notes & Conditions
Output ripple and noise	-	300	500	mV	$T_A = -25^{\circ}\text{C}$ to $+85^{\circ}\text{C}$ ; Oscilloscope bandwidth: 20 MHz Output (after the ORing MOSFET/Diodes) parallel 8 aluminum solid capacitor 100 $\mu\text{F}$ +60 $\mu\text{F}$ ceramic capacitor or an aluminum solid capacitor 1200 $\mu\text{F}$ + 60 $\mu\text{F}$ ceramic capacitor.
Bus voltage of current sharing	1.934 x (1%–7%)	-	1.934 x (1% +7%)	V	$I_{\text{load}} = 100 \text{ A}$
	-	-	0.1	V	$I_{\text{load}} = 0 \text{ A}$
Linear current sharing requirements	-5	-	5	%	$I_{\text{load}} = 20\text{--}100 \text{ A}$
Proportional current sharing requirements	1	-	1.5	-	-

# 8 Communication

## 8.1 Signal Specifications

**Table 8-1** PMBus signal interface characteristics

Parameter	Minimum	Typical	Maximum	Unit	Notes & Conditions
Logic input low ( $V_{IL}$ )	-	-	0.8	V	-
Logic input high ( $V_{IH}$ )	2.1	-	3.6	V	-
Logic output low ( $V_{OL}$ )	-	-	0.25	V	$I_{OL} = 6 \text{ mA}$
Logic output high ( $V_{OH}$ )	0.6	-	3.6	V	$I_{OH} = -6 \text{ mA}$
PMBus setting-up time	250	-	-	ns	For details about the values of $t_{set}$ and $t_{hold}$ , see <a href="#">8.2.3 Data Transmission Mode</a> .
PMBus holding time	300	-	-	ns	

**Table 8-2** PMBus detection precision

Parameter	Minimum	Typical	Maximum	Unit	Notes & Conditions
Input voltage detection precision	-2	-	2	V	-
Output voltage detection precision	-0.2	-	0.2	V	-
Output current detection precision	-4	-	4	A	$T_A = 25^\circ\text{C}$ to $+85^\circ\text{C}$ , reported current resolution is no more than 0.2 A.
Temperature detection precision	-5	-	5	$^\circ\text{C}$	$T_A = -25^\circ\text{C}$ to $+85^\circ\text{C}$



Parameter	Minimum	Typical	Maximum	Unit	Notes & Conditions
Output power detected precision	-30	-	30	W	T <sub>A</sub> = 25°C to +85°C, output power is less than 300 W.
	-10% P <sub>o</sub>	-	10% P <sub>o</sub>	W	T <sub>A</sub> = 25°C to +85°C, output power is between 300–600 W.
	-5% P <sub>o</sub>	-	5% P <sub>o</sub>	W	T <sub>A</sub> = 25°C to +85°C, output power is between 600–1200 W
	-	-	50	W	Full load range, T <sub>A</sub> = 25°C to +85°C

## 8.2 Data Link Layer Protocol

The link layer uses the PMBus V1.2 protocol and complies with *PMBus\_Specification\_Part\_I\_Rev\_1-2\_20100906* and *PMBus\_Specification\_Part\_II\_Rev\_1-2\_20100906*.

### 8.2.1 PMBus Address

The following table describes the mapping between the SA0, SA1 and PMBus address. When the SA0 and SA1 left open, PMBus address is 0X5B. When the SA0 and SA1 connect to GND, PMBus address is 0, which is prohibition of use. The PMBus address can be calculated as D:

$$D = 12 \times SA1 + SA0$$

D is the corresponding decimal number of PMBus address data.

R <sub>SA1</sub> (kΩ)	SA1 (V)	SA1 Address (DEC)
0–0.33	0–0.6	0
Left open	2.2–3.3	7

R <sub>ADR</sub> (kΩ)	Pin Voltage (V)	Address	PMBus address
1–15	0–0.165	0	0x54
22	0.198–0.242	1	0x55
30	0.270–0.330	2	0x56
51	0.459–0.561	3	0x57

$R_{ADR}$ (k $\Omega$ )	Pin Voltage (V)	Address	PMBus address
80.6	0.725–0.887	4	0x58
113	1.017–1.243	5	0x59
150	1.350–1.650	6	0x5A
> 220 (Left open)	1.980–2.500	7	0x5B

#### NOTE

1% accuracy is recommended for  $R_{SA0}$  and  $R_{SA1}$  resistors.

## 8.2.2 SCL and SDA

The SCL and SDA are each connected to a pull-up resistor and connected to the communication bus through the fault isolation circuit.

**Figure 8-1** Interconnect diagram of SCL and SDA

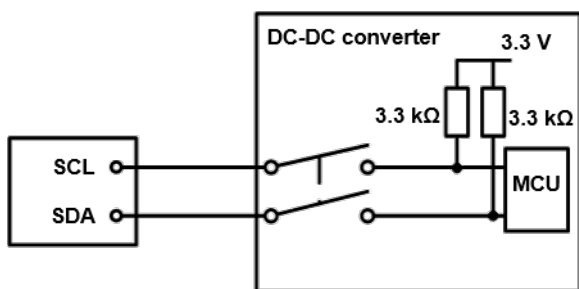

## 8.2.3 Data Transmission Mode

The converter supports both 100 kHz (default) and 400 kHz clock rates.  $T_{set}$  is the duration for which SDA keeps its value unchanged before SCL increases.  $T_{hold}$  is the duration for which SDA keeps its value unchanged after SCL decreases. Communication will fail if the time is not consistent with the specifications.

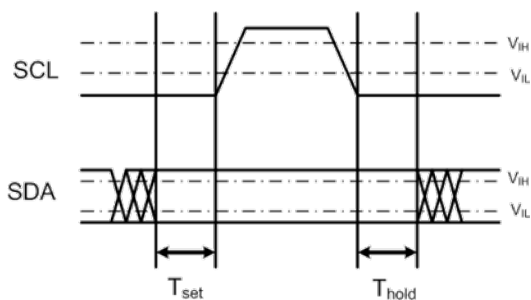

## 8.3 Network Layer Protocol

### 8.3.1 Slave Addressing Method

The converter serves as the slave device, and the converter address is identified by the hardware and assigned in static mode. The master device accesses slave devices independently based on the slave device addresses determined by the hardware.

### 8.3.2 Checksum

To ensure data integrity and accuracy during communication, the converter uses the 8-bit CRC checksum mechanism.

The last byte sent for each communication is the CRC checksum for the communication data. For example, the last byte of the data returned by the converter is the checksum.

The CRC checksum is generated using the multinomial: CRC8.

### 8.3.3 Data Transmission

The converter complies with standard PMBus communication data formats. The data in each PMBus communication data format carries the CRC checksum.

## 8.4 Application Layer Protocol

### 8.4.1 Data Format

#### Linear 11 Data Format

The linear data format is a two-byte value with a 11-bit binary signed mantissa (two's complement) and a 5-bit binary signed exponent (two's complement), as shown in the following figure.

**Figure 8-2** Linear 11 data format

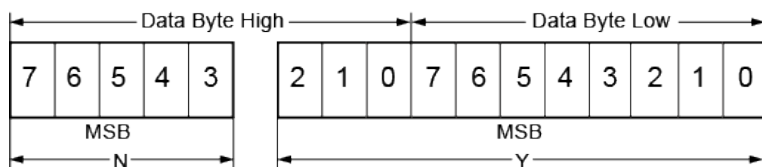

The relationship between  $N$ ,  $Y$ , and actual value  $X$  is given by the following equation:

$$X = Y \times 2^N$$

Where:

- Y is the 11-bit, binary signed mantissa (two's complement).
- N is the 5-bit, binary signed exponent (two's complement).

### Linear 16 Data Format

The linear data format consists of two parts, with a 16-bit binary unsigned mantissa and a 5-bit binary signed exponent (two's complement), as shown in the following figure.

**Figure 8-3** Linear 16 data format

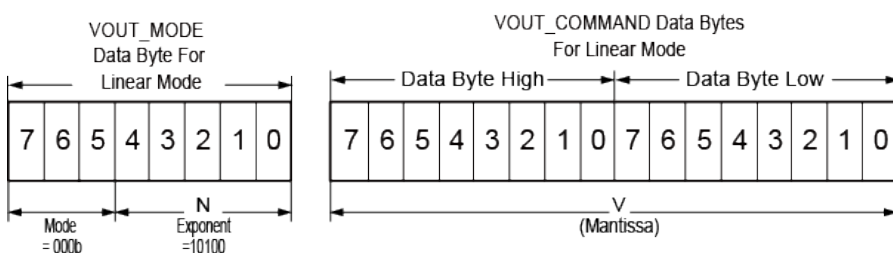

The output voltage is calculated as follows:

$$\text{Voltage} = V \times 2^N$$

Where:

- Voltage is the output voltage value.
- V is the 16-bit unsigned integer.
- N is the 5-bit signed integer (two's complement).

### 8.4.2 Commands

Hex Code	Command Name	Data Type	Data Format
0x01	OPERATION	Read/Write Byte	-
0x03	CLEAR_FAULTS	Send Byte	-
0x11	STORE_DEFAULT_ALL	Send Byte	-
0x20	VOUT_MODE	Read Byte	Q10
0x21	VOUT_COMMAND	Read/Write Word	Linear 16
0x40	VOUT_OV_FAULT_LIMIT	Read/Write Word	Linear 16
0x42	VOUT_OV_WARNING_LIMIT	Read/Write Word	Linear 16
0x46	IOUT_OC_FAULT_LIMIT	Read/Write Word	Linear 11 Q3
0x4A	IOUT_OC_WARNING_LIMIT	Read/Write Word	Linear 11 Q3
0x4F	OT_FAULT_LIMIT	Read/Write Word	Linear 11 Q3

Hex Code	Command Name	Data Type	Data Format
0x51	OT_WARNNING_LIMIT	Read/Write Word	Linear 11 Q3
0x59	VIN_UV_FAULT_LIMIT	Read/Write Word	Linear 11 Q3
0x58	VIN_UV_WARNNING_LIMIT	Read/Write Word	Linear 11 Q3
0x78	STATUS_BYTE	Read Byte	-
0x79	STATUS_WORD	Read Word	-
0x7A	STATUS_VOUT	Read Byte	-
0x7B	STATUS_IOUT	Read Byte	-
0x7C	STATUS_INPUT	Read Byte	-
0x7D	STATUS_TEMPERATURE	Read Byte	-
0x7E	STATUS_CML	Read Byte	-
0x88	READ_VIN	Read Word	Linear 11 Q3
0x8B	READ_VOUT	Read Word	Linear 16 Q10
0x8C	READ_IOUT	Read Word	Linear 11 Q3
0x8D	READ_TEMPERATURE	Read Word	Linear 11 Q2
0x95	READ_FREQUENCY	Read Word	Linear 11 Q0
0x96	READ_POUT	Read Word	Linear 11 Q0
0x60	TON_DELAY	Read/Write Word	Linear 11 Q0
0xD1	SOFT_VERSION	Read Word	-
0xF6	PCB_VERSION	Read Word	-
0x98	PMBUS_VERSION	Read Byte	-
0x99	MFR_ID	Read Block	ASCII
0x9A	MFR_MODEL	Read Block	ASCII
0x9B	MFR_REVISION	Read Block	ASCII
0x9C	MFR_LOCATION	Read Block	ASCII
0x9D	MFR_DATE	Read Block	ASCII
0xD0	PROTOCOL_TYPE	Read Word	-
0xFA	PMBUS_READ_BARCODE_HEADER	Read/Write Block	-
0xFB	PMBUS_BARCODE	Read/Write Block	-

Hex Code	Command Name	Data Type	Data Format
0xF8	SOFTLOAD_INFO	Read Block	ASCII
0xFC	SOFTLOAD_CTRL	Read/Write Word	Unsigned
0xFD	MFR_DEVICE_ID	Write Block	-
0xEA	WRITE_BBOX_FRAME_ID	Read/Write Word	Unsigned
0xEB	READ_BBOX_FRAME_DATA	Read Block	Unsigned
0xEF	READ_BBOX_FRAME_NUM	Read Word	Unsigned

### 8.4.3 Command Descriptions

#### OPERATION (0x01)

Powers on or off the converter or clears the latch-off state.

Function	Data Byte
Start converter	0x80
Reset converter	0x00

#### CLEAR\_FAULTS (0x03)

Clear error history fault information.

#### STORE\_DEFAULT\_ALL (0x11)

Save data after data calibration. If this command is not sent, the data will be lost after a power failure.

#### VOUT\_MODE (0x20)

This command is used to determine the data type and parameters using PMBus command.

#### VOUT\_COMMAND (0x21)

Changes the output voltage of the converter. The default value is 12 V. Voltage adjustment range: 7.0 V to 12.6 V.

### STATUS\_WORD (0x79)

Bit No.	Command Name
Bit 15	VOUT_FAULT_OR_WARNING
Bit 14	IOUT_POUT_FAULT_OR_WARNING
Bit 13	VIN_OR_IIN_FAULT_OR_WARNING
Bit 12	MFR_SPECIFIC_FAULT_OR_WARNING
Bit 11	POWER_GOOD_NOT
Bit 10	FAN_FAULT (unused)
Bit 9	RESERVED1 (unused)
Bit 8	UNKNOWN_FAULT (unused)
Bit 7	BUSY_STATUS (unused)
Bit 6	OFF_STATUS
Bit 5	VOUT_OV_FAULT
Bit 4	IOUT_OC_FAULT
Bit 3	VIN_UV_FAULT
Bit 2	TEMPERATURE_FAULT_OR_WARNING
Bit 1	CML_FAULT
Bit 0	MORE_FAULT_IN_HIGH

### STATUS\_VOUT (0x7A)

Bit No.	Command Name
Bit 7	OV_FAULT
Bit 6	OV_WARN
Bit 5	UV_WARN (unused)
Bit 4	UV_FAULT (unused)
Bit 3	VOUT_MAX_WARN (unused)
Bit 2	TON_MAX_FAULT (unused)
Bit 1	TOFF_MAX_WARN (unused)
Bit 0	VOUT Tracking Error (unused)

### STATUS\_IOUT (0x7B)

Bit No.	Command Name
Bit 7	OC_FAULT
Bit 6	OC_LV_FAULT (unused)
Bit 5	OC_WARN
Bit 4	UC_FAULT (unused)
Bit 3	Current Share Fault (unused)
Bit 2	In Power Limiting Mode (unused)
Bit 1	OP_FAULT (unused)
Bit 0	OP_WARNING (unused)

### STATUS\_INPUT (0x7C)

Bit No.	Command Name
Bit 7	OV_FAULT (unused)
Bit 6	OV_WARN
Bit 5	UV_WARN
Bit 4	UV_FAULT
Bit 3	Unit Off For Low Input Voltage (unused)
Bit 2	OC_FAULT (unused)
Bit 1	OC_WARN (unused)
Bit 0	OP_WARN (unused)

### STATUS\_TEMPERATURE (0x7D)

Bit No.	Command Name
Bit 7	OT_FAULT
Bit 6	OT_WARNING
Bit 5	UT_WARNING (unused)
Bit 4	UT_FAULT (unused)



Bit No.	Command Name
Bit 3	Reserved
Bit 2	Reserved
Bit 1	Reserved
Bit 0	Reserved

### STATUS\_CML (0x7E)

Bit No.	Command Name
Bit 7	INVALID_CMD
Bit 6	INVALID_DATA
Bit 5	PEC_FAILED
Bit 4	MEMORY_FAULT
Bit 3	PROC_FAULT
Bit 2	Reserved
Bit 1	COMM_OTHER_FAULT
Bit 0	OTHER_FAULT

# 9 Mechanical Overview

Figure 9-1 Mechanical overview

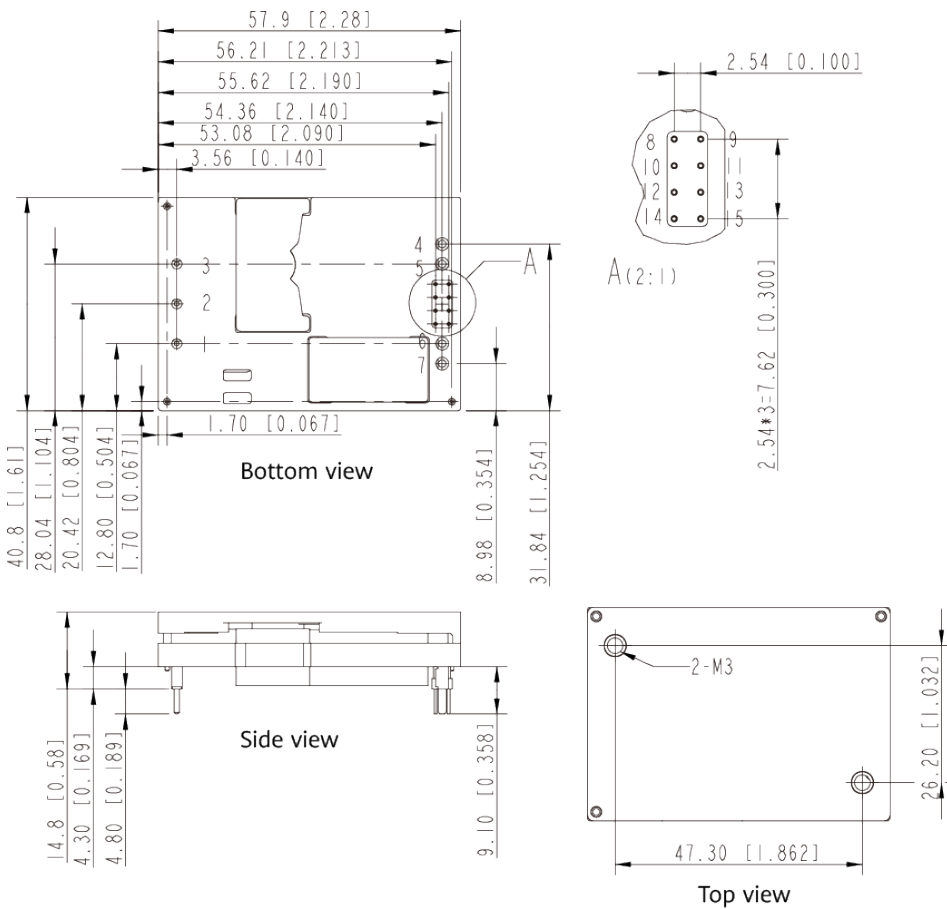

Table 9-1 Pin description

Pin No.	Pin name	Pin No.	Pin name
1	V <sub>in</sub> (+)	9	SA0
2	ON/OFF	10	SYNC/PMBus_ALT
3	V <sub>in</sub> (-)	11	SA1
4	V <sub>out</sub> (-)	12	PMBus_CTL

Pin No.	Pin name	Pin No.	Pin name
5	V <sub>out</sub> (-)	13	ISHARE
6	V <sub>out</sub> (+)	14	PMBus_SCL
7	V <sub>out</sub> (+)	15	PMBus_SDA
8	GND	-	-

#### NOTE

1. All dimensions in mm [in.]  
Tolerances:  $x.x \pm 0.5$  mm [ $x.xx \pm 0.02$  in.];  $x.xx \pm 0.25$  mm [ $x.xxx \pm 0.010$  in.].
2. Pins 1–3 are  $1.00 \pm 0.05$  mm [ $0.040 \pm 0.002$  in.] diameter with  $2.00 \pm 0.10$  mm [ $0.080 \pm 0.004$  in.] diameter standoff shoulders. Pins 4–7 are  $1.50 \pm 0.05$  mm [ $0.060 \pm 0.002$  in.] diameter with  $2.50 \pm 0.10$  mm [ $0.098 \pm 0.004$  in.] diameter standoff shoulders. Pins 8–15 are  $0.50 \pm 0.05$  mm [ $0.020 \pm 0.002$  in.] diameter standoff shoulders.
3. M3 screw used to bolt unit is baseplate to other surfaces (such as heats ink) must not exceed 4.0 mm [0.157 in.] depth below the surface of baseplate.
4. Components will vary between models.

# 10 Safety

## 10.1 EMC Specifications

Figure 10-1 EMC test set-up diagram

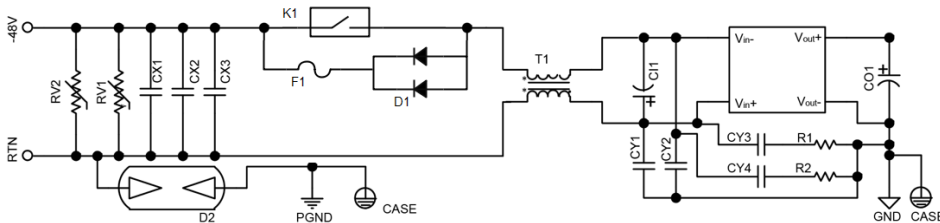

RV1, RV2: Varistor, 100 V, 4500 A

CI1: Aluminum electrolytic capacitor, 100 V, 470  $\mu$ F

CX1, CX2, CX3: Metalized film capacitor, 1  $\mu$ F, 275 V

CY3, CY4: Chip multilayer ceramic capacitor, 22 nF, 1000 V

T1: Common mode inductor, single phase, 400  $\mu$ H

D2: Gas discharge tube, 90 V, 10 kA

CO1: SMD aluminum solid capacitor 660  $\mu$ F

CY1, CY2: Metalized film capacitor, 0.1  $\mu$ F, 275 V

R1, R2: Chip thick film resistor, 1 W, 1  $\Omega$

Table 10-1 EMC

Items	Conditions	Criterion
Conducted emission (CE)	DC Input	EN 55032, class A
ESD	Level 3	IEC/EN 61000-4-2, criterion B
EFT	Level 3	IEC/EN 61000-4-4, criterion B
Surges	common mode 4 kV/ differential mode 2 kV	IEC/EN 61000-4-5, criterion B

Items	Conditions	Criterion
Conducted disturbances immunity	Level 2	IEC/EN 61000-4-6, criterion A
DC voltage dips, short interruption, variation	-	IEC 61000-4-29, criterion B
RE	FCC Part 15 B	EN 55032, criterion A
RS	-	EN 300386, criterion A
Power frequency magnetic field	-	Criterion A

### NOTE

This is a class A product. In residential areas, this product may cause radio interference. Therefore, users may be required to take appropriate measures.

## 10.2 Recommended Fuse

The converter has no internal fuse. To meet safety and regulatory requirements, a 50 A fuse is recommended.

## 10.3 Recommended Reverse Polarity Protection Circuit

### Recommended Reverse Polarity Protection Circuit

Reverse polarity protection is recommended under installation and cabling conditions where reverse polarity across the input may occur.

Figure 10-2 Recommended reverse polarity protection circuit

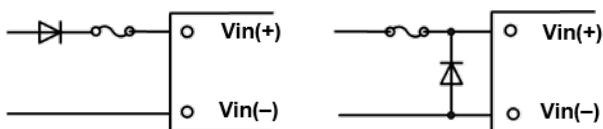

## 10.4 Qualification Testing

Parameter	Units	Condition
Highly accelerated life test (HALT)	6	Low temperature limit: -60°C; high temperature limit: 110°C; vibration limit: 40 G; temp change rate: 40°C/min; vibration freq range: 10 Hz to 10000 Hz; axes of vibration: X/Y/Z

Parameter	Units	Condition
Thermal shock	6	Temperature slope: 20°C/min; 500 cycles; lasting for 30 minutes both at -40°C and +125°C
Thermal humidity bias (THB)	16	Maximum input voltage; 85°C; 85% RH; 1000 operating hours under lowest load power
High temperature operation bias (HTOB)	16	Rated input voltage; air flow: 0.5 m/s (100 LFM) to 5 m/s (1000 LFM); ambient temperature between +45°C and +55°C; 1000 operating hours; 50% to 80% load
Power and temperature cycling test (PTC)	32	Rated input voltage; air flow: 0.5 m/s (100 LFM) to 5 m/s (1000 LFM); ambient temperature between -40°C and +85°C; 1000 cycles; 50% load

## 10.5 Thermal Consideration

### Thermal Test Point

Decide proper airflow to be provided by measuring the temperature of the PCB near the thermal resistor shown in [Figure 10-3](#) to protect the converter against overtemperature. The overtemperature protection threshold is also obtained based on this thermal test point.

**Figure 10-3** Thermal test point

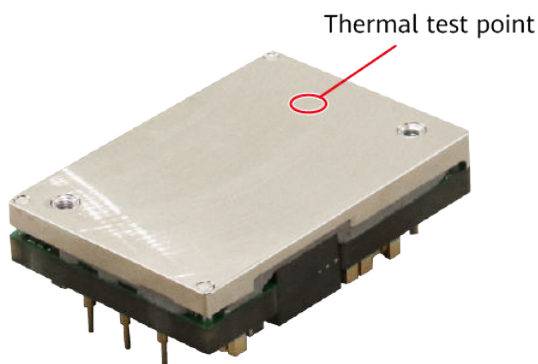

### Power Dissipation

The converter power dissipation is calculated based on efficiency. The following formula reflects the relationship between the consumed power ( $P_d$ ), efficiency ( $\eta$ ), and output power ( $P_o$ ):  $P_d = P_o(1-\eta)/\eta$ .

## 10.6 MSL Rating

### MSL Rating

Store and transport the converter as required by the moisture sensitivity level (MSL) rating 1 specified in the J-STD-020D/033C. The surface of a soldered converter must be clean and dry. Otherwise, the assembly, test, or even reliability of the converter will be negatively affected.

## 10.7 Mechanical Consideration

### Mechanical Consideration

#### Installation

Although the converter can be mounted in any direction, free airflow must be available.

#### Soldering

The converter supports standard wave soldering and hand soldering.

- For wave soldering, the temperature on body is specified to maximum 260°C.
- For hand soldering, the iron temperature should be maintained at 350°C to 420°C and applied to the converter pins for less than 10 seconds.

The converter can be rinsed using the isopropyl alcohol (IPA) solvent or other proper solvents.



**Copyright © Huawei Technologies Co., Ltd. 2021. All rights reserved.**

No part of this document may be reproduced or transmitted in any form or by any means without prior written consent of Huawei Technologies Co., Ltd.

### **Trademarks and Permissions**



HUAWEI and other Huawei trademarks are trademarks of Huawei Technologies Co., Ltd.

All other trademarks and trade names mentioned in this document are the property of their respective holders.

### **Notice**

The purchased products, services and features are stipulated by the contract made between Huawei and the customer. All or part of the products, services and features described in this document may not be within the purchase scope or the usage scope. Unless otherwise specified in the contract, all statements, information, and recommendations in this document are provided "AS IS" without warranties, guarantees or representations of any kind, either express or implied.

The information in this document is subject to change without notice. Every effort has been made in the preparation of this document to ensure accuracy of the contents, but all statements, information, and recommendations in this document do not constitute a warranty of any kind, express or implied.

**Huawei Technologies Co., Ltd.**

Huawei Industrial Base  
Bantian, Longgang  
Shenzhen 518129  
People's Republic of China

**[www.huawei.com](http://www.huawei.com)**