

NOTES:

1. LIGHT PIPE AND ADAPTER SHIPPED UNASSEMBLED.
2. MATERIAL:
 * LIGHT PIPE - SILICONE.
 * ADAPTER - NYLON 6/6, 94V-0, BLACK.
3. SEE PAGE 2, TABLE 2 FOR ADAPTER UTILIZATION.

REVISIONS			
REV.	DESCRIPTION	DATE	APPROVED
A	ENGINEERING RELEASE	12/15/2023	A.V.

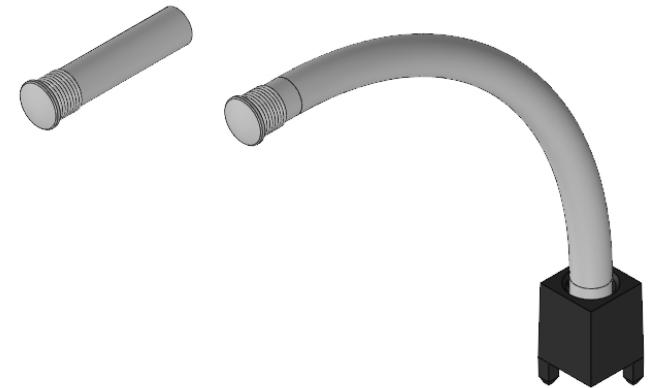
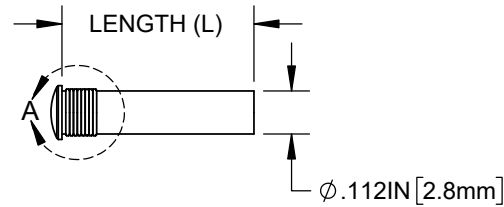
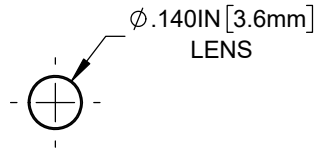

**SILICONE LIGHT PIPE
PART NUMBER CONFIGURATION**

UHF3-X.XXX-X-67

LENGTH (L) — SEE TABLE 1, PAGE 2
 ADAPTER, SEE TABLE 2, PAGE 2
 Y = YES
 N = NO

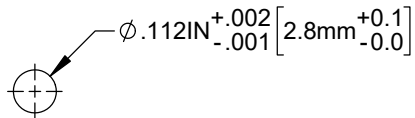
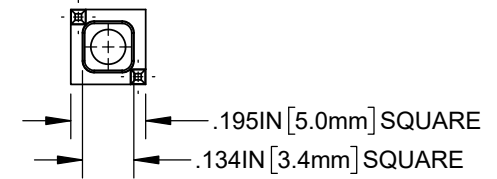
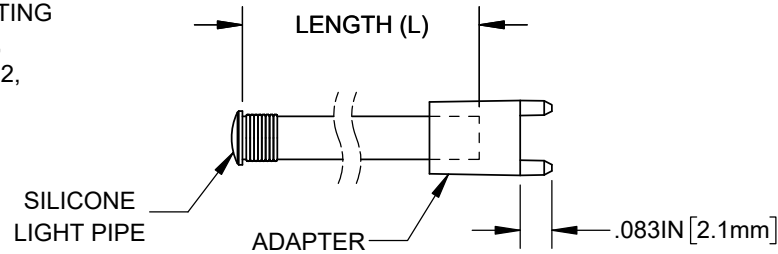

RECOMMENDED LIGHT PIPE MOUNTING HOLE
 PANEL THICKNESS: 0.063" - 0.100"

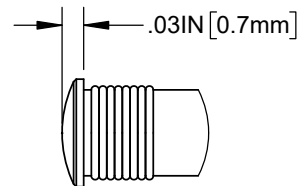

DETAIL A
SCALE 4 : 1

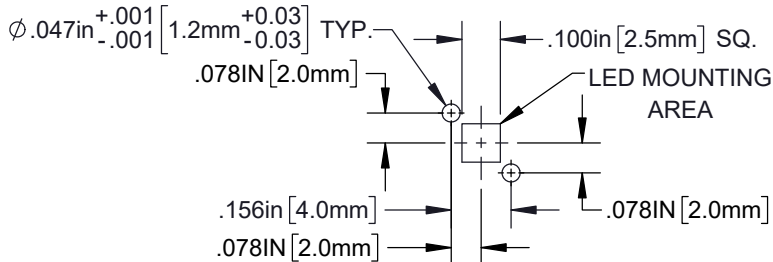

RECOMMENDED ADAPTER MOUNTING HOLES

CUSTOMER USE DRAWING

STANDARD TOLERANCE (UNLESS OTHERWISE SPECIFIED)		 4 THOMAS, IRVINE, CA. 92618 TEL: (949) 951-8808 FAX: (949) 951-3974	
DECIMALS	ANGULAR		
.X ± .1	X° ± 1°	TITLE: IP67 SILICONE LIGHT PIPE	
.XX ± .02		DESIGNED: K. BARON	DATE: 12/15/2023
.XXX ± .010		DRAWING NO: UHF3-X.XXX-X-67	
		REVISION: A	
		REVISER: N/A	DATE:
		CHECKED: A. VALDEZ	DATE: 12/15/2023
SHEET SIZE: A		CAGE CODE: 32559	REVISION: A
SCALE: 2:1		SHEET # 1 OF 2	

TABLE 1 - LENGTH (L)*		
ASSEMBLY PART NUMBER	LENGTH (IN.)	TOLERANCE (IN.)
UHF3-0.250-X-67	.250 [6.4mm]	± 0.005
UHF3-0.500-X-67	.500 [12.7mm]	
UHF3-0.750-X-67	.750 [19.1mm]	
UHF3-1.000-X-67	1.000 [25.4mm]	± 0.010
UHF3-1.250-X-67	1.250 [31.8mm]	
UHF3-1.500-X-67	1.500 [38.1mm]	
UHF3-1.750-X-67	1.750 [44.5mm]	
UHF3-2.000-X-67	2.000 [50.8mm]	
UHF3-2.500-X-67	2.500 [63.5mm]	± 0.050
UHF3-3.000-X-67	3.000 [76.2mm]	
UHF3-3.500-X-67	3.500 [88.9mm]	
UHF3-4.000-X-67	4.000 [101.6mm]	
UHF3-4.500-X-67	4.500 [114.3mm]	
UHF3-5.000-X-67	5.000 [127.0mm]	
UHF3-5.500-X-67	5.500 [139.7mm]	
UHF3-6.000-X-67	6.000 [152.4mm]	
		± 0.100

* CUSTOM LENGTHS WITHIN .100" [2.5mm] AND 6.000" [152.4mm] INCLUDING mm LENGTHS, AVAILABLE UPON REQUEST.

TABLE 2 - ADAPTER AVAILABILITY (Y/N)		
LENGTH (IN.)	ADAPTER	
.250	-	N
.500	Y	N
.750	Y	-
1.000	Y	-
1.250	Y	-
1.500	Y	-
1.750	Y	-
2.000	Y	-
2.500	Y	-
3.000	Y	-
3.500	Y	-
4.000	Y	-
4.500	Y	-
5.000	Y	-
5.500	Y	-
6.000	Y	-

SAMPLE PART NUMBERS

UHF3-0.500-X-N-67

UHF3-1.500-X-Y-67

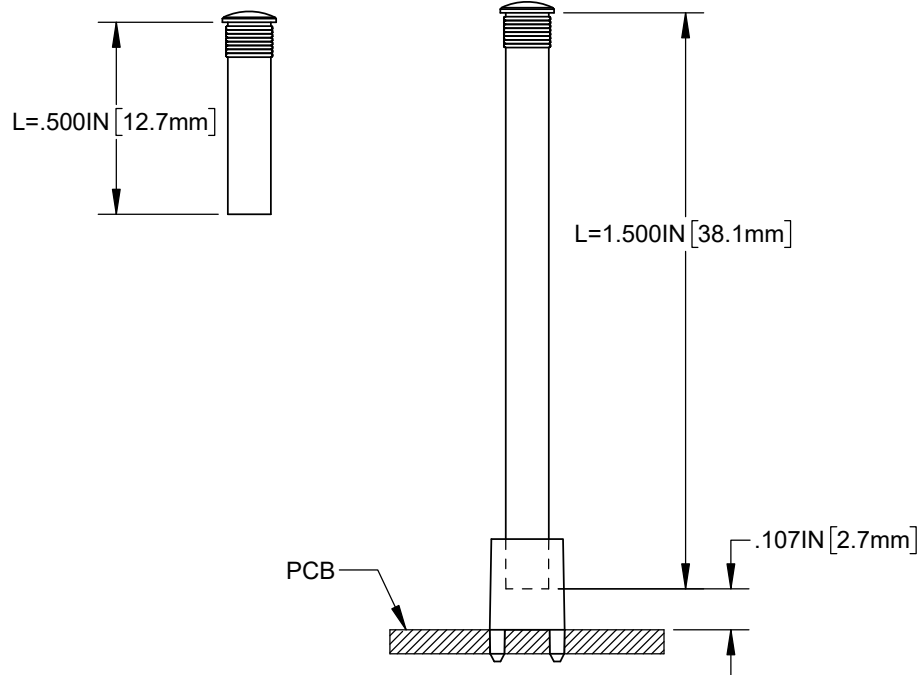

MINIMUM BEND RADIUS:
10X LIGHT PIPE DIAMETER

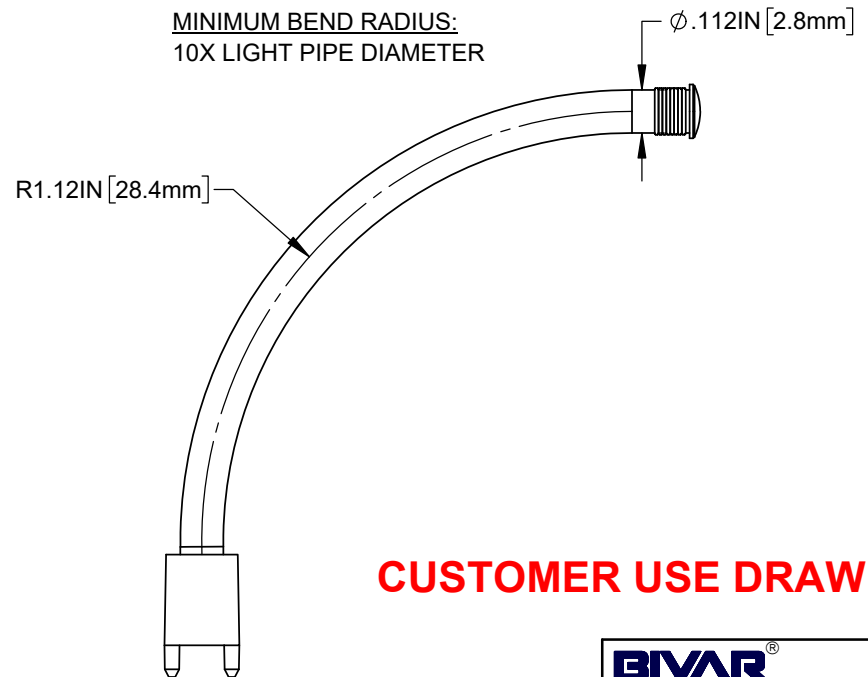

CUSTOMER USE DRAWING

		BIVAR [®]	
CAGE CODE:	32559	DRAWING NO:	UHF3-X.XXX-X-67
		REVISION:	A
SHEET SIZE:	A	SCALE:	2:1
		SHEET # 2 OF 2	
<small>CAD GENERATED DOCUMENT, DO NOT MEASURE DRAWING</small>			