

## TPS25940x-Q1 2.7-V to 18-V eFuse with Integrated Short-to-Battery Protection

### 1 Features

- Qualified for Automotive Applications
- AEC-Q100 Qualified With the Following Results:
  - Device Temperature Grade 1:  $-40^{\circ}\text{C}$  to  $+125^{\circ}\text{C}$  Ambient Operating Temperature Range
  - Device HBM ESD Classification Level 2
  - Device CDM ESD Classification Level C5
- 2.7-V to 18-V Operating Voltage, 20 V (Maximum)
- Total  $R_{\text{ON}}$ : 42 m $\Omega$  (Typical)
- 0.6-A to 5.3-A Adjustable Current Limit ( $\pm 8\%$ )
- IMON Current Indicator Output ( $\pm 8\%$ )
- Adjustable Under-, Overvoltage Threshold ( $\pm 2\%$ )
- Reverse Current Blocking
- 1- $\mu\text{s}$  Reverse Voltage Shutoff
- Programmable  $dV_{\text{O}}/dt$  Control
- Power Good and Fault Outputs
- Short-to-Battery Protection
- Short-to-Ground Protection
- TPS25940-Q1: Auto-Retry
- TPS25940L-Q1: Latch-Off

### 2 Applications

- Automotive Infotainment
- ADAS Cameras and Radar Sensors
- USB Hubs
- Power MUXing
- Holdup Power Management

### 3 Description

The TPS25940x-Q1 eFuse Power Switches are compact, feature rich power management devices with a full suite of protection functions. The wide operating range allows control of many popular DC bus voltages. Integrated back-to-back FETs provide bidirectional current control making the device well suited for systems with load side holdup energy that must not drain back to a failed supply bus.

Load, source and device protection are provided with many programmable features including overcurrent,  $dV_{\text{O}}/dt$  ramp and overvoltage, undervoltage thresholds. For system status monitoring and downstream load control, the device provides PGOOD,  $\overline{\text{FLT}}$  and precise current monitor output. Precise programmable undervoltage, overvoltage thresholds and mode simplify power management design.

The TPS25940x-Q1 monitor  $V_{\text{(IN)}}$  and  $V_{\text{(OUT)}}$  to provide true reverse current blocking when  $V_{\text{(IN)}} < (V_{\text{(OUT)}} - 66 \text{ mV})$ . This function supports supply bus protection from over-voltages during output short to battery faults.

#### Device Information<sup>(1)</sup>

| PART NUMBER  | PACKAGE   | BODY SIZE (NOM)   |
|--------------|-----------|-------------------|
| TPS25940-Q1  | WQFN (20) | 3.00 mm x 4.00 mm |
| TPS25940L-Q1 |           |                   |

(1) For all available packages, see the orderable addendum at the end of the data sheet.

#### Simplified Schematic

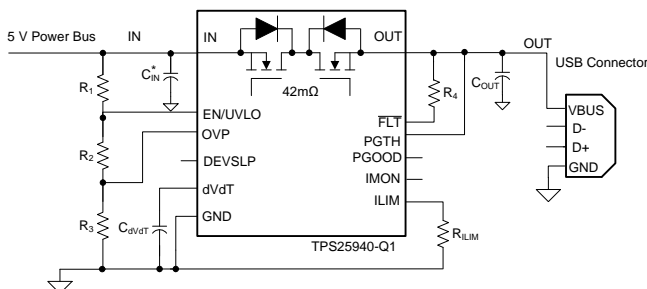

#### Output Short-to-Battery Detection and Protection

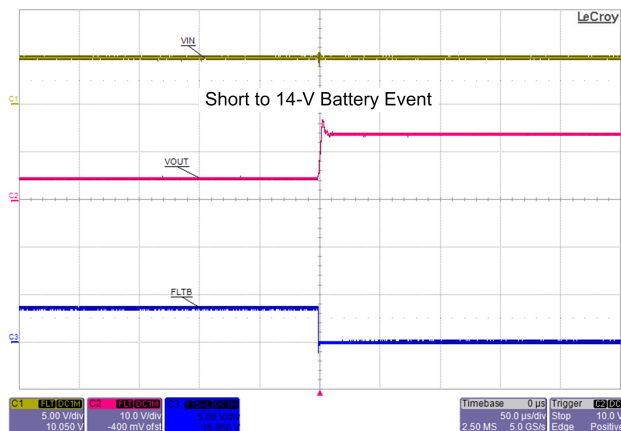

## Table of Contents

|          |                                                 |           |           |                                                               |           |
|----------|-------------------------------------------------|-----------|-----------|---------------------------------------------------------------|-----------|
| <b>1</b> | <b>Features</b> .....                           | <b>1</b>  | 8.4       | Device Functional Modes.....                                  | <b>22</b> |
| <b>2</b> | <b>Applications</b> .....                       | <b>1</b>  | <b>9</b>  | <b>Application and Implementation</b> .....                   | <b>24</b> |
| <b>3</b> | <b>Description</b> .....                        | <b>1</b>  | 9.1       | Application Information.....                                  | <b>24</b> |
| <b>4</b> | <b>Revision History</b> .....                   | <b>2</b>  | 9.2       | Typical Application .....                                     | <b>24</b> |
| <b>5</b> | <b>Pin Configuration and Functions</b> .....    | <b>3</b>  | <b>10</b> | <b>Power Supply Recommendations</b> .....                     | <b>37</b> |
| <b>6</b> | <b>Specifications</b> .....                     | <b>4</b>  | 10.1      | Transient Protection .....                                    | <b>37</b> |
| 6.1      | Absolute Maximum Ratings .....                  | <b>4</b>  | 10.2      | Output Short-Circuit Measurements .....                       | <b>38</b> |
| 6.2      | ESD Ratings .....                               | <b>4</b>  | <b>11</b> | <b>Layout</b> .....                                           | <b>39</b> |
| 6.3      | Recommended Operating Conditions.....           | <b>4</b>  | 11.1      | Layout Guidelines .....                                       | <b>39</b> |
| 6.4      | Thermal Information .....                       | <b>5</b>  | 11.2      | Layout Example .....                                          | <b>40</b> |
| 6.5      | Electrical Characteristics.....                 | <b>5</b>  | <b>12</b> | <b>Device and Documentation Support</b> .....                 | <b>41</b> |
| 6.6      | Timing Requirements .....                       | <b>7</b>  | 12.1      | Documentation Support .....                                   | <b>41</b> |
| 6.7      | Typical Characteristics .....                   | <b>8</b>  | 12.2      | Community Resources.....                                      | <b>41</b> |
| <b>7</b> | <b>Parametric Measurement Information</b> ..... | <b>15</b> | 12.3      | Trademarks .....                                              | <b>41</b> |
| <b>8</b> | <b>Detailed Description</b> .....               | <b>16</b> | 12.4      | Electrostatic Discharge Caution.....                          | <b>41</b> |
| 8.1      | Overview .....                                  | <b>16</b> | 12.5      | Glossary .....                                                | <b>41</b> |
| 8.2      | Functional Block Diagram .....                  | <b>17</b> | <b>13</b> | <b>Mechanical, Packaging, and Orderable Information</b> ..... | <b>41</b> |
| 8.3      | Feature Description.....                        | <b>18</b> |           |                                                               |           |

## 4 Revision History

NOTE: Page numbers for previous revisions may differ from page numbers in the current version.

| <b>Changes from Revision C (July 2018) to Revision D</b>            | <b>Page</b> |
|---------------------------------------------------------------------|-------------|
| • Changed internal ramp rate of 12 V/ms for output to 30 V/ms ..... | <b>19</b>   |

| <b>Changes from Revision B (November 2017) to Revision C</b> | <b>Page</b> |
|--------------------------------------------------------------|-------------|
| • Changed from Production Data to Prod Mixed .....           | <b>1</b>    |
| • Added the latch-off variant (TPS25940L-Q1) .....           | <b>1</b>    |

  

| <b>Changes from Revision A (June 2016) to Revision B</b>                                                            | <b>Page</b> |
|---------------------------------------------------------------------------------------------------------------------|-------------|
| • Added subsection 9.2.4.3 Overload Detection Using TPS25940-Q1 to the <i>Application Information</i> section ..... | <b>1</b>    |

| <b>Changes from Original (May 2016) to Revision A</b>                               | <b>Page</b> |
|-------------------------------------------------------------------------------------|-------------|
| • Changed device status from <i>Product Preview</i> to <i>Production Data</i> ..... | <b>1</b>    |

## 5 Pin Configuration and Functions

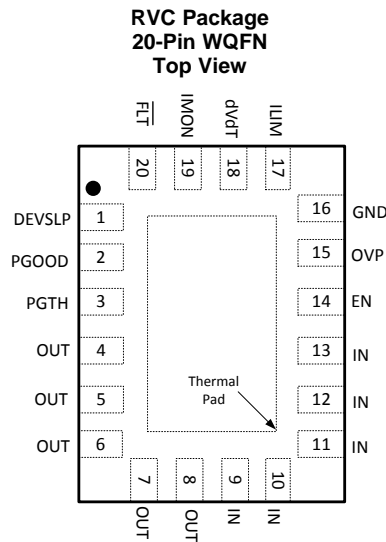

### Pin Functions

| PIN |         | TYPE | DESCRIPTION                                                                                                                                                                                                   |
|-----|---------|------|---------------------------------------------------------------------------------------------------------------------------------------------------------------------------------------------------------------|
| NO. | NAME    |      |                                                                                                                                                                                                               |
| 1   | DEVSLP  | I    | Active high. DevSleep mode control. A high at this pin activates the DevSleep mode (low power mode). If unused, leave floating or connect it to GND                                                           |
| 2   | PGOOD   | O    | Active high. A high indicates PGTH has crossed the threshold value. It is an open drain output. If unused, leave floating                                                                                     |
| 3   | PGTH    | I    | Positive input of PGOOD comparator. If unused connect to OUT or GND                                                                                                                                           |
| 4   | OUT     | O    | Power output of the device                                                                                                                                                                                    |
| 5   |         |      |                                                                                                                                                                                                               |
| 6   |         |      |                                                                                                                                                                                                               |
| 7   |         |      |                                                                                                                                                                                                               |
| 8   | IN      | I    | Power input and supply voltage of the device                                                                                                                                                                  |
| 9   |         |      |                                                                                                                                                                                                               |
| 10  |         |      |                                                                                                                                                                                                               |
| 11  |         |      |                                                                                                                                                                                                               |
| 12  | EN/UVLO | I    | Input for setting programmable undervoltage lockout threshold. An undervoltage event opens internal FET and assert FLT to indicate power-failure                                                              |
| 13  |         |      |                                                                                                                                                                                                               |
| 14  | OVP     | I    | Input for setting programmable overvoltage protection threshold. An overvoltage event opens the internal FET and assert FLT to indicate overvoltage                                                           |
| 15  | GND     | —    | Ground. The GND terminal must be connected to the exposed PowerPAD. This PowerPAD must be connected to a PCB ground plane using multiple vias for good thermal performance                                    |
| 16  | ILIM    | I/O  | A resistor from this pin to GND sets the overload and short-circuit current limit                                                                                                                             |
| 17  | dVdT    | I/O  | A capacitor from this pin to GND sets the ramp rate of output voltage                                                                                                                                         |
| 18  | IMON    | O    | This pin sources a scaled down ratio of current through the internal FET. A resistor from this pin to GND converts current to proportional voltage, used as analog current monitor. If unused, leave floating |
| 19  | FLT     | O    | Fault event indicator, goes low to indicate fault condition because of undervoltage, overvoltage, reverse voltage and thermal shutdown event. It is an open drain output. If unused, leave floating           |
| 20  |         |      |                                                                                                                                                                                                               |

## 6 Specifications

### 6.1 Absolute Maximum Ratings

 over operating free-air temperature range (unless otherwise noted)<sup>(1)</sup>

|                                                                            |                                                                     | MIN                | MAX  | UNIT             |
|----------------------------------------------------------------------------|---------------------------------------------------------------------|--------------------|------|------------------|
| Input voltage                                                              | IN, OUT, PGTH, PGOOD, EN/UVLO, OVP, DEVSLP, $\overline{\text{FLT}}$ | -0.3               | 20   | V                |
|                                                                            | IN, OUT (10 ms transient)                                           |                    | 22   |                  |
|                                                                            | dVdT, ILIM                                                          | -0.3               | 3.6  |                  |
|                                                                            | IMON                                                                | -0.3               | 7    |                  |
| Sink current                                                               | PGOOD, $\overline{\text{FLT}}$ , dVdT                               |                    | 10   | mA               |
| Maximum continuous switch current, $T_A = 85^\circ\text{C}$ <sup>(2)</sup> | $I_{\text{MAX}}$                                                    |                    | 4.78 | A                |
| Source current                                                             | dVdT, ILIM, IMON                                                    | Internally Limited |      |                  |
| Continuous power dissipation                                               | See the <a href="#">Thermal Information</a> table                   |                    |      |                  |
| Maximum junction temperature                                               | $T_J$                                                               | -40                | 150  | $^\circ\text{C}$ |
| Storage temperature                                                        | $T_{\text{stg}}$                                                    | -65                | 150  | $^\circ\text{C}$ |

- (1) Stresses beyond those listed under *Absolute Maximum Ratings* may cause permanent damage to the device. These are stress ratings only, which do not imply functional operation of the device at these or any other conditions beyond those indicated under *Recommended Operating Conditions*. Exposure to absolute-maximum-rated conditions for extended periods may affect device reliability.
- (2) Assumes 15 K power-on-hours at 100% duty cycle. This information is provided solely for your convenience and does not extend or modify the warranty provided under TI's standard terms and conditions for TI's semiconductor products.

### 6.2 ESD Ratings

|                                            |                                                         | VALUE      | UNIT |
|--------------------------------------------|---------------------------------------------------------|------------|------|
| $V_{\text{(ESD)}}$ Electrostatic discharge | Human-body model (HBM), per AEC Q100-002 <sup>(1)</sup> | $\pm 3000$ | V    |
|                                            | Charged-device model (CDM), per AEC Q100-011            | $\pm 1000$ |      |

- (1) AEC Q100-002 indicates that HBM stressing shall be in accordance with the ANSI/ESDA/JEDEC JS-001 specification.

### 6.3 Recommended Operating Conditions

over operating free-air temperature range (unless otherwise noted)

|                                                                 |                                | MIN  | NOM | MAX | UNIT             |
|-----------------------------------------------------------------|--------------------------------|------|-----|-----|------------------|
| IN                                                              | Input voltage                  | 2.7  |     | 18  | V                |
| EN/UVLO, OVP, DEVSLP, OUT, PGTH, PGOOD, $\overline{\text{FLT}}$ |                                | 0    |     | 18  |                  |
| dVdT, ILIM                                                      |                                | 0    |     | 3   |                  |
| IMON                                                            |                                | 0    |     | 6   |                  |
| ILIM                                                            | Resistance                     | 16.9 |     | 150 | k $\Omega$       |
| IMON                                                            |                                | 1    |     |     |                  |
| OUT                                                             | External capacitance           | 0.1  |     |     | $\mu\text{F}$    |
| dVdT                                                            |                                |      |     | 470 | nF               |
| $T_J$                                                           | Operating junction temperature | -40  | 25  | 125 | $^\circ\text{C}$ |

## 6.4 Thermal Information

| THERMAL METRIC <sup>(1)</sup> |                                              | TPS25940x-Q1 |      |
|-------------------------------|----------------------------------------------|--------------|------|
|                               |                                              | RVC (WQFN)   |      |
|                               |                                              | 20 PINS      |      |
|                               |                                              |              | UNIT |
| R <sub>θJA</sub>              | Junction-to-ambient thermal resistance       | 38.1         | °C/W |
| R <sub>θJCTop</sub>           | Junction-to-case (top) thermal resistance    | 40.5         | °C/W |
| R <sub>θJB</sub>              | Junction-to-board thermal resistance         | 13.6         | °C/W |
| ψ <sub>JT</sub>               | Junction-to-top characterization parameter   | 0.6          | °C/W |
| ψ <sub>JB</sub>               | Junction-to-board characterization parameter | 13.7         | °C/W |
| R <sub>θJCbott</sub>          | Junction-to-case (bottom) thermal resistance | 3.4          | °C/W |

(1) For more information about traditional and new thermal metrics, see the [Semiconductor and IC Package Thermal Metrics](#) application report.

## 6.5 Electrical Characteristics

–40°C ≤ T<sub>J</sub> = T<sub>A</sub> ≤ 125°C, 2.7 V ≤ V<sub>(IN)</sub> = 18 V, V<sub>(EN/UVLO)</sub> = 2 V, V<sub>(OVP)</sub> = V<sub>(DEVSLP)</sub> = V<sub>(PGTH)</sub> = 0 V, R<sub>(ILIM)</sub> = 150 kΩ, C<sub>(OUT)</sub> = 1 μF, C<sub>(dVdT)</sub> = OPEN, PGOOD = FLT = IMON = OPEN. Positive current into terminals. All voltages referenced to GND (unless otherwise noted)

| PARAMETER                                               |                                                                          | TEST CONDITIONS                                                | MIN   | TYP  | MAX   | UNIT |
|---------------------------------------------------------|--------------------------------------------------------------------------|----------------------------------------------------------------|-------|------|-------|------|
| <b>SUPPLY VOLTAGE AND INTERNAL UNDERVOLTAGE LOCKOUT</b> |                                                                          |                                                                |       |      |       |      |
| V <sub>(IN)</sub>                                       | Operating input voltage                                                  |                                                                | 2.7   |      | 18    | V    |
| V <sub>(UVR)</sub>                                      | Internal UVLO threshold, rising                                          |                                                                | 2.2   | 2.3  | 2.4   | V    |
| V <sub>(UVRhys)</sub>                                   | Internal UVLO hysteresis                                                 |                                                                | 105   | 116  | 125   | mV   |
| I <sub>Q(ON)</sub>                                      | Supply current, enabled                                                  | V <sub>(EN/UVLO)</sub> = 2 V, V <sub>(IN)</sub> = 3 V          | 140   | 210  | 300   | μA   |
|                                                         |                                                                          | V <sub>(EN/UVLO)</sub> = 2 V, V <sub>(IN)</sub> = 12 V         | 140   | 199  | 260   |      |
|                                                         |                                                                          | V <sub>(EN/UVLO)</sub> = 2 V, V <sub>(IN)</sub> = 18 V         | 140   | 202  | 270   |      |
| I <sub>Q(OFF)</sub>                                     | Supply current, disabled                                                 | V <sub>(EN/UVLO)</sub> = 0 V, V <sub>(IN)</sub> = 3 V          | 4     | 8.6  | 15    | μA   |
|                                                         |                                                                          | V <sub>(EN/UVLO)</sub> = 0 V, V <sub>(IN)</sub> = 12 V         | 6     | 15   | 20    |      |
|                                                         |                                                                          | V <sub>(EN/UVLO)</sub> = 0 V, V <sub>(IN)</sub> = 18 V         | 8     | 18.5 | 25    |      |
| I <sub>Q(DEVSLP)</sub>                                  | Supply current, devSleep mode                                            | V <sub>(DEVSLP)</sub> = 0 V, V <sub>(IN)</sub> = 2.7 V to 18 V | 70    | 95   | 130   | μA   |
| <b>ENABLE AND UNDERVOLTAGE LOCKOUT (EN/UVLO) INPUT</b>  |                                                                          |                                                                |       |      |       |      |
| V <sub>(ENR)</sub>                                      | EN/UVLO threshold voltage, rising                                        |                                                                | 0.97  | 0.99 | 1.01  | V    |
| V <sub>(ENF)</sub>                                      | EN/UVLO threshold voltage, falling                                       |                                                                | 0.9   | 0.92 | 0.94  | V    |
| V <sub>(SHUTF)</sub>                                    | EN threshold voltage for Low I <sub>Q</sub> shutdown, falling            |                                                                | 0.3   | 0.47 | 0.63  | V    |
| V <sub>(SHUTFhys)</sub>                                 | EN hysteresis for low I <sub>Q</sub> shutdown, hysteresis <sup>(1)</sup> |                                                                |       | 66   |       | mV   |
| I <sub>EN</sub>                                         | EN Input leakage current                                                 | 0 V ≤ V <sub>(EN/UVLO)</sub> ≤ 18 V                            | –100  | 0    | 100   | nA   |
| <b>OVER VOLTAGE PROTECTION (OVP) INPUT</b>              |                                                                          |                                                                |       |      |       |      |
| V <sub>(OVPR)</sub>                                     | Overvoltage threshold voltage, rising                                    |                                                                | 0.97  | 0.99 | 1.01  | V    |
| V <sub>(OVPF)</sub>                                     | Overvoltage threshold voltage, falling                                   |                                                                | 0.9   | 0.92 | 0.94  | V    |
| I <sub>(OVP)</sub>                                      | OVP input leakage current                                                | 0 V ≤ V <sub>(OVP)</sub> ≤ 5 V                                 | –100  | 0    | 100   | nA   |
| <b>DEVSLP MODE INPUT (DEVSLP): ACTIVE HIGH</b>          |                                                                          |                                                                |       |      |       |      |
| V <sub>(DEVSLPR)</sub>                                  | DEVSLP threshold voltage, rising                                         |                                                                | 1.6   | 1.85 | 2     | V    |
| V <sub>(DEVSLPF)</sub>                                  | DEVSLP threshold voltage, falling                                        |                                                                | 0.8   | 0.96 | 1.1   | V    |
| I <sub>(DEVSLP)</sub>                                   | DEVSLP input leakage current                                             | 0.2 V ≤ V <sub>(DEVSLP)</sub> ≤ 18 V                           | 0.6   | 1    | 1.25  | μA   |
| <b>OUTPUT RAMP CONTROL (dVdT)</b>                       |                                                                          |                                                                |       |      |       |      |
| I <sub>(dVdT)</sub>                                     | dVdT charging current                                                    | V <sub>(dVdT)</sub> = 0 V                                      | 0.85  | 1    | 1.15  | μA   |
| R <sub>(dVdT)</sub>                                     | dVdT discharging resistance                                              | EN/UVLO = 0 V, I <sub>(dVdT)</sub> = 10 mA sinking             |       | 16   | 24    | Ω    |
| V <sub>(dVdTmax)</sub>                                  | dVdT maximum capacitor voltage                                           |                                                                | 2.6   | 2.88 | 3.1   | V    |
| GAIN <sub>(dVdT)</sub>                                  | dVdT to OUT gain                                                         | ΔV <sub>(OUT)</sub> /ΔV <sub>(dVdT)</sub>                      | 11.65 | 11.9 | 12.05 | V/V  |
| <b>CURRENT LIMIT PROGRAMMING (ILIM)</b>                 |                                                                          |                                                                |       |      |       |      |

(1) These parameters are provided for reference only and do not constitute part of TI's published device specifications for purposes of TI's product warranty.

**Electrical Characteristics (continued)**

$-40^{\circ}\text{C} \leq T_J = T_A \leq 125^{\circ}\text{C}$ ,  $2.7\text{ V} \leq V_{(IN)} = 18\text{ V}$ ,  $V_{(EN/UVLO)} = 2\text{ V}$ ,  $V_{(OVP)} = V_{(DEVSLP)} = V_{(PGTH)} = 0\text{ V}$ ,  $R_{(ILIM)} = 150\text{ k}\Omega$ ,  $C_{(OUT)} = 1\text{ }\mu\text{F}$ ,  $C_{(dVdT)} = \text{OPEN}$ ,  $\text{PGOOD} = \overline{\text{FLT}} = \text{IMON} = \text{OPEN}$ . Positive current into terminals. All voltages referenced to GND (unless otherwise noted)

| PARAMETER                                                          |                                                                             | TEST CONDITIONS                                                                                        | MIN        | TYP                            | MAX   | UNIT                   |
|--------------------------------------------------------------------|-----------------------------------------------------------------------------|--------------------------------------------------------------------------------------------------------|------------|--------------------------------|-------|------------------------|
| $V_{(ILIM)}$                                                       | ILIM bias voltage                                                           |                                                                                                        |            | 0.87                           |       | V                      |
| $I_{(LIM)}$                                                        | Current limit <sup>(2)</sup>                                                | $R_{(ILIM)} = 150\text{ k}\Omega$ , $(V_{(IN)} - V_{(OUT)}) = 1\text{ V}$                              | 0.53       | 0.58                           | 0.63  | A                      |
|                                                                    |                                                                             | $R_{(ILIM)} = 88.7\text{ k}\Omega$ , $(V_{(IN)} - V_{(OUT)}) = 1\text{ V}$                             | 0.9        | 0.99                           | 1.07  |                        |
|                                                                    |                                                                             | $R_{(ILIM)} = 42.2\text{ k}\Omega$ , $(V_{(IN)} - V_{(OUT)}) = 1\text{ V}$                             | 1.92       | 2.08                           | 2.25  |                        |
|                                                                    |                                                                             | $R_{(ILIM)} = 20\text{ k}\Omega$ , $(V_{(IN)} - V_{(OUT)}) = 1\text{ V}$                               | 4.09       | 4.45                           | 4.81  |                        |
|                                                                    |                                                                             | $R_{(ILIM)} = 16.9\text{ k}\Omega$ , $(V_{(IN)} - V_{(OUT)}) = 1\text{ V}$                             | 4.78       | 5.2                            | 5.62  |                        |
|                                                                    |                                                                             | $R_{(ILIM)} = \text{OPEN}$ , Open resistor current limit (single point failure test: UL60950)          | 0.35       | 0.45                           | 0.55  |                        |
|                                                                    |                                                                             | $R_{(ILIM)} = \text{SHORT}$ , Shorted resistor current limit (single point failure test: UL60950)      | 0.55       | 0.67                           | 0.8   |                        |
| $I_{(DEVSLP(LIM))}$                                                | DevSleep mode current limit                                                 |                                                                                                        | 0.55       | 0.67                           | 0.8   | A                      |
| $I_{OS}$                                                           | Short-circuit current limit <sup>(2)</sup>                                  | $R_{(ILIM)} = 42.2\text{ k}\Omega$ , $V_{(VIN)} = 12\text{ V}$ , $(V_{(IN)} - V_{(OUT)}) = 5\text{ V}$ | 1.91       | 2.07                           | 2.24  | A                      |
|                                                                    |                                                                             | $R_{(ILIM)} = 20\text{ k}\Omega$ , $V_{(VIN)} = 12\text{ V}$ , $(V_{(IN)} - V_{(OUT)}) = 5\text{ V}$   | 4          | 4.4                            | 4.7   |                        |
|                                                                    |                                                                             | $R_{(ILIM)} = 16.9\text{ k}\Omega$ , $V_{(VIN)} = 12\text{ V}$ , $(V_{(IN)} - V_{(OUT)}) = 5\text{ V}$ | 4.7        | 5.11                           | 5.52  |                        |
| $I_{(FASTTRIP)}$                                                   | Fast-trip comparator threshold <sup>(1)(2)</sup>                            |                                                                                                        |            | $1.5 \times I_{(LIM)} + 0.375$ |       | A                      |
| <b>CURRENT MONITOR OUTPUT (IMON)</b>                               |                                                                             |                                                                                                        |            |                                |       |                        |
| $\text{GAIN}_{(IMON)}$                                             | Gain factor $I_{(IMON)}:I_{(OUT)}$                                          | $1\text{ A} \leq I_{(OUT)} \leq 5\text{ A}$                                                            | 47.78      | 52.3                           | 57.23 | $\mu\text{A}/\text{A}$ |
| <b>MOSFET – POWER SWITCH</b>                                       |                                                                             |                                                                                                        |            |                                |       |                        |
| $R_{ON}$                                                           | IN to OUT - ON resistance                                                   | $1\text{ A} \leq I_{(OUT)} \leq 5\text{ A}$ , $T_J = 25^{\circ}\text{C}$                               | 34         | 42                             | 49    | m $\Omega$             |
|                                                                    |                                                                             | $1\text{ A} \leq I_{(OUT)} \leq 5\text{ A}$ , $-40^{\circ}\text{C} \leq T_J \leq +85^{\circ}\text{C}$  | 26         | 42                             | 58    |                        |
|                                                                    |                                                                             | $1\text{ A} \leq I_{(OUT)} \leq 5\text{ A}$ , $-40^{\circ}\text{C} \leq T_J \leq +125^{\circ}\text{C}$ | 26         | 42                             | 64    |                        |
| <b>PASS FET OUTPUT (OUT)</b>                                       |                                                                             |                                                                                                        |            |                                |       |                        |
| $I_{(kg)(OUT)}$                                                    | OUT leakage current in off state                                            | $V_{(IN)} = 18\text{ V}$ , $V_{(EN/UVLO)} = 0\text{ V}$ , $V_{(OUT)} = 0\text{ V}$ (sourcing)          | -2         | 0                              | 2     | $\mu\text{A}$          |
|                                                                    |                                                                             | $V_{(IN)} = 2.7\text{ V}$ , $V_{(EN/UVLO)} = 0\text{ V}$ , $V_{(OUT)} = 18\text{ V}$ (sinking)         | 6          | 13                             | 20    |                        |
| $V_{(REVTH)}$                                                      | $V_{(IN)} - V_{(OUT)}$ threshold for reverse protection comparator, falling |                                                                                                        | -77        | -66                            | -55   | mV                     |
| $V_{(FWDTH)}$                                                      | $V_{(IN)} - V_{(OUT)}$ threshold for reverse protection comparator, rising  |                                                                                                        | 86         | 100                            | 114   | mV                     |
| <b>FAULT FLAG (<math>\overline{\text{FLT}}</math>): ACTIVE LOW</b> |                                                                             |                                                                                                        |            |                                |       |                        |
| $R_{(\overline{\text{FLT}})}$                                      | $\overline{\text{FLT}}$ internal pull-down resistance                       | $V_{(OVP)} = 2\text{ V}$ , $I_{(\overline{\text{FLT}})} = 5\text{ mA}$ sinking                         | 10         | 18                             | 30    | $\Omega$               |
| $I_{(\overline{\text{FLT}})}$                                      | $\overline{\text{FLT}}$ input leakage current                               | $0\text{ V} \leq V_{(\overline{\text{FLT}})} \leq 18\text{ V}$                                         | -1         | 0                              | 1     | $\mu\text{A}$          |
| <b>POSITIVE INPUT for POWER-GOOD COMPARATOR (PGTH)</b>             |                                                                             |                                                                                                        |            |                                |       |                        |
| $V_{(PGTHR)}$                                                      | PGTH threshold voltage, rising                                              |                                                                                                        | 0.97       | 0.99                           | 1.01  | V                      |
| $V_{(PGTHF)}$                                                      | PGTH threshold voltage, falling                                             |                                                                                                        | 0.9        | 0.92                           | 0.94  | V                      |
| $I_{(PGTH)}$                                                       | PGTH input leakage current                                                  | $0\text{ V} \leq V_{(PGTH)} \leq 18\text{ V}$                                                          | -100       | 0                              | 100   | nA                     |
| <b>POWER-GOOD COMPARATOR OUTPUT (PGOOD): ACTIVE HIGH</b>           |                                                                             |                                                                                                        |            |                                |       |                        |
| $R_{(PGOOD)}$                                                      | PGOOD internal pull-down resistance                                         | $V_{(PGTH)} = 0\text{ V}$ , $I_{(PGOOD)} = 5\text{ mA}$ sinking                                        | 10         | 20                             | 35    | $\Omega$               |
| $I_{(PGOOD)}$                                                      | PGOOD input leakage current                                                 | $0\text{ V} \leq V_{(PGOOD)} \leq 18\text{ V}$                                                         | -1         | 0                              | 1     | $\mu\text{A}$          |
| <b>THERMAL SHUT DOWN (TSD)</b>                                     |                                                                             |                                                                                                        |            |                                |       |                        |
| $T_{(TSD)}$                                                        | TSD threshold <sup>(1)</sup>                                                |                                                                                                        |            | 160                            |       | $^{\circ}\text{C}$     |
| $T_{(TSDhys)}$                                                     | TSD hysteresis <sup>(1)</sup>                                               |                                                                                                        |            | 12                             |       | $^{\circ}\text{C}$     |
|                                                                    | Thermal fault response                                                      | TPS25940-Q1                                                                                            | Auto-retry |                                |       |                        |
|                                                                    |                                                                             | TPS25940L-Q1                                                                                           | Latch-off  |                                |       |                        |

(2) Pulse-testing techniques maintain junction temperature close to ambient temperature. Thermal effects must be taken into account separately.

## 6.6 Timing Requirements

$-40^{\circ}\text{C} \leq T_J = T_A \leq 125^{\circ}\text{C}$ ,  $2.7\text{ V} \leq V_{(IN)} = 18\text{ V}$ ,  $V_{(EN/UVLO)} = 2\text{ V}$ ,  $V_{(OVP)} = V_{(DEVSLP)} = V_{(PGTH)} = 0\text{ V}$ ,  $R_{(ILIM)} = 150\text{ k}\Omega$ ,  $C_{(OUT)} = 1\text{ }\mu\text{F}$ ,  $C_{(dVdT)} = \text{OPEN}$ ,  $\text{PGOOD} = \overline{\text{FLT}} = \text{IMON} = \text{OPEN}$ . Positive current into terminals. All voltages referenced to GND (unless otherwise noted). See [Figure 42](#) for the timing diagrams.

| PARAMETER                                                |                                     | TEST CONDITIONS                                                                                                                         | MIN  | TYP                           | MAX  | UNIT          |
|----------------------------------------------------------|-------------------------------------|-----------------------------------------------------------------------------------------------------------------------------------------|------|-------------------------------|------|---------------|
| <b>ENABLE and UVLO INPUT</b>                             |                                     |                                                                                                                                         |      |                               |      |               |
| $t_{\text{ON(dly)}}$                                     | EN turnon delay                     | EN/UVLO $\uparrow$ (100 mV above $V_{(ENR)}$ ) to $V_{(OUT)} = 100\text{ mV}$ , $C_{(dVdT)} < 0.8\text{ nF}$                            |      | 220                           |      | $\mu\text{s}$ |
|                                                          |                                     | EN/UVLO $\uparrow$ (100 mV above $V_{(ENR)}$ ) to $V_{(OUT)} = 100\text{ mV}$ , $C_{(dVdT)} \geq 0.8\text{ nF}$ , [ $C_{(dVdT)}$ in nF] |      | $100 + 150 \times C_{(dVdT)}$ |      | $\mu\text{s}$ |
| $t_{\text{OFF(dly)}}$                                    | EN turnoff delay                    | EN/UVLO $\downarrow$ (100 mV below $V_{(ENF)}$ ) to $\overline{\text{FLT}}\downarrow$                                                   |      | 2                             |      | $\mu\text{s}$ |
| <b>OVERVOLTAGE PROTECTION INPUT (OVP)</b>                |                                     |                                                                                                                                         |      |                               |      |               |
| $t_{\text{OVP(dly)}}$                                    | OVP disable delay                   | OVP $\uparrow$ (100 mV above $V_{(OVPR)}$ ) to $\overline{\text{FLT}}\downarrow$                                                        |      | 2                             |      | $\mu\text{s}$ |
| <b>OUTPUT RAMP CONTROL (dV/dT)</b>                       |                                     |                                                                                                                                         |      |                               |      |               |
| $t_{dVdT}$                                               | Output ramp time                    | EN/UVLO $\uparrow$ to $V_{(OUT)} = 4.5\text{ V}$ , with $C_{(dVdT)} = \text{open}$                                                      |      | 0.12                          |      | ms            |
|                                                          |                                     | EN/UVLO $\uparrow$ to $V_{(OUT)} = 11\text{ V}$ , with $C_{(dVdT)} = \text{open}$                                                       | 0.25 | 0.37                          | 0.5  |               |
|                                                          |                                     | EN/UVLO $\uparrow$ to $V_{(OUT)} = 11\text{ V}$ , with $C_{(dVdT)} = 1\text{ nF}$                                                       |      | 0.97                          |      |               |
| <b>CURRENT LIMIT</b>                                     |                                     |                                                                                                                                         |      |                               |      |               |
| $t_{\text{FASTRIP(dly)}}$                                | Fast-trip comparator delay          | $I_{(OUT)} > I_{(\text{FASTRIP})}$                                                                                                      |      | 200                           |      | ns            |
| <b>REVERSE PROTECTION COMPARATOR</b>                     |                                     |                                                                                                                                         |      |                               |      |               |
| $t_{\text{REV(dly)}}$                                    | Reverse protection comparator delay | $(V_{(IN)} - V_{(OUT)})\downarrow$ (1 mV overdrive below $V_{(\text{REVTH})}$ ) to $\overline{\text{FLT}}\downarrow$                    |      | 10                            |      | $\mu\text{s}$ |
|                                                          |                                     | $(V_{(IN)} - V_{(OUT)})\downarrow$ (10 mV overdrive below $V_{(\text{REVTH})}$ ) to $\overline{\text{FLT}}\downarrow$                   |      | 1                             |      |               |
| $t_{\text{FWD(dly)}}$                                    |                                     | $(V_{(IN)} - V_{(OUT)})\uparrow$ (10 mV overdrive above $V_{(\text{FWDTH})}$ ) to $\overline{\text{FLT}}\uparrow$                       |      | 3.1                           |      |               |
| <b>POWER-GOOD COMPARATOR OUTPUT (PGOOD): ACTIVE HIGH</b> |                                     |                                                                                                                                         |      |                               |      |               |
| $t_{\text{PGOODR}}$                                      | PGOOD delay (de-glitch) time        | Rising edge                                                                                                                             | 0.42 | 0.54                          | 0.66 | ms            |
| $t_{\text{PGOODF}}$                                      |                                     | Falling edge                                                                                                                            | 0.42 | 0.54                          | 0.66 | ms            |
| <b>THERMAL SHUT DOWN (TSD)</b>                           |                                     |                                                                                                                                         |      |                               |      |               |
|                                                          | Retry delay in TSD                  | TPS25940-Q1 Only                                                                                                                        |      | 128                           |      | ms            |

### 6.7 Typical Characteristics

Conditions are  $-40^{\circ}\text{C} \leq T_A = T_J \leq 125^{\circ}\text{C}$ ,  $V_{(IN)} = 12\text{ V}$ ,  $V_{(EN/UVLO)} = 2\text{ V}$ ,  $V_{(OVP)} = V_{(DEVSLP)} = V_{(PGTH)} = 0\text{ V}$ ,  $R_{(ILIM)} = 150\text{ k}\Omega$ ,  $C_{(OUT)} = 1\text{ }\mu\text{F}$ ,  $C_{(dVdT)} = \text{OPEN}$ ,  $\text{PGOOD} = \text{FLT} = \text{IMON} = \text{OPEN}$ . (unless stated otherwise)

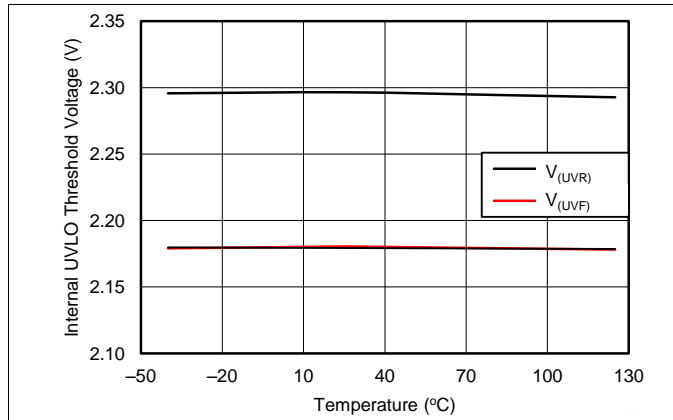

Figure 1. UVLO Threshold Voltage vs Temperature

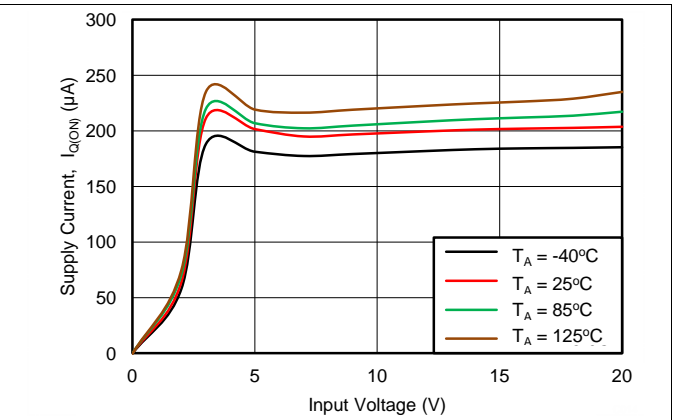

Figure 2. Input Supply Current vs Supply Voltage during Normal Operation

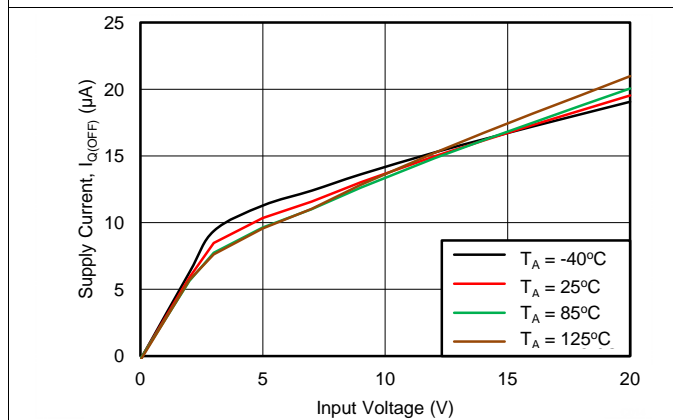

Figure 3. Input Supply Current vs Supply Voltage at Shutdown

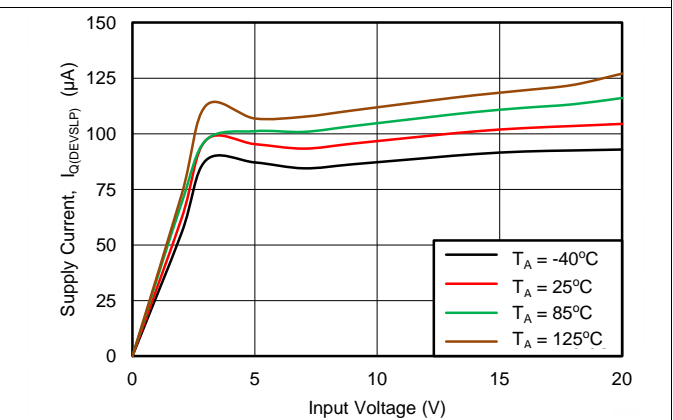

Figure 4. Input Supply Current vs Supply Voltage in DevSleep Mode

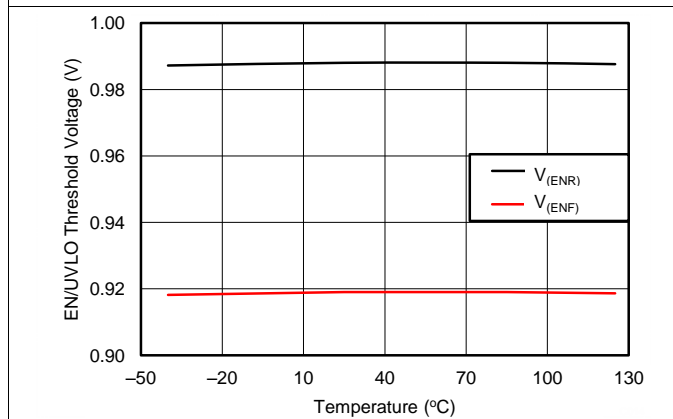

Figure 5. EN Threshold Voltage vs Temperature

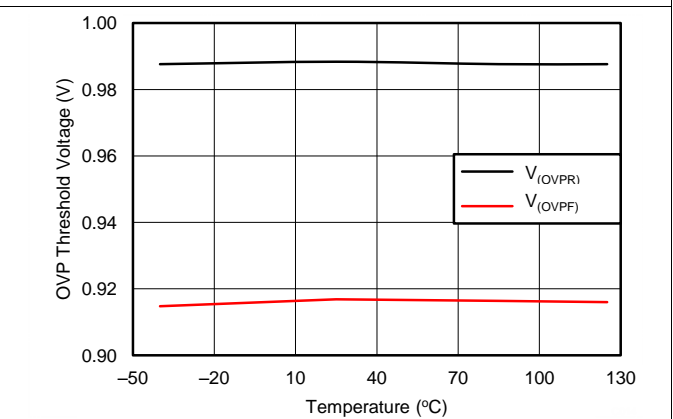

Figure 6. OVP Threshold Voltage vs Temperature



Typical Characteristics (continued)

Conditions are  $-40^{\circ}\text{C} \leq T_A = T_J \leq 125^{\circ}\text{C}$ ,  $V_{(IN)} = 12\text{ V}$ ,  $V_{(EN/UVLO)} = 2\text{ V}$ ,  $V_{(OVP)} = V_{(DEVSLP)} = V_{(PGTH)} = 0\text{ V}$ ,  $R_{(ILIM)} = 150\text{ k}\Omega$ ,  $C_{(OUT)} = 1\text{ }\mu\text{F}$ ,  $C_{(dVdT)} = \text{OPEN}$ ,  $\text{PGOOD} = \text{FLT} = \text{IMON} = \text{OPEN}$ . (unless stated otherwise)

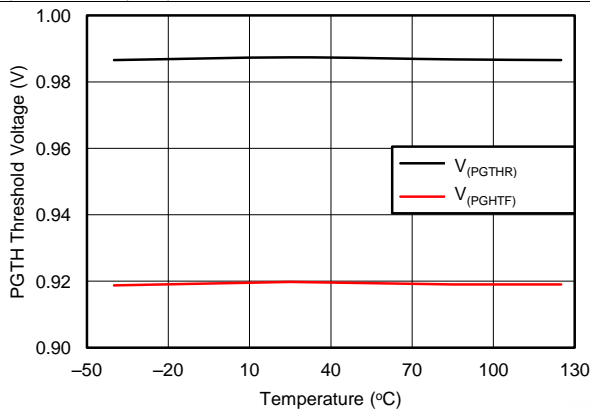

Figure 7. PGTH Threshold Voltage vs Temperature

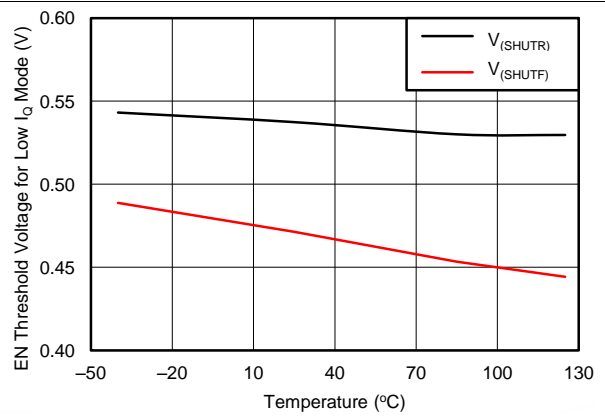

Figure 8. EN Threshold Voltage for Low IQ Mode vs Temperature

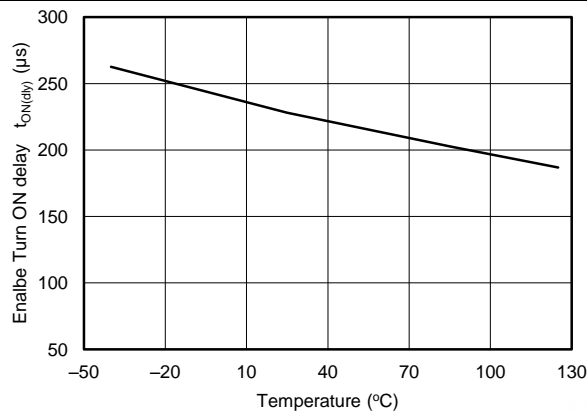

Figure 9. Enable Turn ON Delay vs Temperature

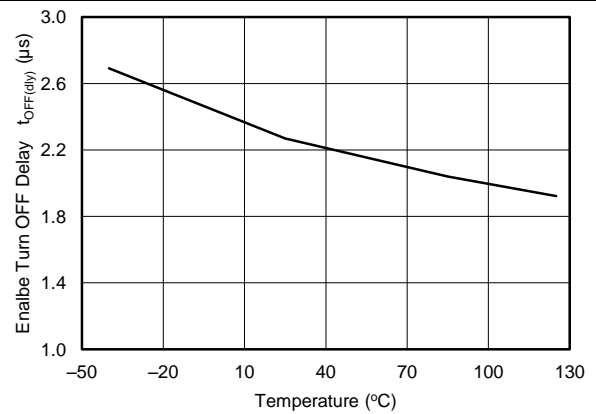

Figure 10. Enable Turn OFF Delay vs Temperature

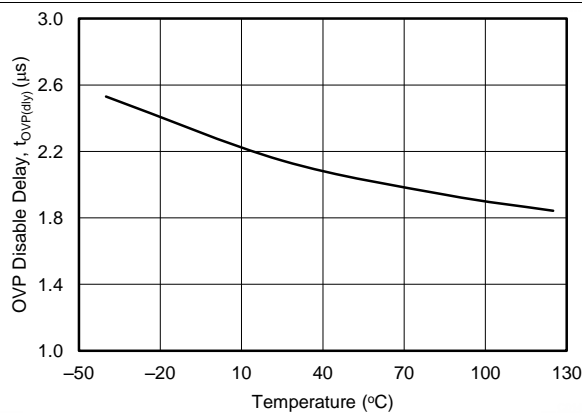

Figure 11. OVP Disable Delay vs Temperature

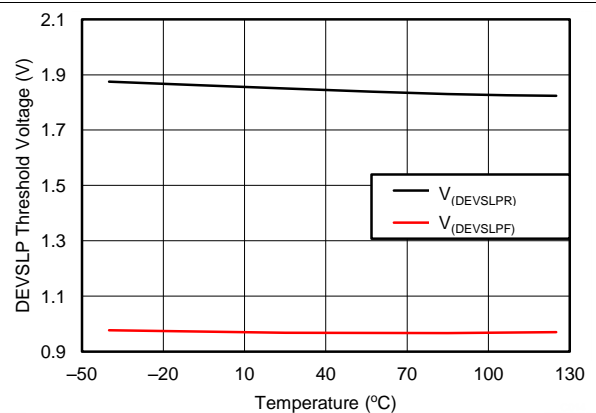

Figure 12. DEVSLP Threshold Voltage vs Temperature

Typical Characteristics (continued)

Conditions are  $-40^{\circ}\text{C} \leq T_A = T_J \leq 125^{\circ}\text{C}$ ,  $V_{(IN)} = 12\text{ V}$ ,  $V_{(EN/UVLO)} = 2\text{ V}$ ,  $V_{(OVP)} = V_{(DEVSLP)} = V_{(PGTH)} = 0\text{ V}$ ,  $R_{(LIM)} = 150\text{ k}\Omega$ ,  $C_{(OUT)} = 1\text{ }\mu\text{F}$ ,  $C_{(dVdT)} = \text{OPEN}$ ,  $\text{PGOOD} = \text{FLT} = \text{IMON} = \text{OPEN}$ . (unless stated otherwise)

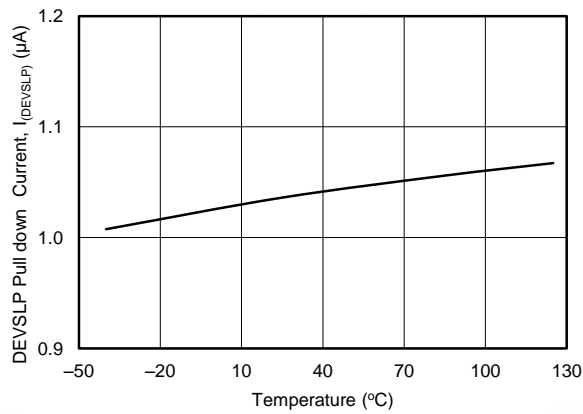

Figure 13. DEVSLP Pull Down Current vs Temperature

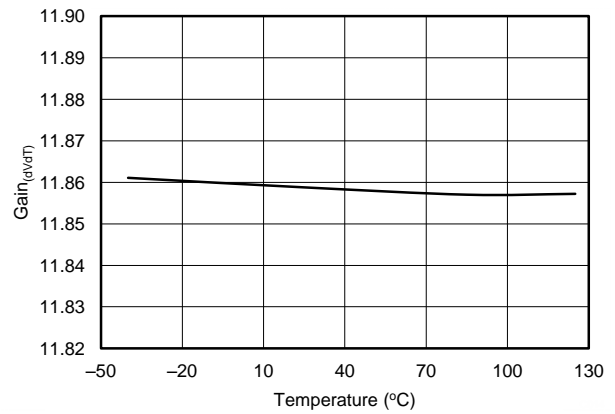

Figure 14. GAIN<sub>(dVdT)</sub> vs Temperature

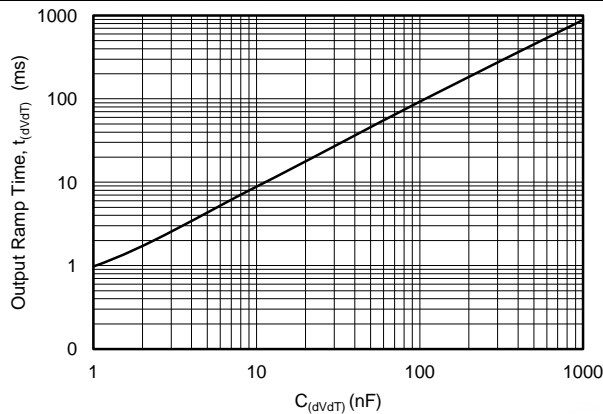

Figure 15. Output Ramp Time vs  $C_{(dVdT)}$

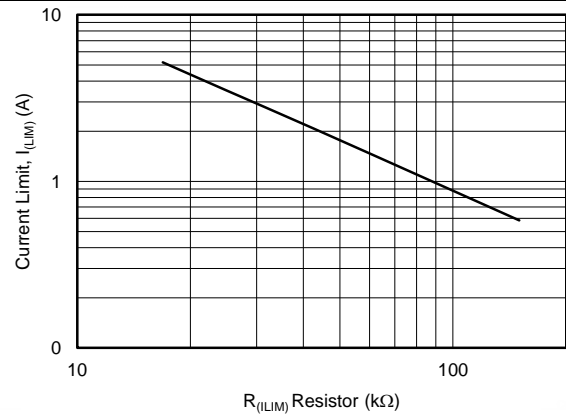

Figure 16. Current Limit vs Current Limit Resistor

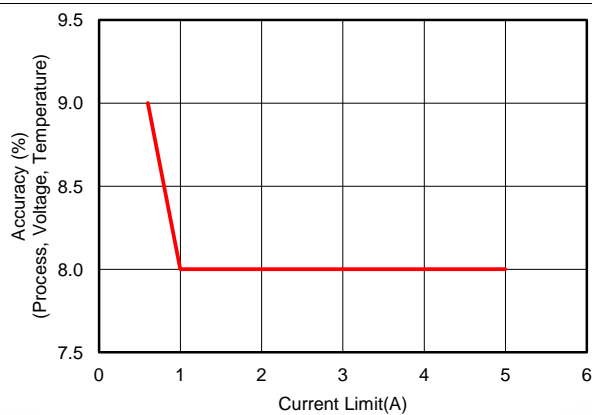

Figure 17. Current Limit Accuracy vs Current Limit

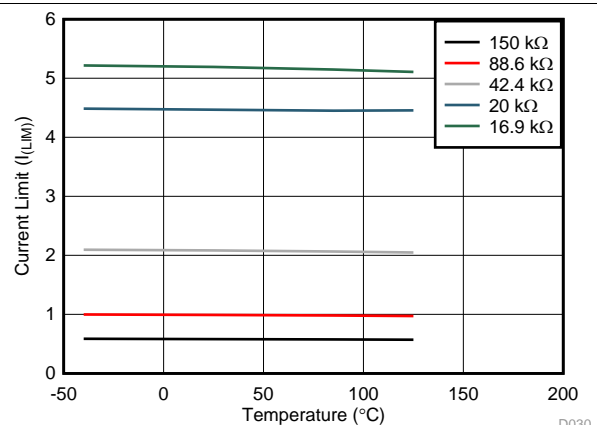

Figure 18. Current Limit vs Temperature Across  $R_{(LIM)}$

Typical Characteristics (continued)

Conditions are  $-40^{\circ}\text{C} \leq T_A = T_J \leq 125^{\circ}\text{C}$ ,  $V_{(IN)} = 12\text{ V}$ ,  $V_{(EN/UVLO)} = 2\text{ V}$ ,  $V_{(OVP)} = V_{(DEVSLP)} = V_{(PGTH)} = 0\text{ V}$ ,  $R_{(ILIM)} = 150\text{ k}\Omega$ ,  $C_{(OUT)} = 1\text{ }\mu\text{F}$ ,  $C_{(dVdT)} = \text{OPEN}$ ,  $\text{PGOOD} = \text{FLT} = \text{IMON} = \text{OPEN}$ . (unless stated otherwise)

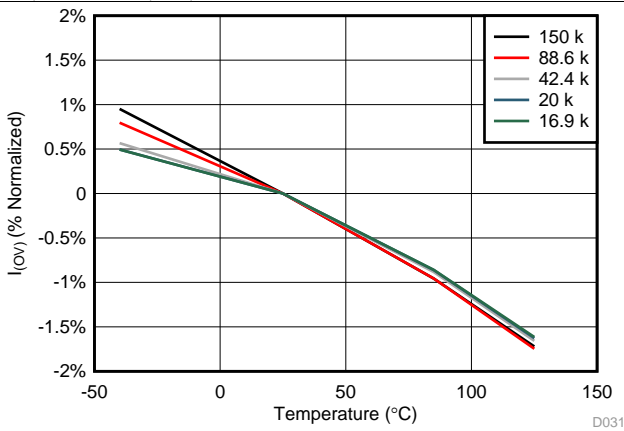

Figure 19. Current Limit (% Normalized) vs  $R_{(LIMIT)}$  Resistor

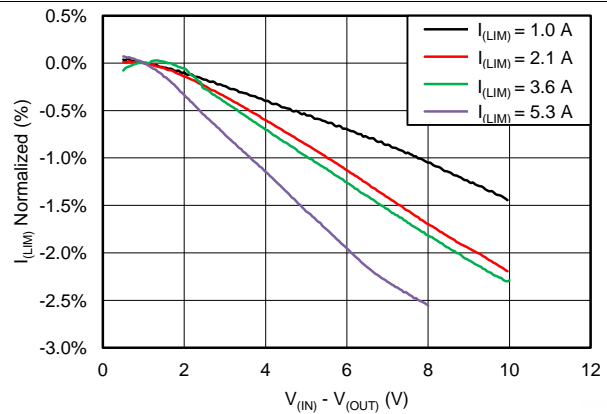

Figure 20. Current Limit Normalized (%) vs  $V_{(IN)} - V_{(OUT)}$   
 Thermal shutdown occurs when  $I_{(LIM)} = [V_{(IN)} - V_{(OUT)}] > 8\text{ V}$   
 5.3 A

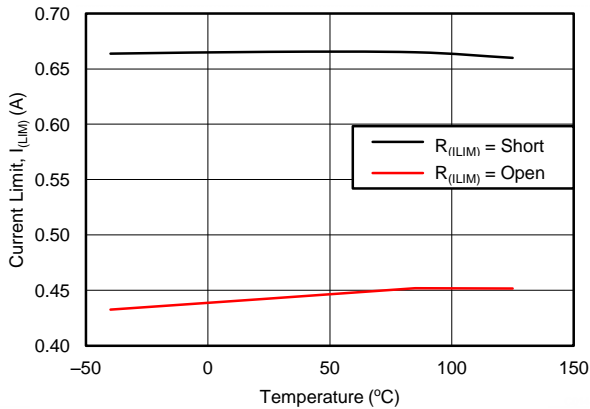

Figure 21. Current Limit for  $R_{(ILIM)} = \text{Open and Short vs Temperature}$

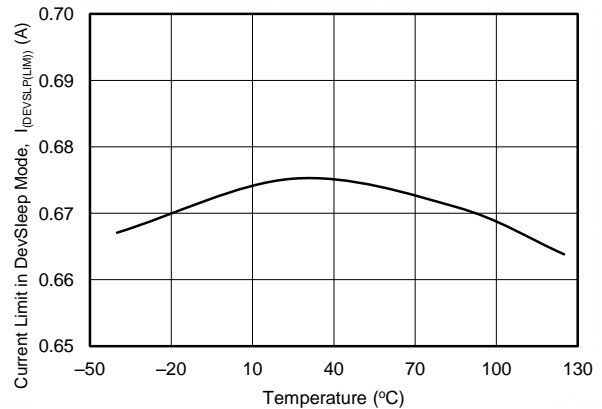

Figure 22. Current Limit in DevSleep Mode vs Temperature

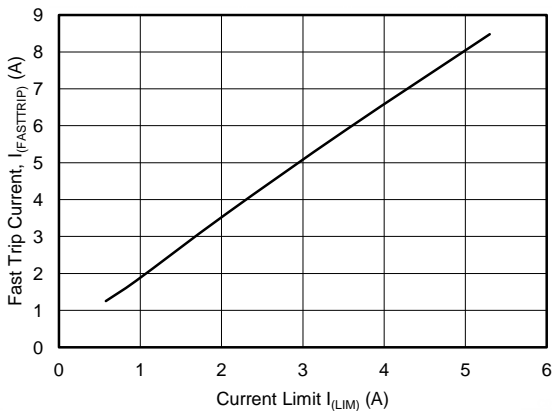

Figure 23. Fast Trip Threshold vs Current Limit

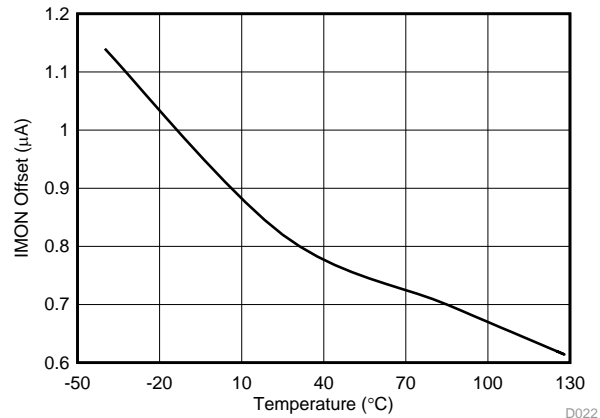

Figure 24. IMON Offset vs Temperature

Typical Characteristics (continued)

Conditions are  $-40^{\circ}\text{C} \leq T_A = T_J \leq 125^{\circ}\text{C}$ ,  $V_{(IN)} = 12\text{ V}$ ,  $V_{(EN/UVLO)} = 2\text{ V}$ ,  $V_{(OVP)} = V_{(DEVSLP)} = V_{(PGTH)} = 0\text{ V}$ ,  $R_{(ILIM)} = 150\text{ k}\Omega$ ,  $C_{(OUT)} = 1\text{ }\mu\text{F}$ ,  $C_{(dVdT)} = \text{OPEN}$ ,  $\text{PGOOD} = \text{FLT} = \text{IMON} = \text{OPEN}$ . (unless stated otherwise)

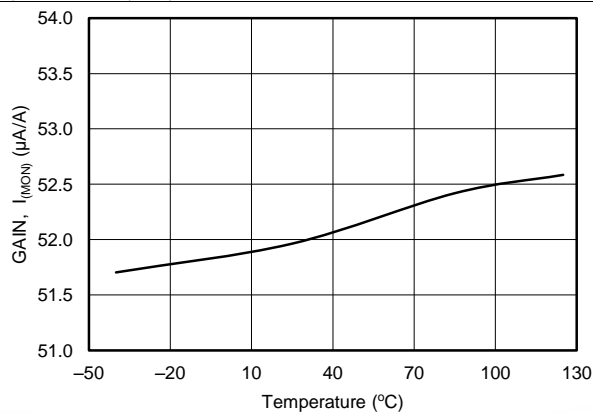

Figure 25. GAIN<sub>(MON)</sub> vs Temperature

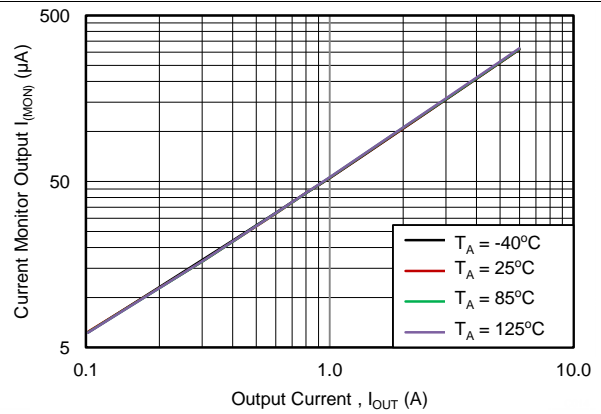

Figure 26. Current Monitor Output vs Output Current

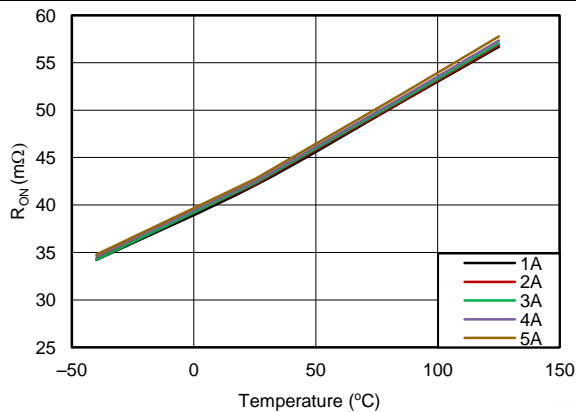

Figure 27.  $R_{ON}$  vs Temperature Across Load Current

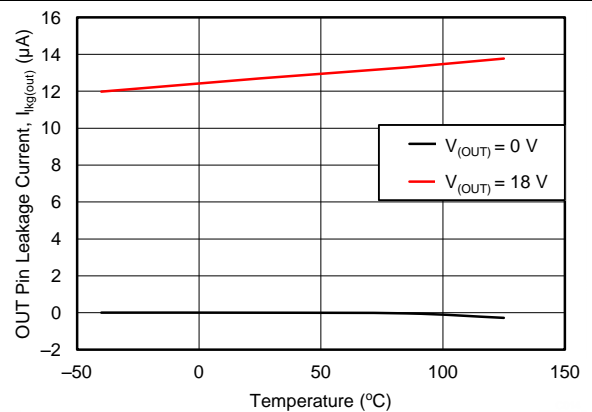

Figure 28. OUT Leakage Current in Off State vs Temperature

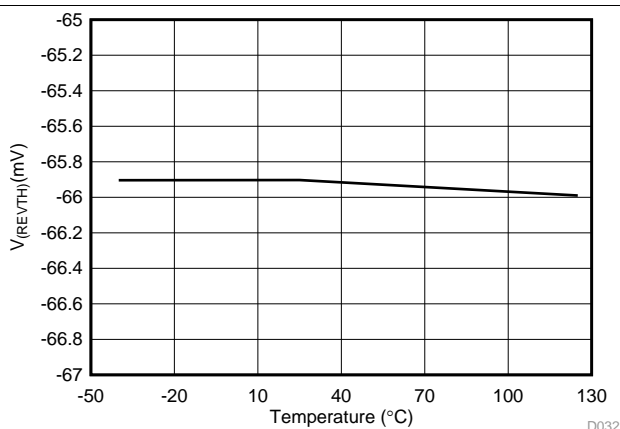

Figure 29.  $V_{(REVTH)}$  vs Temperature

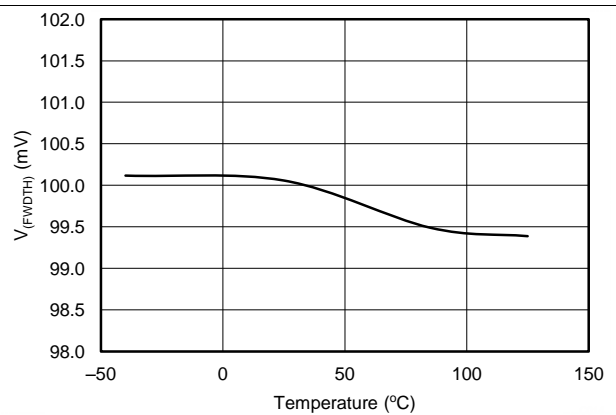
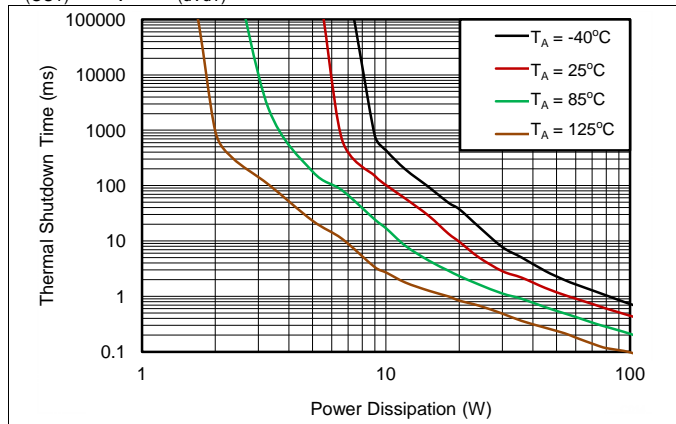

Figure 30.  $V_{(FWDTH)}$  vs Temperature

Typical Characteristics (continued)

Conditions are  $-40^{\circ}\text{C} \leq T_A = T_J \leq 125^{\circ}\text{C}$ ,  $V_{(IN)} = 12\text{ V}$ ,  $V_{(EN/UVLO)} = 2\text{ V}$ ,  $V_{(OVP)} = V_{(DEVSLP)} = V_{(PGTH)} = 0\text{ V}$ ,  $R_{(ILIM)} = 150\text{ k}\Omega$ ,  $C_{(OUT)} = 1\text{ }\mu\text{F}$ ,  $C_{(dVdT)} = \text{OPEN}$ ,  $\text{PGOOD} = \text{FLT} = \text{IMON} = \text{OPEN}$ . (unless stated otherwise)



Taken on 2-Layer board, 2 oz.(0.08-mm thick) with GND plane area: 14 cm<sup>2</sup> (Top) and 20 cm<sup>2</sup> (bottom)

Figure 31. Thermal Shutdown Time vs Power Dissipation

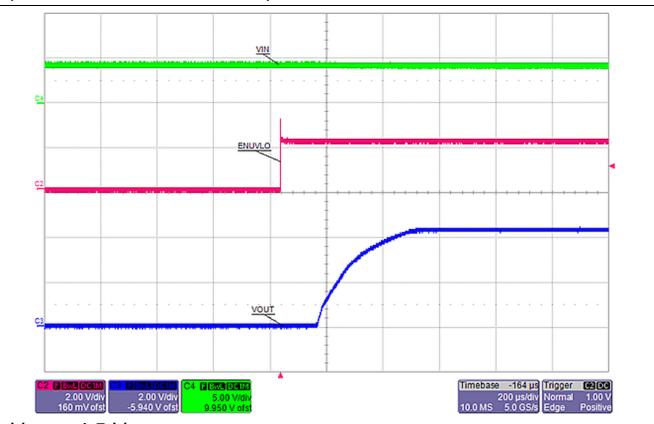

$V_{(IN)} = 4.5\text{ V}$

Figure 32. Turn ON with Enable

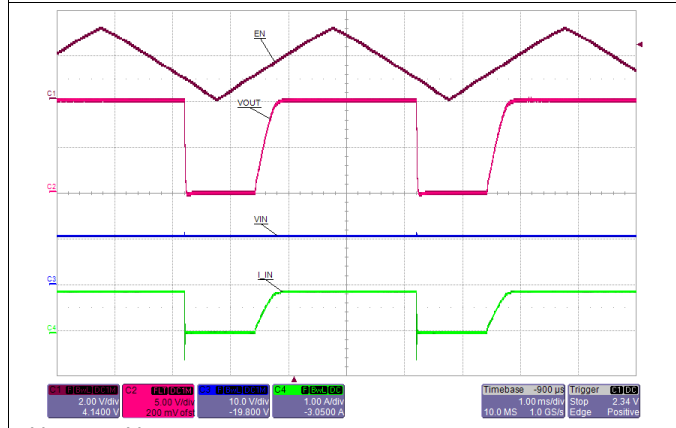

$V_{(IN)} = 11\text{ V}$

Figure 33. Turn ON and OFF with Enable

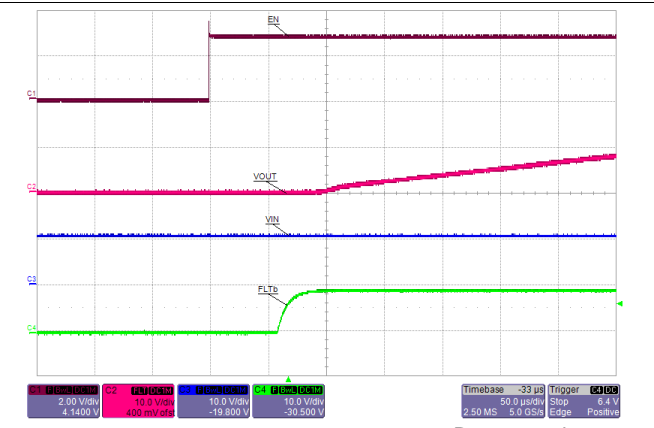

$R_{(FLT)} = 100\text{ k}\Omega$

Figure 34. EN Turn ON Delay : EN ↑ to Output Ramp ↑

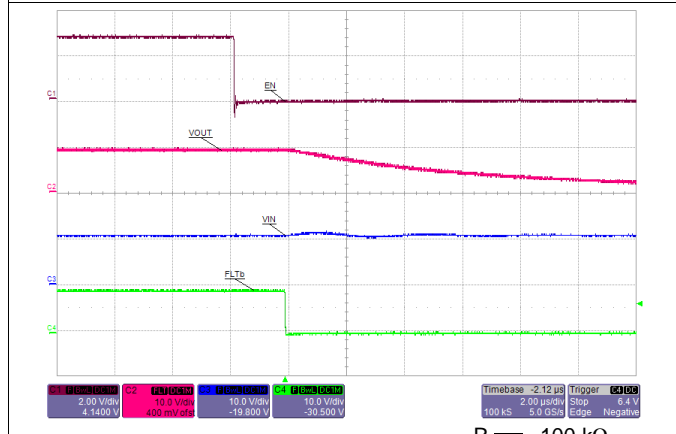

$R_{(FLT)} = 100\text{ k}\Omega$

Figure 35. EN Turn OFF Delay : EN ↓ to Fault ↓

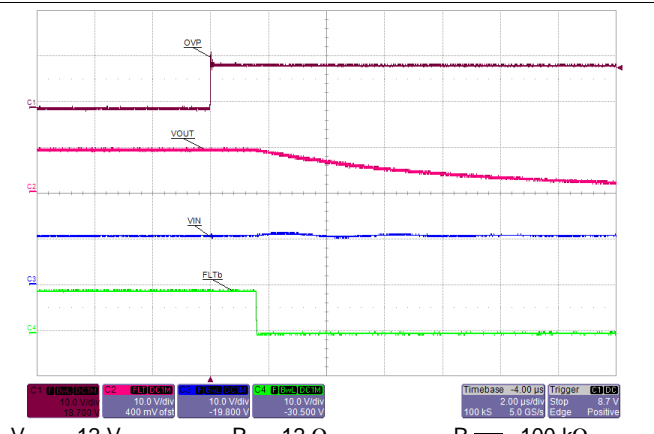

$V_{(IN)} = 12\text{ V}$        $R_L = 12\text{ }\Omega$        $R_{(FLT)} = 100\text{ k}\Omega$

Figure 36. OVP Turn OFF Delay: OVP ↑ to Fault ↓

Typical Characteristics (continued)

Conditions are  $-40^{\circ}\text{C} \leq T_A = T_J \leq 125^{\circ}\text{C}$ ,  $V_{(IN)} = 12\text{ V}$ ,  $V_{(EN/UVLO)} = 2\text{ V}$ ,  $V_{(OVP)} = V_{(DEVSLP)} = V_{(PGTH)} = 0\text{ V}$ ,  $R_{(ILIM)} = 150\text{ k}\Omega$ ,  $C_{(OUT)} = 1\text{ }\mu\text{F}$ ,  $C_{(dVdT)} = \text{OPEN}$ ,  $\text{PGOOD} = \text{FLT} = \text{IMON} = \text{OPEN}$ . (unless stated otherwise)

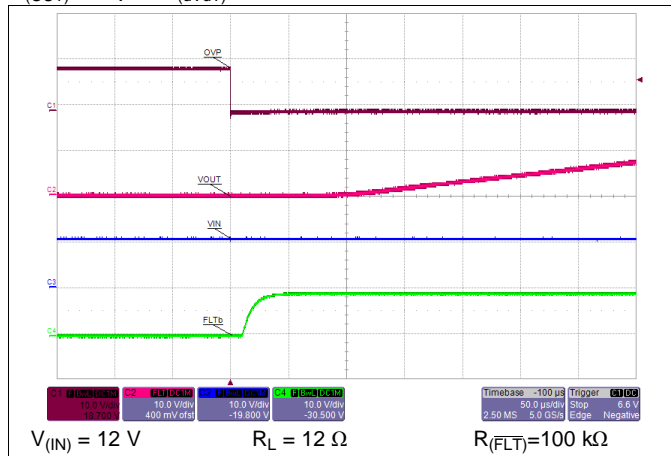

Figure 37. OVP Turn ON Delay: OVP ↓ to Output Ramp ↑

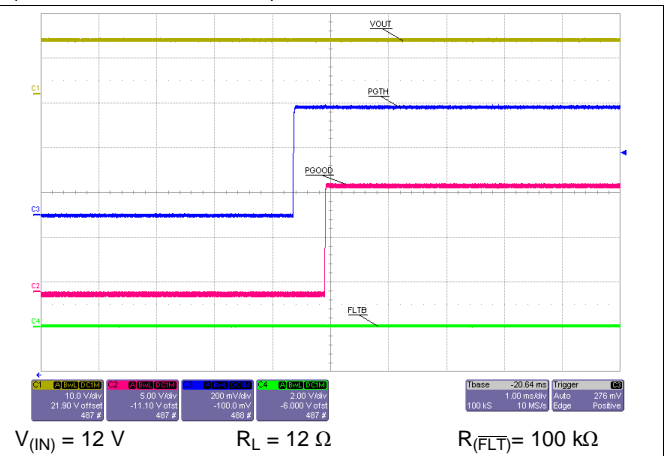

Figure 38. Power Good Delay (Rising)

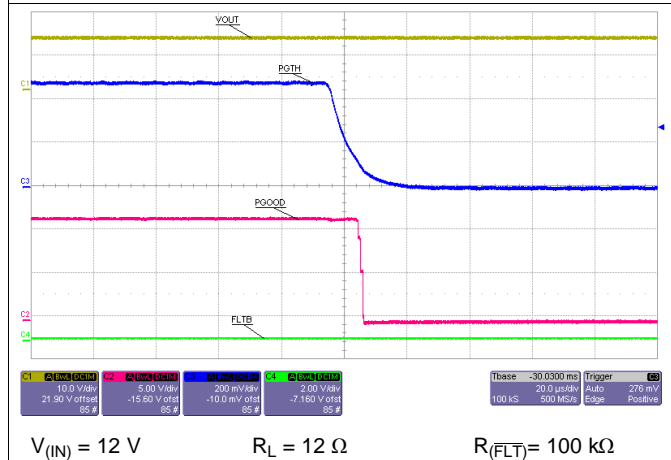

Figure 39. Power Good Delay (Falling)

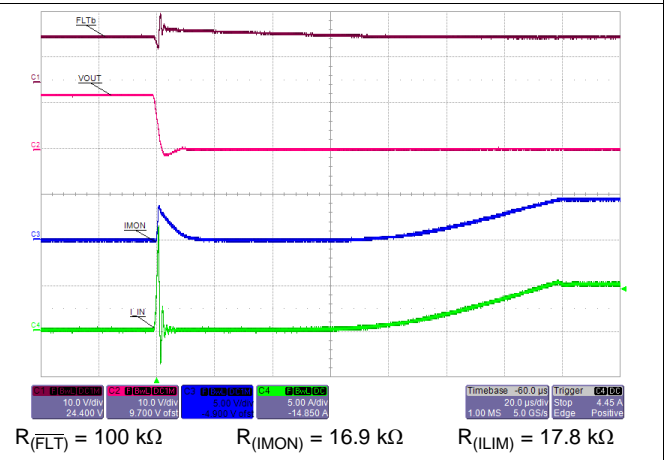

Figure 40. Hot-Short: Fast Trip Response and Current Regulation

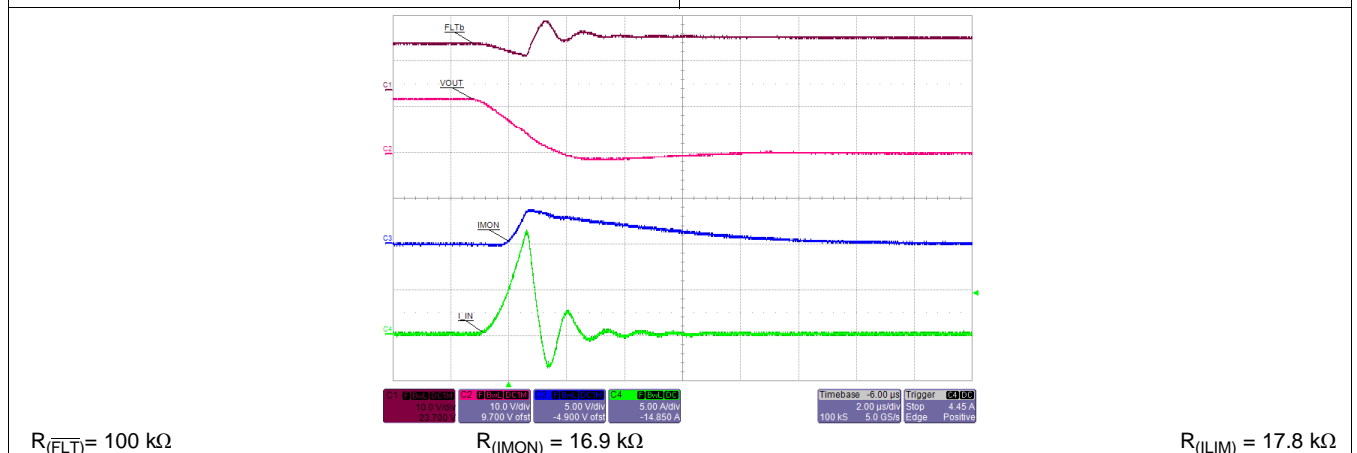

Figure 41. Hot-Short: Fast Trip Response (Zoomed)

## 7 Parametric Measurement Information

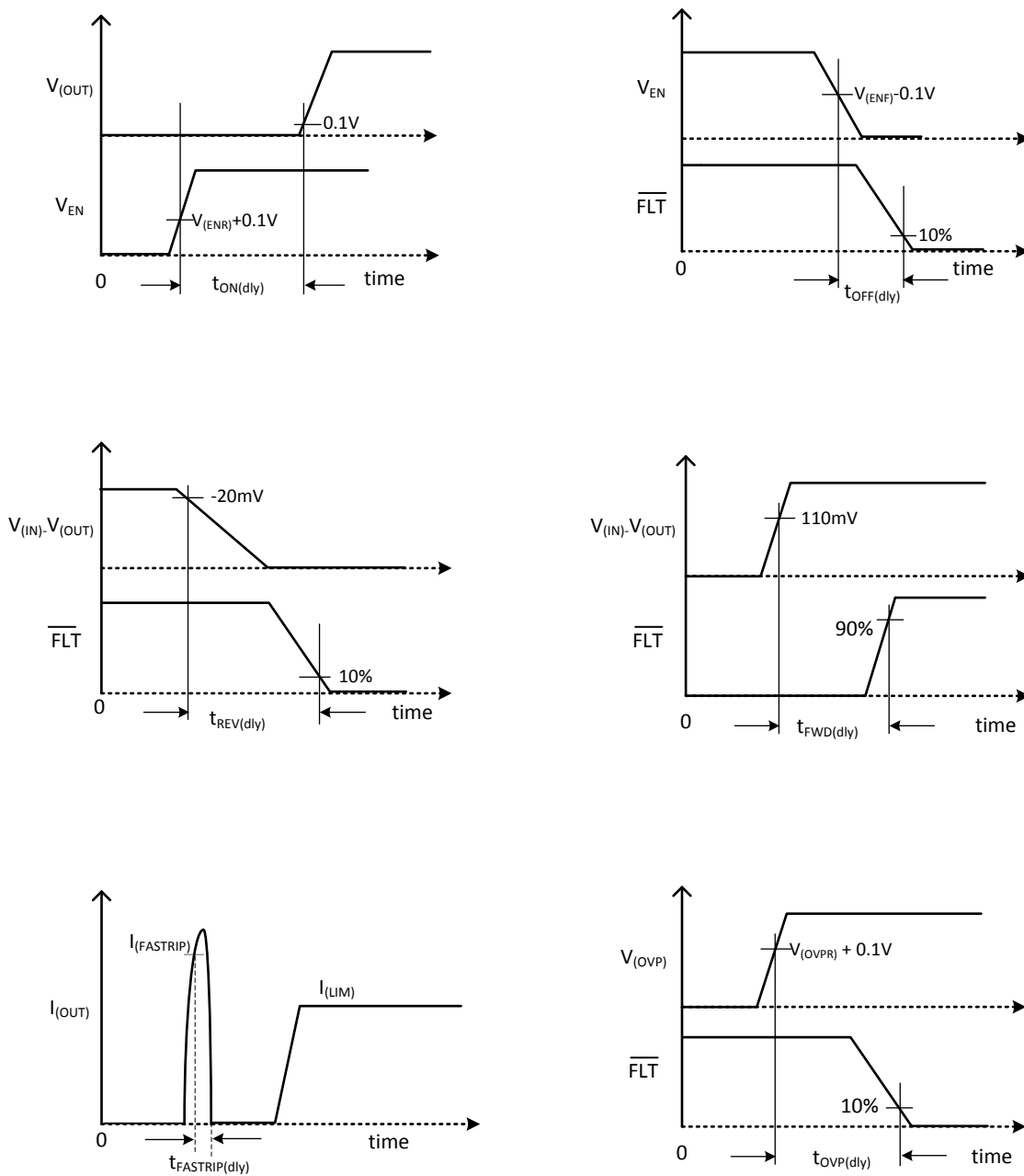

Figure 42. Timing Diagrams

## 8 Detailed Description

### 8.1 Overview

The TPS25940x-Q1 device is a smart eFuse with integrated back-to-back FETs and enhanced built-in protection circuitry. It provides robust protection for all systems and applications powered from 2.7 V to 18 V.

For hot-plug-in boards, the device provides hot-swap power management with in-rush current control and programmable output ramp-rate. The device integrates overcurrent and short circuit protection. The precision overcurrent limit helps to minimize over design of the input power supply, while the fast response short circuit protection immediately isolates the load from input when a short circuit is detected. The device allows the user to program the overcurrent limit threshold between 0.6 A and 5.3 A via an external resistor.

The device provides precise monitoring of voltage bus for brown-out and overvoltage conditions and asserts fault for downstream system. Its overall threshold accuracy of 2% ensures tight supervision of bus, eliminating the need for a separate supply voltage supervisor chip.

The device is designed to protect systems such as USB hubs against sudden output short to battery events. The device monitors  $V_{(IN)}$  and  $V_{(OUT)}$  to provide true reverse blocking from output when output short to battery fault condition or input power fail condition is detected.

The additional features include:

- Precise current monitor output for health monitoring of the system
- Additional power good comparator with precision internal reference for output or any other rail voltage monitoring
- Over temperature protection to safely shutdown in the event of an overcurrent event
- De-glitched fault reporting for brown-out and overvoltage faults
- A choice of latched or automatic restart mode



### 8.2 Functional Block Diagram

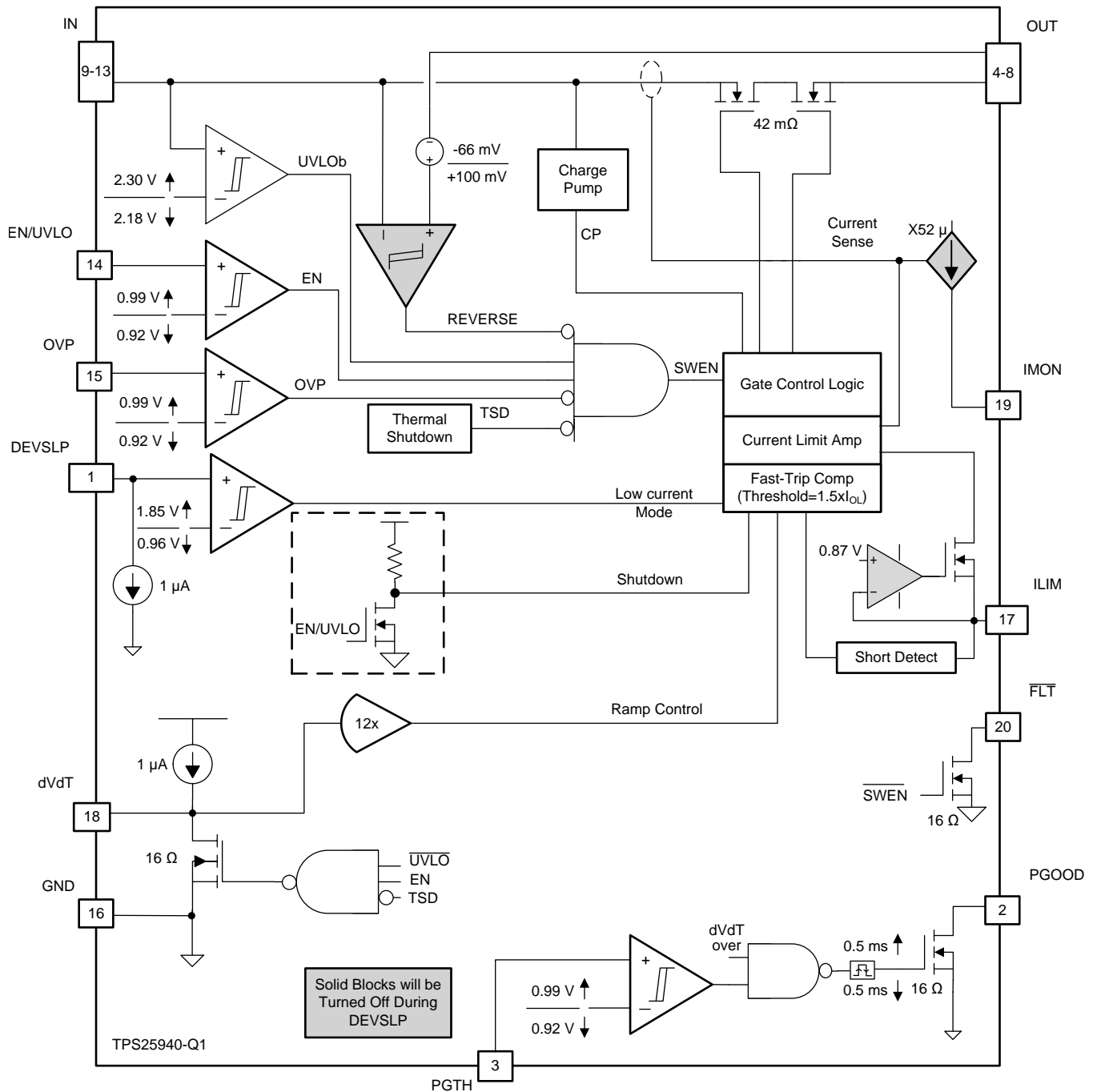

## 8.3 Feature Description

### 8.3.1 Enable and Adjusting Undervoltage Lockout

The EN/UVLO pin controls the ON and OFF state of the internal FET. A voltage  $V_{(EN/UVLO)} < V_{(ENF)}$  on this pin turns off the internal FET, thus disconnecting IN from OUT, while voltage below  $V_{(SHUTF)}$  takes the device into shutdown mode, with  $I_Q$  less than 15  $\mu$ A to ensure minimal power loss. Cycling EN/UVLO low and then back high resets the TPS25940L-Q1 that has latched off due to a fault condition.

The internal de-glitch delay on EN/UVLO falling edge is kept low for quick detection of power failure. For applications where a higher de-glitch delay on EN/UVLO is desired, or when the supply is particularly noisy, it is recommended to use an external bypass capacitor from EN/UVLO terminal to GND.

The undervoltage lock out can be programmed by using an external resistor divider from supply IN terminal to EN/UVLO terminal to GND as shown in [Figure 43](#). When an undervoltage or input power fail event is detected, the internal FET is quickly turned off, and  $\overline{FLT}$  is asserted. If the Under-Voltage Lock-Out function is not needed, the EN/UVLO terminal must be connected to the IN terminal. EN/UVLO terminal must not be left floating.

The device also implements internal undervoltage-lockout (UVLO) circuitry on the IN terminal. The device disables when the IN terminal voltage falls below internal UVLO Threshold  $V_{(UVF)}$ . The internal UVLO threshold has a hysteresis of 115 mV.

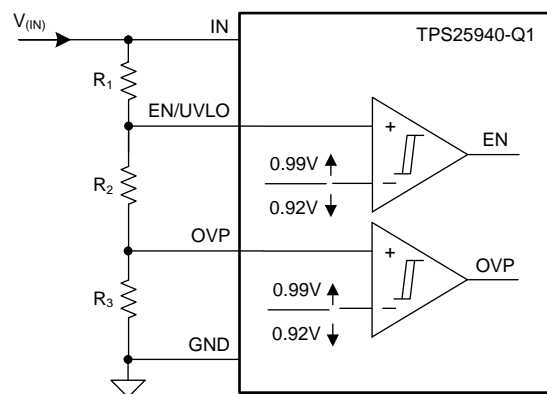

**Figure 43. UVLO and OVP Thresholds Set By  $R_1$ ,  $R_2$  and  $R_3$**

### 8.3.2 Overvoltage Protection (OVP)

The device incorporates circuit to protect system during overvoltage conditions. A resistor divider connected from the supply to OVP terminal to GND (as shown in [Figure 43](#)) programs the overvoltage threshold. A voltage more than  $V_{(OVPR)}$  on OVP pin turns off the internal FET and protects the downstream load. This pin must be tied to GND when not used.

### 8.3.3 Hot Plug-In and In-Rush Current Control

The device is designed to control the in-rush current upon insertion of a card into a live backplane or other "hot" power source. This limits the voltage sag on the backplane's supply voltage and prevents unintended resets of the system power. A slew rate controlled startup (dVdT) also helps to eliminate conductive and radiative interferences. An external capacitor connected from the dVdT pin to GND defines the slew rate of the output voltage at power-on (as shown in [Figure 44](#)). Equation governing slew rate at start-up is shown in [Equation 1](#).

## Feature Description (continued)

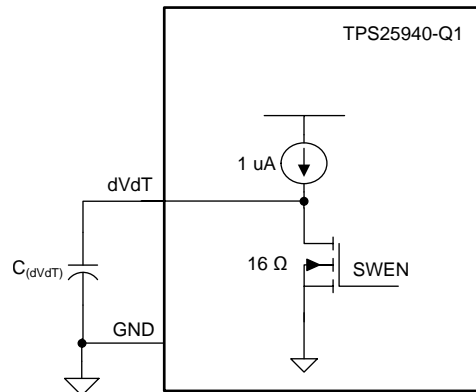

**Figure 44. Output Ramp Up Time  $t_{dVdT}$  is Set by  $C_{dVdT}$**

$$I_{(dVdT)} = \left( \frac{C_{(dVdT)}}{GAIN_{(dVdT)}} \right) \times \left( \frac{dV_{(OUT)}}{dt} \right)$$

where

- $I_{(dVdT)} = 1 \mu A$  (typical)
- $\frac{dV_{(OUT)}}{dt}$  = Desired output slew rate
- $GAIN_{(dVdT)} = dVdT$  to OUT gain = 12

The total ramp time ( $t_{dVdT}$ ) of  $V_{(OUT)}$  for 0 to  $V_{(IN)}$  can be calculated using [Equation 2](#).

$$t_{dVdT} = 8.3 \times 10^4 \times V_{(IN)} \times C_{(dVdT)}$$

The inrush current,  $I_{(INRUSH)}$  can be calculated as shown in [Equation 3](#).

$$I_{(INRUSH)} = C_{(OUT)} \times V_{(IN)} / t_{dVdT}$$

The dVdT pin can be left floating to obtain a predetermined slew rate ( $t_{dVdT}$ ) on the output. When terminal is left floating, the device sets an internal ramp rate of 30 V/ms for output ( $V_{(OUT)}$ ) ramp.

[Figure 57](#) and [Figure 58](#) illustrate the inrush current control behavior of the device. For systems where load is present during start-up, the current never exceeds the overcurrent limit set by  $R_{(ILIM)}$  resistor for the application. For defining appropriate charging time-rate under different load conditions, see the [Setting Output Voltage Ramp Time \( \$t\_{dVdT}\$ \)](#) section.

### 8.3.4 Overload and Short Circuit Protection

At all times load current is monitored by sensing voltage across an internal sense resistor. During overload events, current is limited to the current limit ( $I_{(LIM)}$ ) programmed by  $R_{(ILIM)}$  resistor as shown in [Equation 4](#).

$$I_{(LIM)} = \frac{89}{R_{(ILIM)}}$$

where

- $I_{(LIM)}$  is overload current limit in Ampere
- $R_{(ILIM)}$  is the current limit resistor in  $k\Omega$

The device incorporates two distinct levels: a current limit ( $I_{(LIM)}$ ) and a fast-trip threshold ( $I_{(FASTTRIP)}$ ). Fast trip and current limit operation are shown in [Figure 45](#).

Bias current on ILIM pin directly controls current-limiting behavior of the device, and PCB routing of this node must be kept away from any noisy (switching) signals.

## Feature Description (continued)

### 8.3.4.1 Overload Protection

For overload conditions, the internal current-limit amplifier regulates the output current to  $I_{(LIM)}$ . The output voltage droops during the current regulation, resulting in increased power dissipation in the device. If the device junction temperature reaches the thermal shutdown threshold ( $T_{(TSD)}$ ), the internal FET is turned off. When in thermal shutdown, the TPS25940L-Q1 version stays latched off, whereas the TPS25940-Q1 commences an auto-retry cycle 128 ms after  $T_J < [T_{(TSD)} - 12^\circ\text{C}]$ . During thermal shutdown, the fault pin  $\overline{FLT}$  pulls low to signal a fault condition. [Figure 61](#) and [Figure 62](#) illustrate overload behavior.

### 8.3.4.2 Short Circuit Protection

During a transient short circuit event, the current through the device increases very rapidly. As current-limit amplifier cannot respond quickly to this event because of its limited bandwidth, the device incorporates a fast-trip comparator, with a threshold  $I_{(FASTRIP)}$ . This comparator shuts down the pass device within  $1\mu\text{s}$ , when the current through internal FET exceeds  $I_{(FASTRIP)}$  ( $I_{(OUT)} > I_{(FASTRIP)}$ ), and terminates the rapid short-circuit peak current. The trip threshold is set to more than 50% of the programmed overload current limit ( $I_{(FASTRIP)} = 1.5 \times I_{(LIM)} + 0.375$ ). The fast-trip circuit holds the internal FET off for only a few microseconds, after which the device turns back on slowly, allowing the current-limit loop to regulate the output current to  $I_{(LIM)}$ . Then, device behaves similar to overload condition. [Figure 63](#) through [Figure 64](#) illustrate the behavior of the system when the current exceeds the fast-trip threshold.

### 8.3.4.3 Start-Up with Short on Output

During start-up into a short circuit current is limited to  $I_{(LIM)}$ . [Figure 45](#) and [Figure 65](#) illustrate start-up with a short on the output. This feature helps in quick fault isolation and hence ensures stability of the DC bus.

### 8.3.4.4 Constant Current Limit Behavior During Overcurrent Faults

When power dissipation in the internal FET [ $P_D = (V_{(IN)} - V_{(OUT)}) \times I_{(OUT)}$ ]  $> 10\text{ W}$ , there is approximately 0% to 5% thermal fold back in the current limit value so that  $I_{(LIM)}$  drops to  $I_{OS}$ . Eventually, the device shuts down because of over temperature.

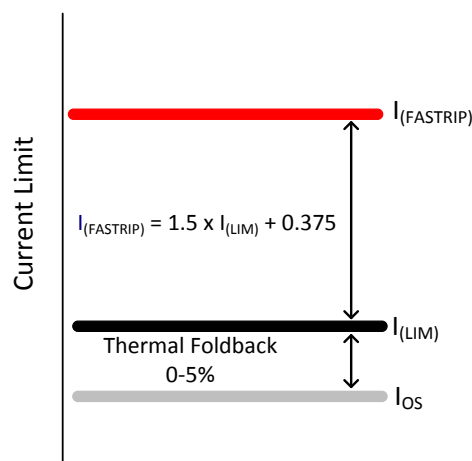

**Figure 45. Fast-Trip Current**

## 8.3.5 FAULT Response

The  $\overline{FLT}$  open-drain output is asserted (active low) during undervoltage, overvoltage, reverse voltage-current and thermal shutdown conditions. The  $\overline{FLT}$  signal remains asserted until the fault condition is removed and the device resumes normal operation. The device is designed to eliminate false fault reporting by using an internal "de-glitch" circuit for undervoltage and overvoltage (2.2  $\mu\text{s}$  typical) conditions without the need for external circuitry. This ensures that fault is not accidentally asserted during transients on input bus.

Connect  $\overline{FLT}$  with a pull up resistor to Input or Output voltage rail.  $\overline{FLT}$  may be left open or tied to ground when not used.  $V_{(IN)}$  falling below  $V_{(UVF)} = 2.1\text{ V}$  resets  $\overline{FLT}$ .

## Feature Description (continued)

### 8.3.6 Current Monitoring

The current source at IMON terminal is configured to be proportional to the current flowing from IN to OUT. This current can be converted to a voltage using a resistor  $R_{(IMON)}$  from IMON terminal to GND terminal. This voltage, computed using [Equation 6](#), can be used as a means of monitoring current flow through the system.

The maximum voltage range for monitoring the current ( $V_{(IMONmax)}$ ) is limited to minimum( $[V_{(IN)} - 2.2 \text{ V}]$ , 6 V) to ensure linear output. This puts limitation on maximum value of  $R_{(IMON)}$  resistor and is determined by [Equation 5](#).

$$R_{(IMONmax)} = \frac{\text{minimum}(V_{(IN)} - 2.2, 6)}{1.6 \times I_{(LIM)} \times \text{GAIN}_{(IMON)}} \quad (5)$$

The output voltage at IMON terminal is calculated from [Equation 6](#).

$$V_{(IMON)} = [I_{(OUT)} \times \text{GAIN}_{(IMON)} + I_{(IMON\_OS)}] \times R_{(IMON)}$$

where

- $\text{GAIN}_{(IMON)}$  = Gain factor  $I_{(IMON)}:I_{(OUT)} = 52 \mu\text{A/A}$
  - $I_{(OUT)}$  = Load current
  - $I_{(IMON\_OS)} = 0.8 \mu\text{A}$  (typical)
- (6)

This pin must not have a bypass capacitor to avoid delay in the current monitoring information.

The voltage at IMON pin can be digitized using an ADC (such as ADS1100, [SBAS239](#)) to read the current monitor information over an I<sup>2</sup>C bus.

### 8.3.7 Power Good Comparator

The device incorporates a Power Good comparator for co-ordination of status to downstream DC-DC converters or system monitoring circuits. The comparator has an internal reference of  $V_{(PGTHR)} = 0.99 \text{ V}$  at negative terminal and positive terminal PGTH can be utilized for monitoring of either input or output of the device. The comparator output PGOOD is an open-drain active high signal, which can be used to indicate the status to downstream units. PGOOD is asserted high when internal FET is fully enhanced and PGTH pin voltage is higher than internal reference  $V_{(PGTHR)}$ .

The PGOOD signal has deglitch time incorporated to ensure that internal FET is fully enhanced before heavy load is applied by downstream converters. Rising de-glitch delay is determined by [Equation 7](#).

$$t_{PGOOD(deg)} = \text{Maximum}\{(3.5 \times 10^6 \times C_{(dVdT)}), t_{PGOODR}\} \quad (7)$$

Connect the PGOOD pin with a pull up resistor to Input or Output voltage rail. PGOOD may be left open or tied to ground when not used.

### 8.3.8 IN, OUT and GND Pins

The device has multiple pins for input (IN) and output (OUT).

All IN pins must be connected together and to the power source. A ceramic bypass capacitor close to the device from IN to GND is recommended to alleviate bus transients. The recommended operating voltage range is 2.7 V – 18 V.

Similarly all OUT pins must be connected together and to the load.  $V_{(OUT)}$  in the ON condition, is calculated using [Equation 8](#).

$$V_{(OUT)} = V_{(IN)} - (R_{ON} \times I_{(OUT)}) \quad (8)$$

where,  $R_{ON}$  is the total ON resistance of the internal FET.

GND terminal is the most negative voltage in the circuit and is used as a reference for all voltage reference unless otherwise specified.

### 8.3.9 Thermal Shutdown

Internal over temperature shutdown disables turns off the FET when  $T_J > 160^\circ\text{C}$  (typical). The TPS25940L-Q1 version stays latched off, whereas TPS25940-Q1 commences an auto-retry cycle 128 ms after  $T_J$  drops below  $[T_{(TSD)} - 12^\circ\text{C}]$ . During the thermal shutdown, the fault pin  $\overline{\text{FLT}}$  pulls low to signal a fault condition.

## 8.4 Device Functional Modes

### 8.4.1 DevSleep Mode

The TPS25940x-Q1 device provides a dedicated DevSleep interface terminal (DEVSLP) to drive the device in low power mode. When pulled high, it puts the device in low power DevSleep mode. In this mode, the quiescent current consumption of the device is limited to less than 130  $\mu\text{A}$  (95  $\mu\text{A}$  typical). During this mode, the output voltage remains active, the overload current limit is set to  $I_{(DEVSLP(LIM))}$  and functionality of reverse comparator and current monitoring is disabled. All other protections are kept active ensuring the safety of the system even in DevSleep mode.

User must ensure that load currents on the bus are limited to less than  $I_{(DEVSLP(LIM))}$ , when the device is driven to DevSleep mode. Also, while coming out of DevSleep, it is important to sequence the TPS25940x-Q1 earlier than the load. Otherwise, the load can exceed  $I_{(DEVSLP(LIM))}$  and cause the TPS25940x-Q1 to enter the overload mode.

Figure 46 through Figure 49 illustrate the behavior of the system in DevSleep mode.

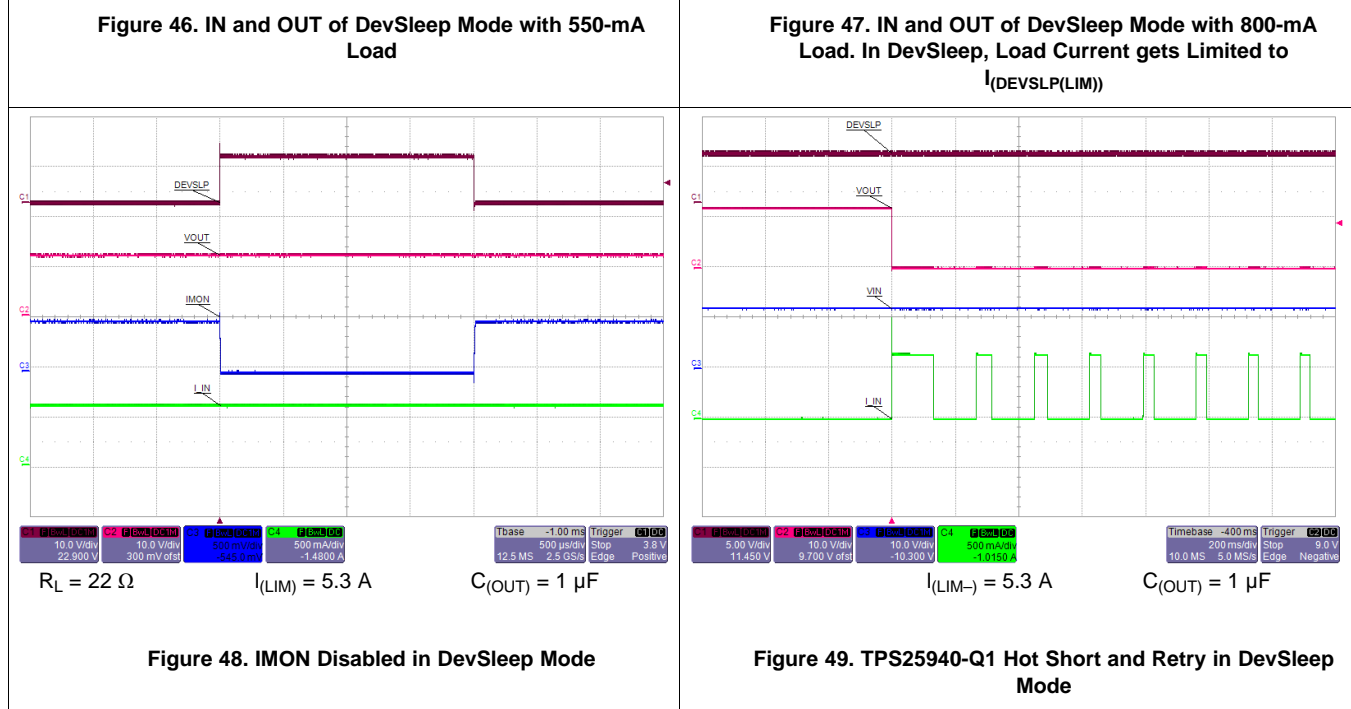
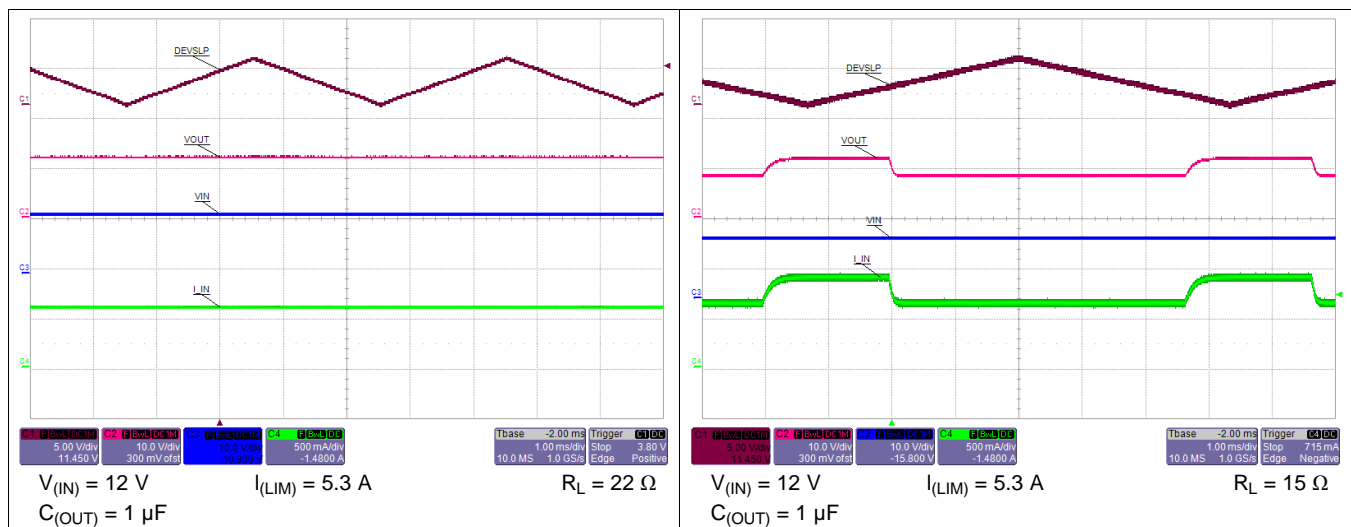

## Device Functional Modes (continued)

### 8.4.2 Shutdown Control

The internal FET and hence the load current can be remotely switched off by taking the UVLO pin below its 0.6 V threshold with an open collector or open drain device as shown in Figure 50. The device quiescent current is reduced to less than 20  $\mu\text{A}$  in this state. Upon releasing the UVLO pin the device turns on with soft-start cycle.

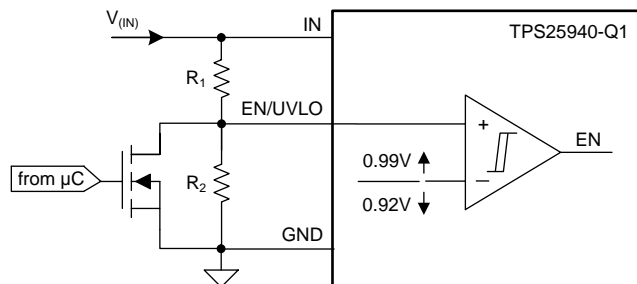

Figure 50. Shutdown Control

## 9 Application and Implementation

### NOTE

Information in the following applications sections is not part of the TI component specification, and TI does not warrant its accuracy or completeness. TI's customers are responsible for determining suitability of components for their purposes. Customers should validate and test their design implementation to confirm system functionality.

### 9.1 Application Information

The TPS25940x-Q1 device is a smart eFuse. It is typically used for Hot-Swap and Power rail protection applications. It operates from 2.7 V to 18 V with programmable current limit, overvoltage and undervoltage protection. The device aids in controlling the in-rush current and provides fast turn-off during reverse voltage conditions for systems such as USB ports prone to Short-to-Battery faults, Servers, Power Back-up Storage units and RAID cards. The device also provides robust protection for multiple faults on the sub-system rail.

The [Detailed Design Procedure](#) section can be used to select component values for the device.

Alternatively, the WEBENCH® software may be used to generate a complete design. The WEBENCH® software uses an iterative design procedure and accesses a comprehensive database of components when generating a design. Additionally, a spreadsheet design tool [TPS25940 Design Calculator](#) is available on web folder.

### 9.2 Typical Application

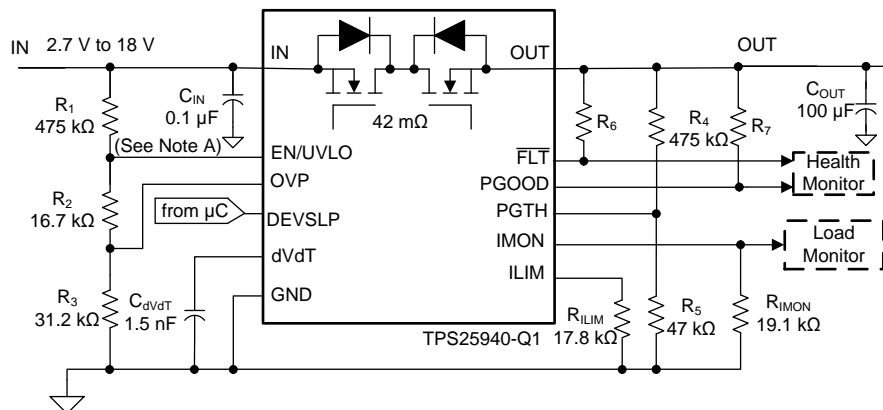

A.  $C_{IN}$ : Optional and only for noise suppression.

**Figure 51. Typical Application Schematic**



## Typical Application (continued)

### 9.2.1 Design Requirements

Table 1 lists the Design Parameters.

**Table 1. Design Parameters**

| DESIGN PARAMETER                            | EXAMPLE VALUE |
|---------------------------------------------|---------------|
| Input voltage, $V_{(IN)}$                   | 12 V          |
| Undervoltage lockout set point, $V_{(UV)}$  | 10.8 V        |
| Overshoot protection set point, $V_{(LIM)}$ | 16.5 V        |
| Load at Start-Up, $R_{L(SU)}$               | 4.8 $\Omega$  |
| Current limit, $I_{(LIM)}$                  | 5 A           |
| Load capacitance, $C_{(OUT)}$               | 100 $\mu$ F   |
| Maximum ambient temperatures, $T_A$         | 85°C          |

### 9.2.2 Detailed Design Procedure

The following design procedure can be used to select component values for the TPS25940x-Q1.

#### 9.2.2.1 Step by Step Design Procedure

To begin the design process a few parameters must be decided upon. The designer must know the following:

- Normal input operation voltage
- Maximum output capacitance
- Maximum current Limit
- Load during start-up
- Maximum ambient temperature of operation

This design procedure below seeks to control the junction temperature of device under both static and transient conditions by proper selection of output ramp-up time and associated support components. The designer can adjust this procedure to fit the application and design criteria.

#### 9.2.2.2 Programming the Current-Limit Threshold: $R_{(ILIM)}$ Selection

The  $R_{(ILIM)}$  resistor at the ILIM pin sets the over load current limit, this can be set using Equation 9.

$$R_{(ILIM)} = \frac{89}{5} = 17.8k\Omega \quad (9)$$

Choose closest standard value: 17.8 k, 1% standard value resistor.

#### 9.2.2.3 Undervoltage Lockout and Overshoot Set Point

The undervoltage lockout (UVLO) and overshoot trip point are adjusted using the external voltage divider network of  $R_1$ ,  $R_2$  and  $R_3$  as connected between IN, EN, OVP and GND pins of the device. The values required for setting the undervoltage and overshoot are calculated solving Equation 10 and Equation 11.

$$V_{(OVPR)} = \frac{R_3}{R_1 + R_2 + R_3} \times V_{(OV)} \quad (10)$$

$$V_{(ENR)} = \frac{R_2 + R_3}{R_1 + R_2 + R_3} \times V_{(UV)} \quad (11)$$

For minimizing the input current drawn from the power supply  $\{I_{(R123)} = V_{(IN)}/(R_1 + R_2 + R_3)\}$ , it is recommended to use higher values of resistance for  $R_1$ ,  $R_2$  and  $R_3$ .

However, leakage currents because of the external active components connected to the resistor string can add error to these calculations. So, the resistor string current,  $I_{(R123)}$  must be chosen to be 20 times greater than the leakage current expected.

From the device electrical specifications,  $V_{(OVPR)} = 0.99$  V and  $V_{(ENR)} = 0.99$  V. For design requirements,  $V_{(OV)}$  is 16.5 V and  $V_{(UV)}$  is 10.8 V. To solve the equation, first choose the value of  $R_3 = 31.2$  k $\Omega$  and use [Equation 10](#) to solve for  $(R_1 + R_2) = 488.8$  k $\Omega$ . Use [Equation 11](#) and value of  $(R_1 + R_2)$  to solve for  $R_2 = 16.47$  k $\Omega$  and finally  $R_1 = 472.33$  k $\Omega$ .

Using the closest standard 1% resistor values gives  $R_1 = 475$  k $\Omega$ ,  $R_2 = 16.7$  k $\Omega$ , and  $R_3 = 31.2$  k $\Omega$ .

The power failure threshold is detected on the falling edge of supply. This threshold voltage is 7% lower than the rising threshold,  $V_{(UV)}$ . This is calculated using [Equation 12](#).

$$V_{(PFAIL)} = 0.93 \times V_{(UV)} \quad (12)$$

#### 9.2.2.4 Programming Current Monitoring Resistor— $R_{(IMON)}$

Voltage at IMON pin  $V_{(IMON)}$  represents the voltage proportional to load current. This can be connected to an ADC of the downstream system for health monitoring of the system. The  $R_{(IMON)}$  need to be configured based on the maximum input voltage range of the ADC used.  $R_{(IMON)}$  is set using [Equation 13](#).

$$R_{(IMON)} = \frac{V_{(IMONmax)}}{I_{(LIM)} \times 52 \times 10^{-6}} \text{ k}\Omega \quad (13)$$

For  $I_{(LIM)} = 5$  A, and considering the operating range of ADC from 0 V to 5 V,  $V_{(IMONmax)}$  is 5 V and  $R_{(IMON)}$  is determined by:

$$R_{(IMON)} = \frac{5}{5 \times 52 \times 10^{-6}} = 19.23 \text{ k}\Omega \quad (14)$$

Selecting  $R_{(IMON)}$  value less than determined by [Equation 14](#) ensures that ADC limits are not exceeded for maximum value of load current.

If the IMON pin voltage is not being digitized with an ADC,  $R_{(IMON)}$  can be selected to produce a 1V/1A voltage at the IMON pin, using [Equation 13](#).

Choose closest 1 % standard value: 19.1 k $\Omega$ .

If current monitoring up to  $I_{(FASTRIP)}$  is desired,  $R_{(IMON)}$  can be reduced by a factor of 1.6, as in [Equation 5](#).

#### 9.2.2.5 Setting Output Voltage Ramp Time ( $t_{dVdT}$ )

For a successful design, the junction temperature of device must be kept below the absolute-maximum rating during both dynamic (start-up) and steady state conditions. Dynamic power stresses often are an order of magnitude greater than the static stresses, so it is important to determine the right start-up time and in-rush current limit required with system capacitance to avoid thermal shutdown during start-up with and without load.

The ramp-up capacitor  $C_{(dVdT)}$  needed is calculated considering the two possible cases [Case1: Start-up Without Load: Only Output Capacitance  \$C\_{\(OUT\)}\$  Draws Current During Start-up](#) and [Case 2: Start-Up With Load: Output Capacitance  \$C\_{\(OUT\)}\$  and Load Draws Current During Start-Up](#).

##### 9.2.2.5.1 Case1: Start-up Without Load: Only Output Capacitance $C_{(OUT)}$ Draws Current During Start-up

During start-up, as the output capacitor charges, the voltage difference across the internal FET decreases, and the power dissipated decreases as well. Typical ramp-up of output voltage  $V_{(OUT)}$  with inrush current limit of 1.2 A and power dissipated in the device during start-up is shown in [Figure 52](#). The average power dissipated in the device during start-up is equal to area of triangular plot (red curve in [Figure 52](#)) averaged over  $t_{dVdT}$ .

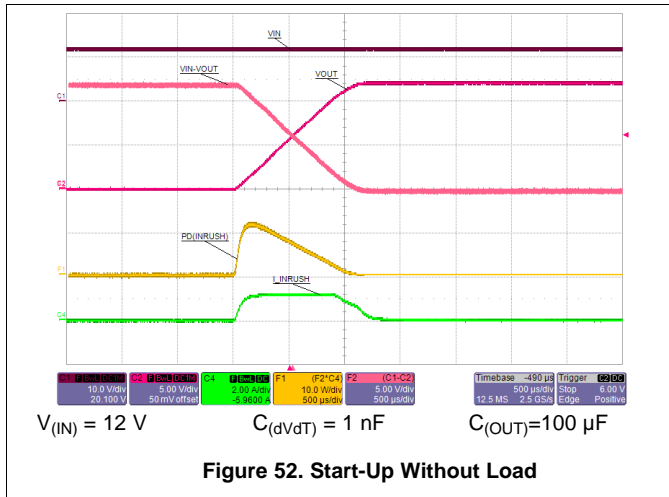

Figure 52. Start-Up Without Load

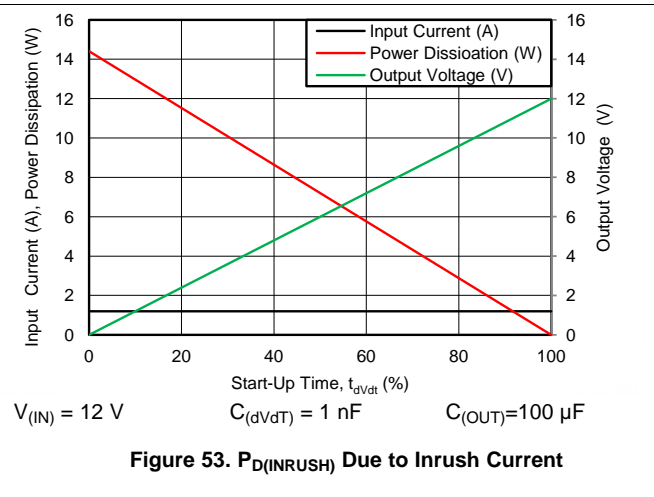

Figure 53.  $P_{D(INRUSH)}$  Due to Inrush Current

For the TPS25940-Q1 device, the inrush current is determined as shown in Equation 15.

$$I = C \times \frac{dV}{dT} \Rightarrow I_{(INRUSH)} = C_{(OUT)} \times \frac{V_{(IN)}}{t_{dVdT}} \quad (15)$$

Power dissipation during start-up is given by Equation 16.

$$P_{D(INRUSH)} = 0.5 \times V_{(IN)} \times I_{(INRUSH)} \quad (16)$$

Equation 16 assumes that load does not draw any current until the output voltage has reached its final value.

#### 9.2.2.5.2 Case 2: Start-Up With Load: Output Capacitance $C_{(OUT)}$ and Load Draws Current During Start-Up

When load draws current during the turn-on sequence, there is additional power dissipated. Considering a resistive load  $R_{L(SU)}$  during start-up, load current ramps up proportionally with increase in output voltage during  $t_{dVdT}$  time. Typical ramp-up of output voltage, Load current and power dissipation in the device is shown in Figure 54 and power dissipation with respect to time is plotted in Figure 55. The additional power dissipation during start-up phase is calculated as shown in Equation 17 and Equation 18.

$$(V_I - V_O)(t) = V_{(IN)} \times \left(1 - \frac{t}{t_{dVdT}}\right) \quad (17)$$

$$I_L(t) = \left(\frac{V_{(IN)}}{R_{L(SU)}}\right) \times \frac{t}{t_{dVdT}} \quad (18)$$

Where  $R_{L(SU)}$  is the load resistance present during start-up. Average energy loss in the internal FET during charging time due to resistive load is given by Equation 19.

$$W_t = \int_0^{t_{dVdT}} V_{(IN)} \times \left(1 - \frac{t}{t_{dVdT}}\right) \times \left(\frac{V_{(IN)}}{R_{L(SU)}} \times \frac{t}{t_{dVdT}}\right) dt \quad (19)$$

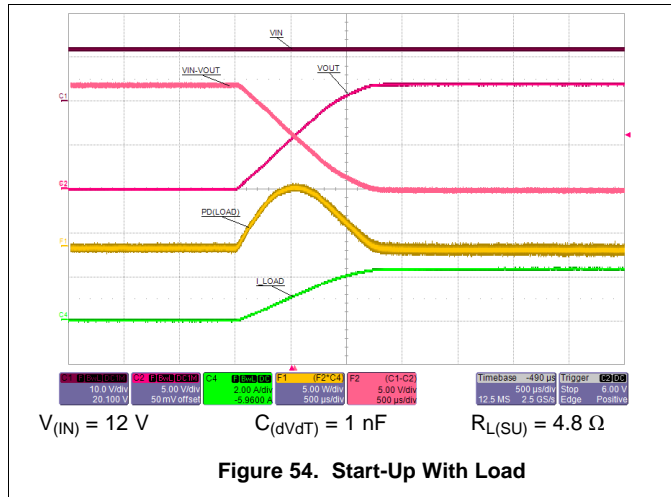

Figure 54. Start-Up With Load

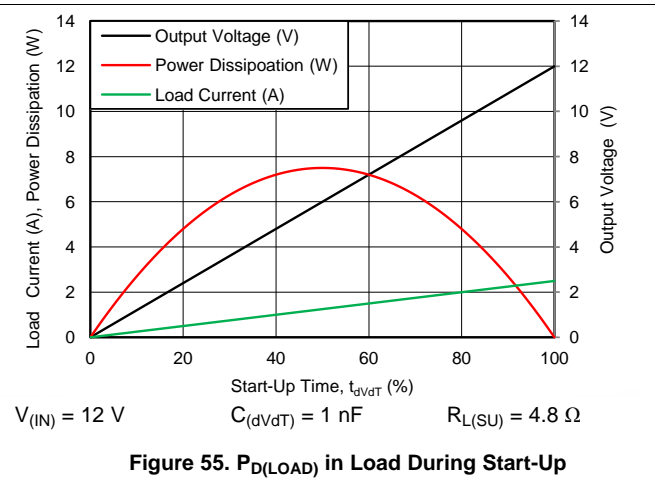

Figure 55.  $P_{D(Load)}$  in Load During Start-Up

On solving Equation 19 the average power loss in the internal FET due to load is shown in Equation 20.

$$P_{D(Load)} = \left(\frac{1}{6}\right) \times \frac{V_{(IN)}^2}{R_{L(SU)}} \tag{20}$$

Total power dissipated in the device during startup is shown in Equation 21.

$$P_{D(STARTUP)} = P_{D(INRUSH)} + P_{D(Load)} \tag{21}$$

Total current during startup is given by Equation 22.

$$I_{(STARTUP)} = I_{(INRUSH)} + I_L(t) \tag{22}$$

If  $I_{(STARTUP)} > I_{(LIM)}$ , the device limits the current to  $I_{(LIM)}$  and the current limited charging time is determined by Equation 23.

$$t_{dVdT(\text{current limited})} = C_{(OUT)} \times \frac{V_{(IN)}}{I_{(LIM)}} \tag{23}$$

The power dissipation, with and without load, for selected start-up time must not exceed the shutdown limits as shown in Figure 56.

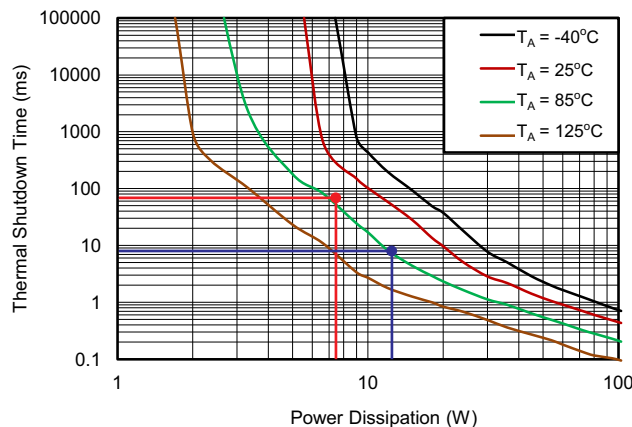

Taken on 2-Layer board, 2oz.(0.08-mm thick) with GND plane area: 14 cm<sup>2</sup> (Top) and 20 cm<sup>2</sup> (bottom)

Figure 56. Thermal Shutdown Limit Plot

For the design example under discussion,

Select ramp-up capacitor  $C_{(dVdT)} = 1\text{nF}$ , using Equation 24.

$$t_{dVdT} = 8.3 \times 10^4 \times 12 \times 1 \times 10^{-9} = 0.996\text{ms} = \sim 1\text{ms} \tag{24}$$

The inrush current drawn by the load capacitance ( $C_{(OUT)}$ ) during ramp-up using Equation 25.

$$I_{(\text{INRUSH})} = (100 \times 10^{-6}) \times \left( \frac{12}{1 \times 10^{-3}} \right) = 1.2 \text{ A} \quad (25)$$

The inrush Power dissipation is calculated, using [Equation 26](#).

$$P_{D(\text{INRUSH})} = 0.5 \times 12 \times 1.2 = 7.2 \text{ W} \quad (26)$$

For 7.2 W of power loss, the thermal shut down time of the device must not be less than the ramp-up time  $t_{dVdT}$  to avoid the false trip at maximum operating temperature. From thermal shutdown limit graph [Figure 56](#) at  $T_A = 85^\circ\text{C}$ , for 7.2 W of power the shutdown time is approximately 60 ms. So it is safe to use 1 ms as start-up time without any load on output.

Considering the start-up with load 4.8  $\Omega$ , the additional power dissipation, when load is present during start up is calculated, using [Equation 27](#).

$$P_{D(\text{LOAD})} = \left( \frac{1}{6} \right) \times \frac{12 \times 12}{4.8} = 5 \text{ W} \quad (27)$$

The total device power dissipation during start up is given by [Equation 28](#).

$$P_{D(\text{STARTUP})} = (7.2 + 5) = 12.2 \text{ W} \quad (28)$$

From thermal shutdown limit graph at  $T_A = 85^\circ\text{C}$ , the thermal shutdown time for 12.2 W is close to 7.5 ms. It is safe to have 30% margin to allow for variation of system parameters such as load, component tolerance, and input voltage. So it is well within acceptable limits to use the 1 nF capacitor with start-up load of 4.8  $\Omega$ .

If there is a need to decrease the power loss during start-up, it can be done with increase of  $C_{(dVdT)}$  capacitor.

To illustrate, choose  $C_{(dVdT)} = 1.5 \text{ nF}$  as an option and recalculate:

$$t_{dVdT} = 1.5 \text{ ms} \quad (29)$$

$$I_{(\text{INRUSH})} = (100 \times 10^{-6}) \times \left( \frac{12}{1.5 \times 10^{-3}} \right) = 0.8 \text{ A} \quad (30)$$

$$P_{D(\text{INRUSH})} = 0.5 \times 12 \times 0.8 = 4.8 \text{ W} \quad (31)$$

$$P_{D(\text{LOAD})} = \left( \frac{1}{6} \right) \times \left( \frac{12 \times 12}{4.8} \right) = 5 \text{ W} \quad (32)$$

$$P_{D(\text{STARTUP})} = 4.8 + 5 = 9.8 \text{ W} \quad (33)$$

From thermal shutdown limit graph at  $T_A = 85^\circ\text{C}$ , the shutdown time for 10 W power dissipation is approximately 17 ms, which increases the margins further for shutdown time and ensures successful operation during start up and steady state conditions.

The spreadsheet tool available on the web can be used for iterative calculations.

### 9.2.2.6 Programming the Power Good Set Point

As shown in [Figure 51](#),  $R_4$  and  $R_5$  sets the required limit for PGOOD signal as needed for the downstream converters. Considering a power good threshold of 11 V for this design, the values of  $R_4$  and  $R_5$  are calculated using [Equation 34](#).

$$V_{(\text{PGTH})} = 0.99 \times \left( 1 + \frac{R_4}{R_5} \right) \quad (34)$$

It is recommended to have high values for these resistors to limit the current drawn from the output node. Choosing a value of  $R_4 = 475 \text{ k}\Omega$ ,  $R_5 = 47 \text{ k}\Omega$  provides  $V_{(\text{PGTH})} = 11 \text{ V}$ .

### 9.2.2.7 Support Component Selections— $R_6$ , $R_7$ and $C_{IN}$

Reference to application schematics,  $R_6$  and  $R_7$  are required only if PGOOD and  $\overline{\text{FLT}}$  are used; these resistors serve as pull-ups for the open-drain output drivers. The current sunk by each of these pins must not exceed 10 mA (refer to the [Absolute Maximum Ratings](#) table).  $C_{IN}$  is a bypass capacitor to help control transient voltages, unit emissions, and local supply noise. Where acceptable, a value in the range of 0.001  $\mu\text{F}$  to 0.1  $\mu\text{F}$  is recommended for  $C_{(\text{IN})}$ .

9.2.3 Application Curves

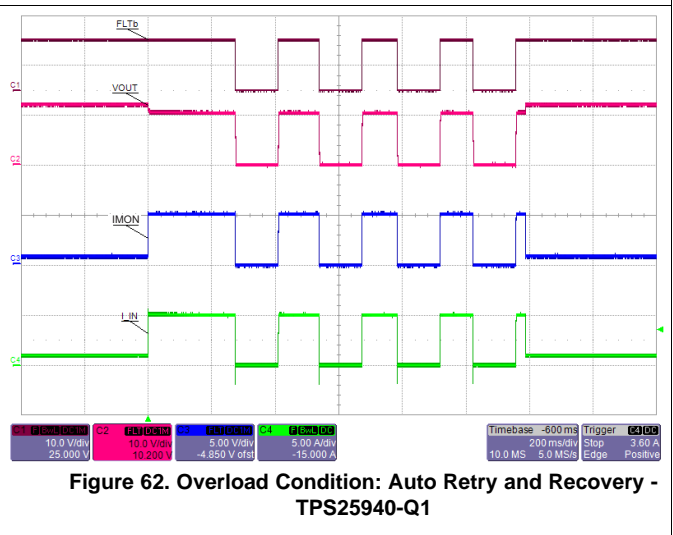
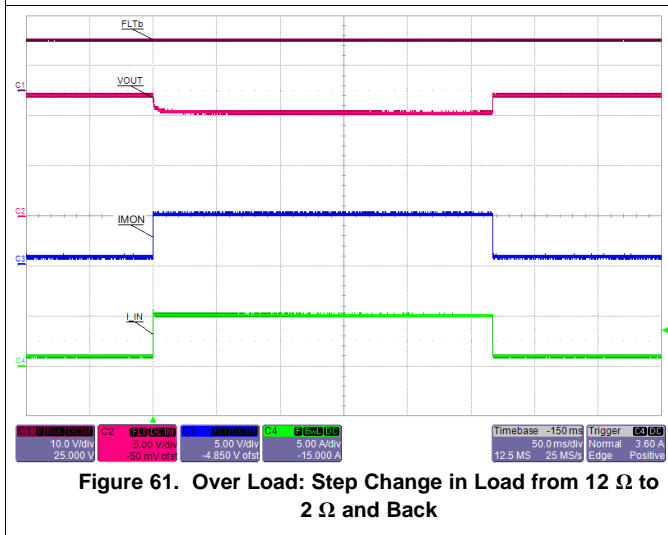
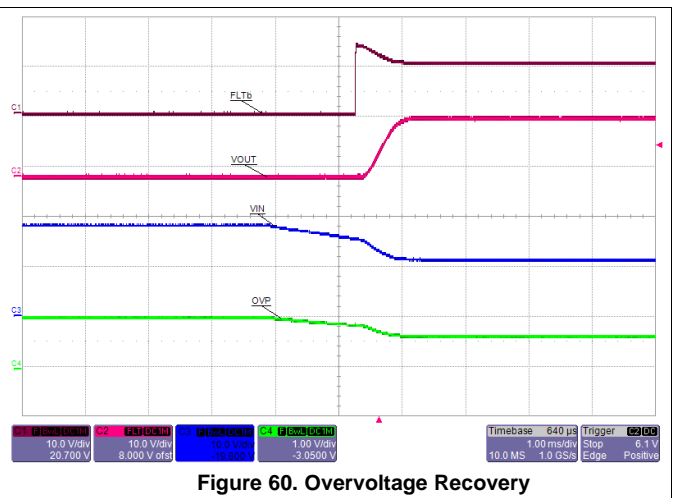
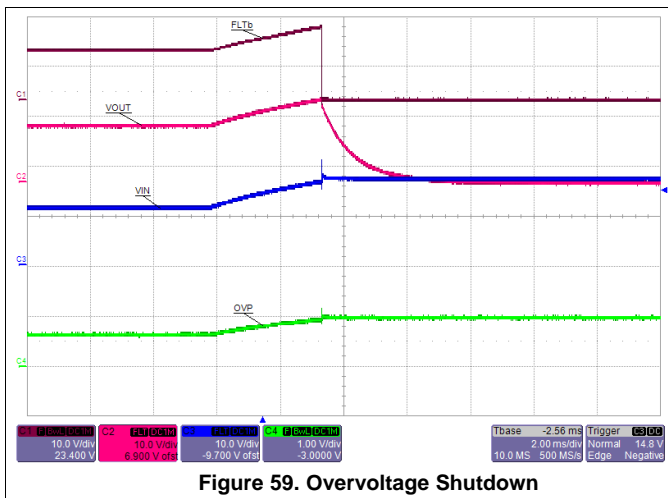
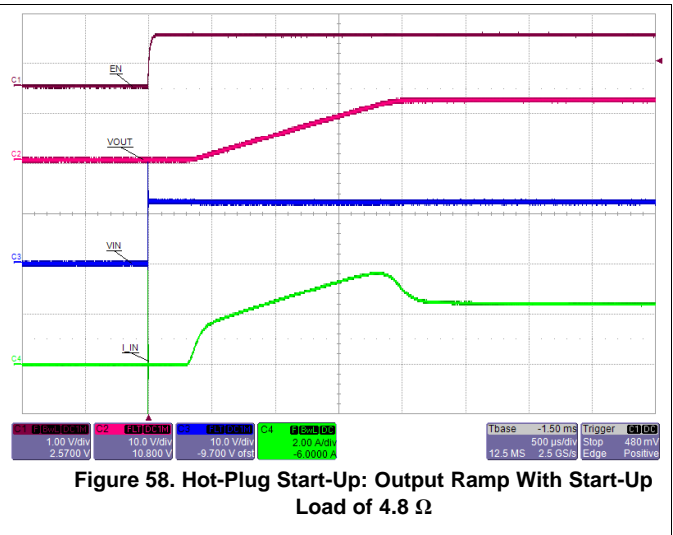
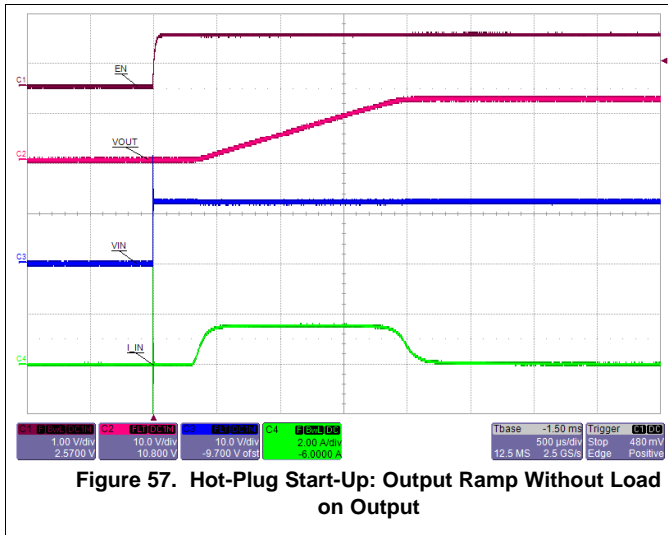

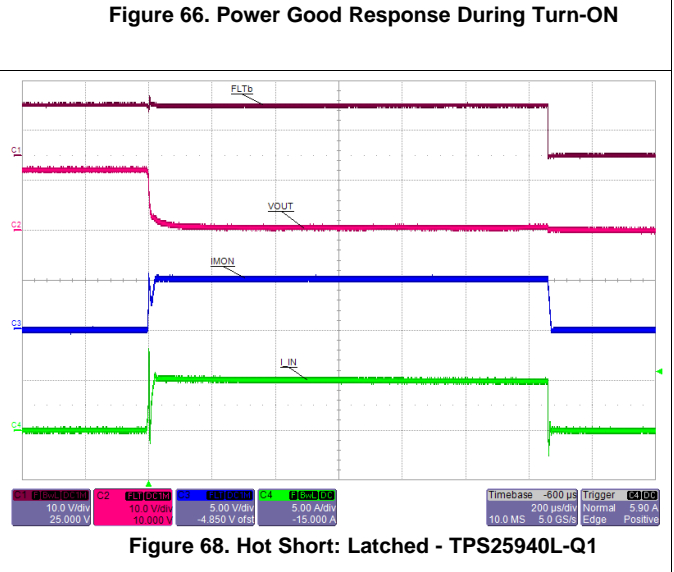
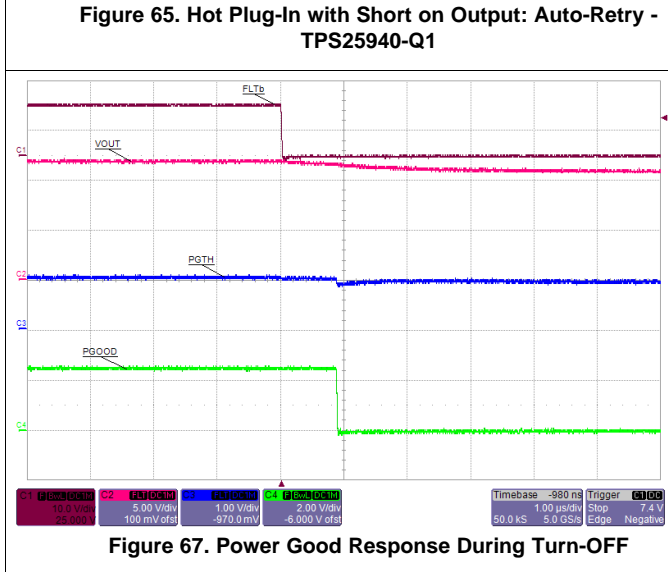
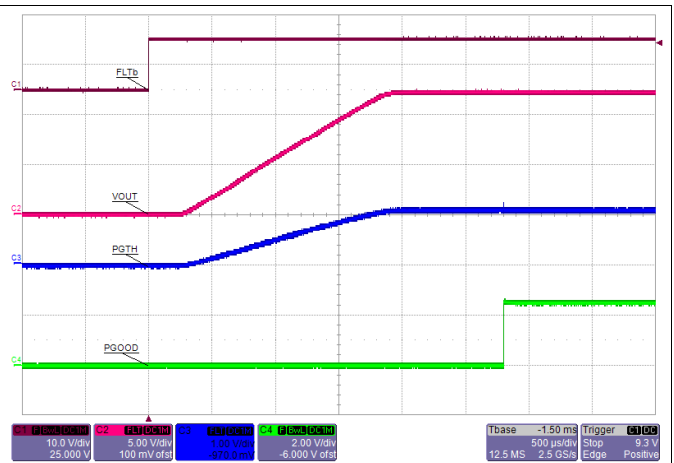
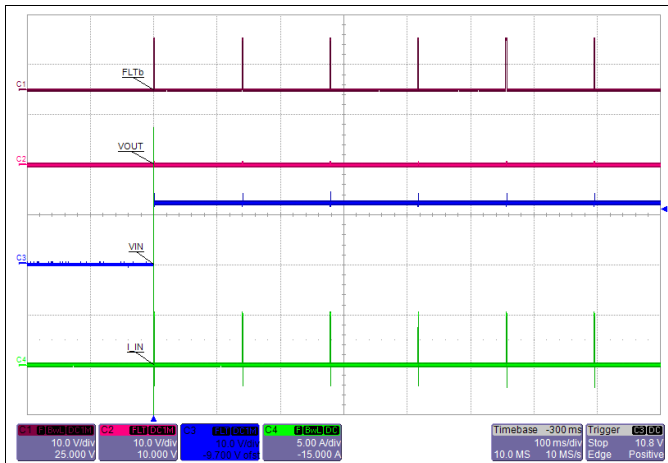
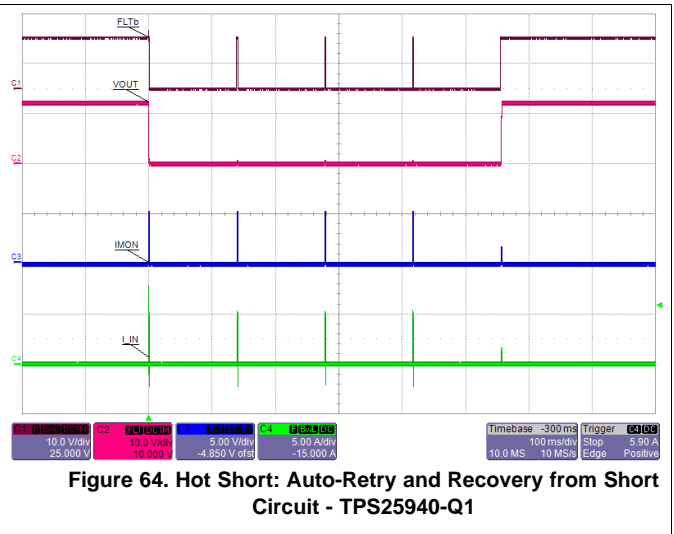
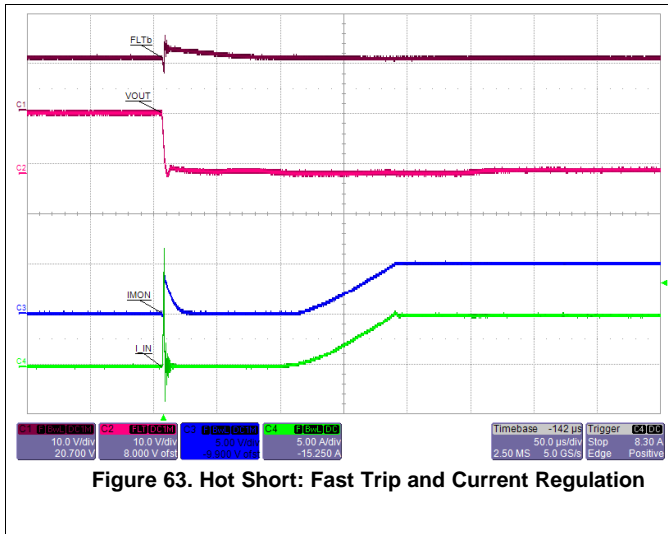

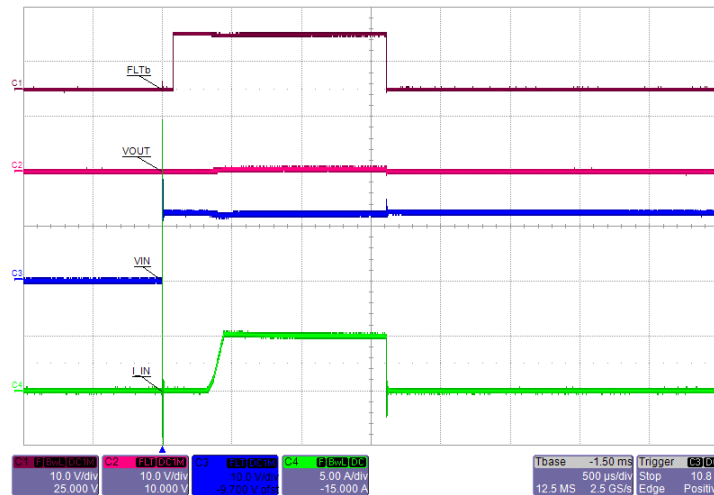

Figure 69. Hot Plug-in with Short on Output: Latched - TPS25940L-Q1

## 9.2.4 System Examples

### 9.2.4.1 $V_{BUS}$ Short-to-Battery, Short-to-Ground Protection of USB Port in Automotive Systems

The TPS25940x-Q1 eFuse offers robust protection for the 5 V Power rail of USB ports under faults conditions like Short-to-Ground, Short-to-Battery and Overload.

5-V Power rail gets disconnected from the output within approximately 200 nsec during short circuit to Ground fault.

The eFuse monitors the reverse voltage from IN to OUT and when it exceeds  $-66$  mV, it stops the flow of reverse current. This operation protects the 5-V power rail from Short-to-Battery faults.

Typical application schematic of TPS25940x-Q1 usage in USB port protection for automotive application is shown in Figure 70.

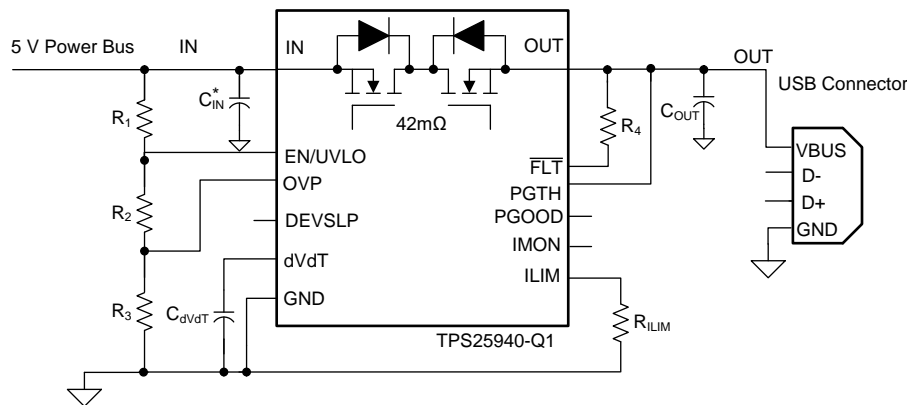

Figure 70. Automotive USB Hub-Port –  $V_{BUS}$  Short to Battery,  $V_{BUS}$  Short to GND Protection

Figure 71 and Figure 72 show the performance of TPS25940-Q1 under Short-to-Battery and Short-to-Ground faults.



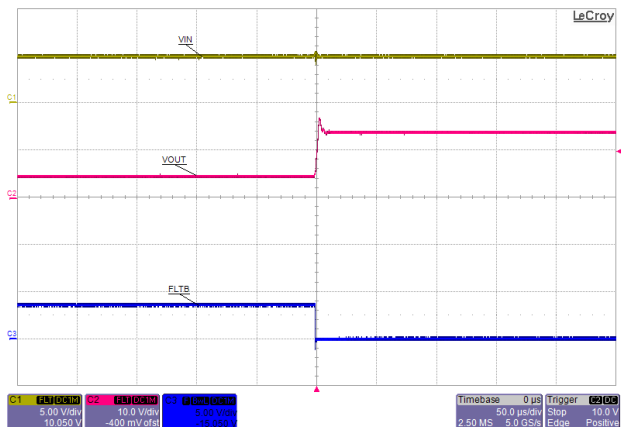

Figure 71.  $V_{BUS}$  Short-to-Battery Protection

$V_{(IN)} = 5\text{ V}$

$C_{(OUT)} = 4.7\ \mu\text{F}$

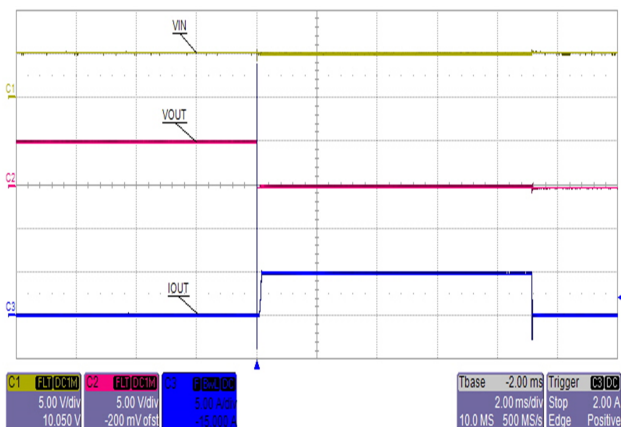

Figure 72.  $V_{BUS}$  Short-to-Ground Protection

**9.2.4.2 Power Failure Protection for Holdup Power**

For certain applications, it is necessary to have hold-up circuit and capacitor bank to ensure that critical user data is never lost during power-failure to the drive. The power-failure event could be because of the momentary loss of power regulation (transient brown-out condition) or because of the loss of power when system is hot-plugged out.

The TPS25940x-Q1 device continuously monitors the supply voltage at EN/UVLO pin and swiftly disconnects the input bus from output when the voltage drops below a predefined threshold (power fail detection). Reverse current flow from output side to input supply gets blocked when reverse voltage from IN to OUT exceeds  $-66\text{ mV}$ . In addition, it provides an instant warning signal ( $\overline{FLT}$ ) to the controller. Its swift true reverse blocking feature reacts in  $1\ \mu\text{s}$  (typical) ensuring that the capacitor bank charge is retained. This helps the drive to have power for longer time to harden data and reduces the capacitance required in the hold-up bank, saving system cost.

The typical application diagram of TPS25940x-Q1 usage for holdup power is shown in [Figure 73](#).

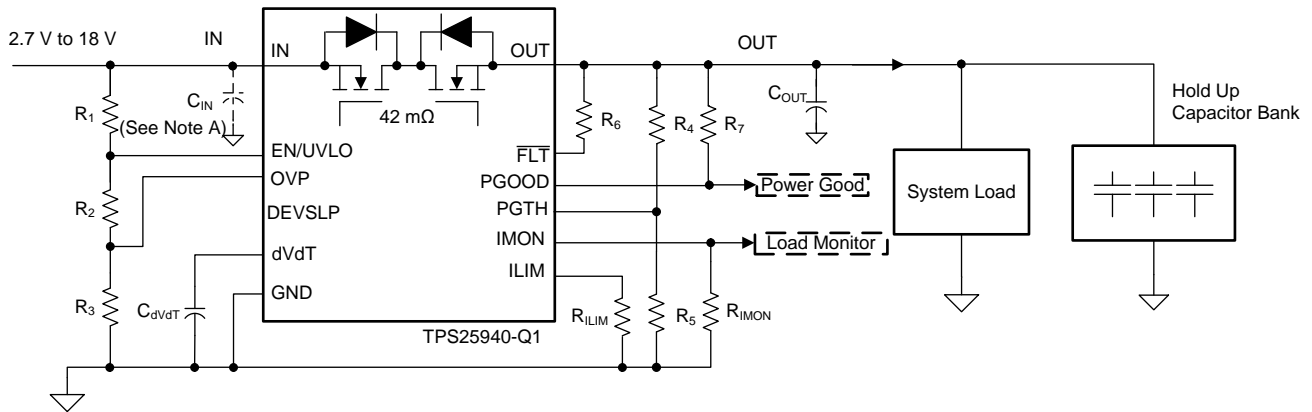

A.  $C_{IN}$ : Optional and only for noise suppression.

Figure 73. Holdup Capacitor Implementation Using TPS25940-Q1

The oscilloscope plots demonstrating the true reverse blocking, fast turn-off and  $\overline{FLT}$  signal delay are shown in Figure 74 through Figure 76.

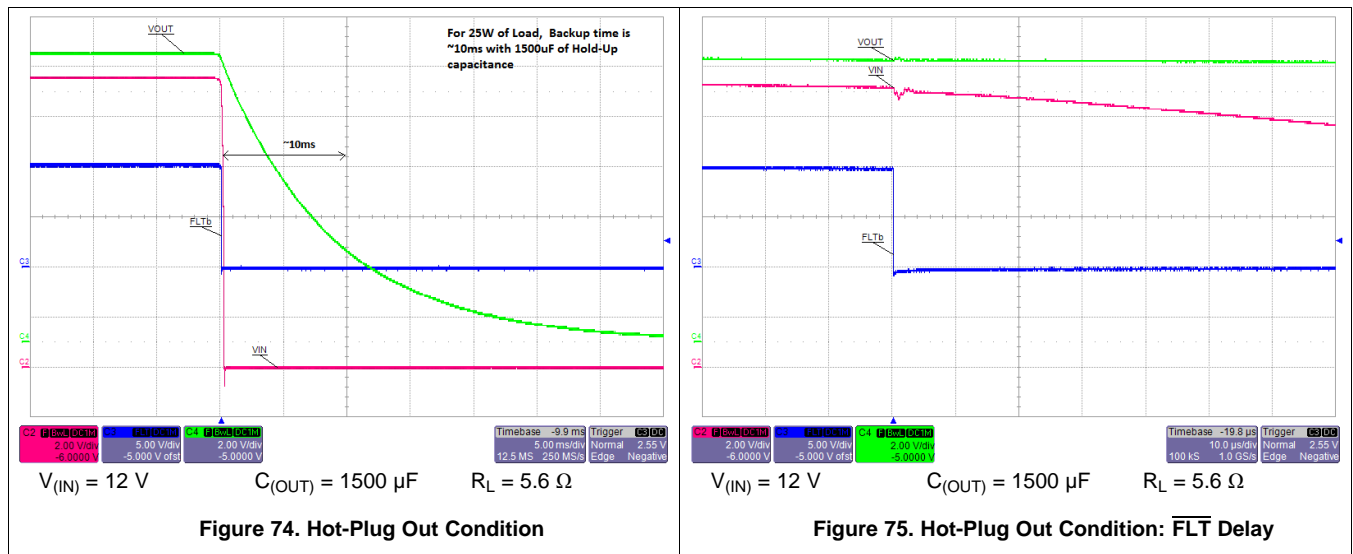

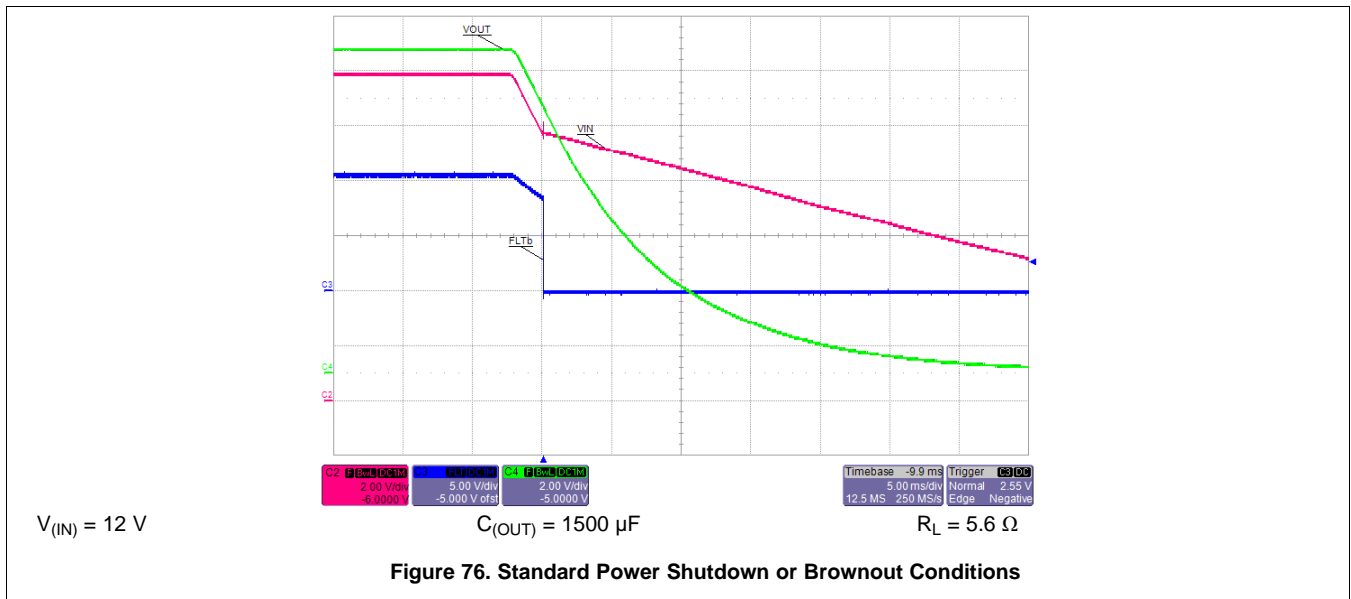

### 9.2.4.3 Overload Detection Using TPS25940x-Q1

The TPS25940x-Q1 device has enhanced features such as load current monitoring output IMON and an integrated power good comparator for voltage monitoring. These two functional blocks can be utilized as per circuit configuration shown in Figure 77, to FLAG the overload event.

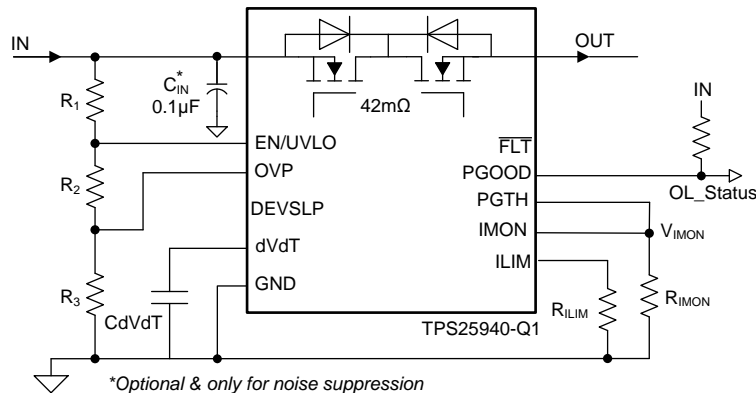

**Figure 77. Circuit Configuration for Overload Detection Using TPS25940-Q1**

The output voltage at IMON terminal  $V_{IMON}$  can be used as a means of monitoring current flow through the system and its value can be calculated from Equation 6.

The power good comparator of TPS25940x-Q1 has an internal reference of  $V_{PGTHR} = 0.99\text{ V}$  at the negative terminal and the positive terminal PGTH can be utilized for monitoring voltage of any specific rail. As shown in the Figure 77, the output voltage at IMON terminal ( $V_{IMON}$ ) is fed to the positive terminal PGTH ( $V_{PGTH}$ ) of the comparator. When the PGTH pin voltage ( $V_{PGTH} = V_{IMON}$ ) is higher than the internal reference  $V_{PGTHR}$ , the open-drain comparator output PGOOD asserts HIGH to indicate overload event.

For example, to detect overcurrent event at load current  $I_{OUT}$  of 300 mA, the value of  $R_{IMON}$  can be calculated using Equation 35.

$$V_{IMON} = V_{PGTHR} = (I_{OUT} \times GAIN_{IMON} + I_{IMON\_OS}) \times R_{IMON} \tag{35}$$

$$R_{IMON} = \frac{V_{PGTHR}}{(I_{OUT} \times GAIN_{IMON} + I_{IMON\_OS})} = \frac{0.99 \text{ V}}{\left(300 \text{ mA} \times 52 \frac{\mu\text{A}}{\text{A}} + 0.8 \mu\text{A}\right)} = 60.36 \text{ k}\Omega \quad (36)$$

A close value of 61.9 kΩ is chosen for R<sub>IMON</sub>.

Figure 78 shows the overload flag status when the load is changed from 150 mA to 600 mA and back. As seen in the Figure 78, the overload status (OL\_Status) becomes active HIGH when the load current crosses 300 mA.

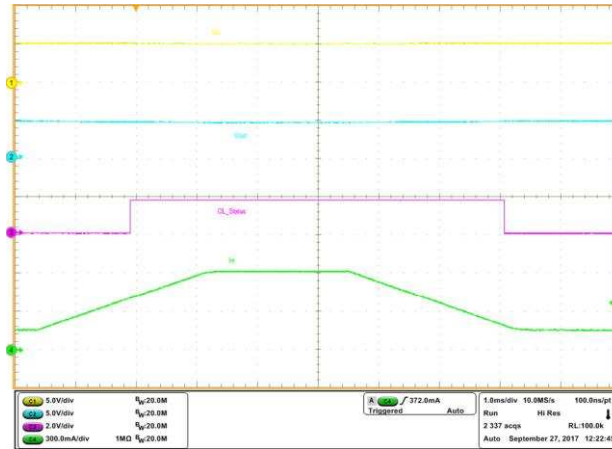

Figure 78. Overload Flag Status for Change in Load from 150 mA to 600 mA and Back

## 10 Power Supply Recommendations

The TPS25940x-Q1 device is designed for supply voltage range of  $2.7\text{ V} \leq V_{\text{IN}} \leq 18\text{ V}$ . If the input supply is located more than a few inches from the device an input ceramic bypass capacitor higher than  $0.1\text{ }\mu\text{F}$  is recommended. Power supply must be rated higher than the current limit set to avoid voltage droops during over current and short-circuit conditions.

### 10.1 Transient Protection

In case of short circuit and over load current limit, when the device interrupts current flow, input inductance generates a positive voltage spike on the input and output inductance generates a negative voltage spike on the output. The peak amplitude of voltage spikes (transients) is dependent on value of inductance in series to the input or output of the device. In case of sudden Output short-to-Battery faults with a long external cable, the cable inductance and output capacitance generates over voltage spike at the output. Such transients can exceed the [Absolute Maximum Ratings](#) of the device if steps are not taken to address the issue.

Typical methods for addressing transients include

- Minimizing lead length and inductance into and out of the device
- Using large PCB GND plane
- A 18-V TVS across output to GND to absorb positive spikes. Schottky diode across the output to absorb negative spikes
- A low value ceramic capacitor ( $C_{\text{IN}} = 0.001\text{ }\mu\text{F}$  to  $0.1\text{ }\mu\text{F}$ ) to absorb the energy and dampen the transients. The approximate value of input capacitance can be estimated with [Equation 37](#).

$$V_{\text{SPIKE(Absolute)}} = V_{\text{(IN)}} + I_{\text{(LOAD)}} \times \sqrt{\frac{L_{\text{(IN)}}}{C_{\text{(IN)}}}}$$

where

- $V_{\text{(IN)}}$  is the nominal supply voltage
  - $I_{\text{(LOAD)}}$  is the load current,
  - $L_{\text{(IN)}}$  equals the effective inductance seen looking into the source
  - $C_{\text{(IN)}}$  is the capacitance present at the input
- (37)

Some applications may require the addition of a Transient Voltage Suppressor (TVS) to prevent transients from exceeding the [Absolute Maximum Ratings](#) of the device.

The circuit implementation with optional protection components (a ceramic capacitor, TVS and schottky diode) is shown in [Figure 79](#).

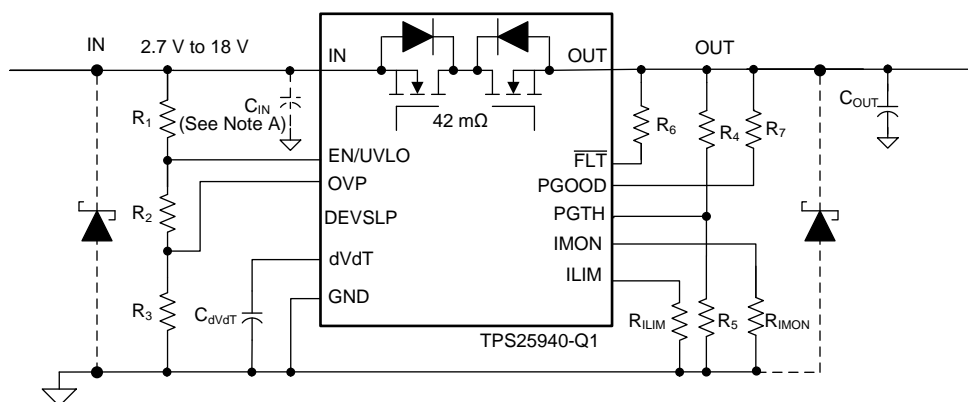

A. Optional components needed for suppression of transients

**Figure 79. Circuit Implementation with Optional Protection Components**

## 10.2 Output Short-Circuit Measurements

It is difficult to obtain repeatable and similar short-circuit testing results. Source bypassing, input leads, circuit layout and component selection, output shorting method, relative location of the short, and instrumentation all contribute to variation in results. The actual short itself exhibits a certain degree of randomness as it microscopically bounces and arcs. Care in configuration and methods must be used to obtain realistic results. Do not expect to see waveforms exactly like those in the data sheet; every setup differs.

## 11 Layout

### 11.1 Layout Guidelines

- For all applications, a 0.1- $\mu$ F or greater ceramic decoupling capacitor is recommended between IN terminal and GND. For hot-plug applications, where input power path inductance is negligible, this capacitor can be eliminated/minimized.
- The optimum placement of decoupling capacitor is closest to the IN and GND terminals of the device. Care must be taken to minimize the loop area formed by the bypass-capacitor connection, the IN terminal, and the GND terminal of the IC. See [Figure 80](#) for a PCB layout example.
- High current carrying power path connections must be as short as possible and must be sized to carry at least twice the full-load current.
- Low current signal ground (SGND), which is the reference ground for the device must be a copper plane or island.
- Locate all TPS25940x-Q1 support components:  $R_{(ILIM)}$ ,  $C_{dVdT}$ ,  $R_{(IMON)}$ , and resistors for UVLO and OVP, close to their connection pin. Connect the other end of the component to the SGND with shortest trace length.
- The trace routing for the  $R_{ILIM}$  and  $R_{(IMON)}$  components to the device must be as short as possible to reduce parasitic effects on the current limit and current monitoring accuracy. These traces must not have any coupling to switching signals on the board.
- The SGND plane must be connected to high current ground (main power ground) at a single point, that is at the negative terminal of input capacitor.
- Protection devices such as TVS, snubbers, capacitors, or diodes must be placed physically close to the device they are intended to protect, and routed with short traces to reduce inductance. For example, a protection Schottky diode is recommended to address negative transients due to switching of inductive loads, and it must be physically close to the OUT pins.
- Thermal Considerations: When properly mounted the PowerPAD™ package provides significantly greater cooling ability than an ordinary package. To operate at rated power, the PowerPAD must be soldered directly to the board GND plane directly under the device. The PowerPAD is at GND potential and can be connected using multiple vias to inner layer GND. Other planes, such as the bottom side of the circuit board can be used to increase heat sinking in higher current applications. See the Technical Briefs, PowerPad™ Thermally Enhanced Package, [SLMA002](#)) and PowerPAD™ Made Easy, [SLMA004](#)) for more information on using this PowerPAD™ package.
- The thermal via land pattern specific to TPS25940x-Q1 can be downloaded from the TPS25940 [device webpage](#).
- Obtaining acceptable performance with alternate layout schemes is possible; however this layout has been shown to produce good results and is intended as a guideline.

## 11.2 Layout Example

- Top layer
- Top layer signal ground plane
- Bottom layer signal ground plane
- Via to signal ground plane

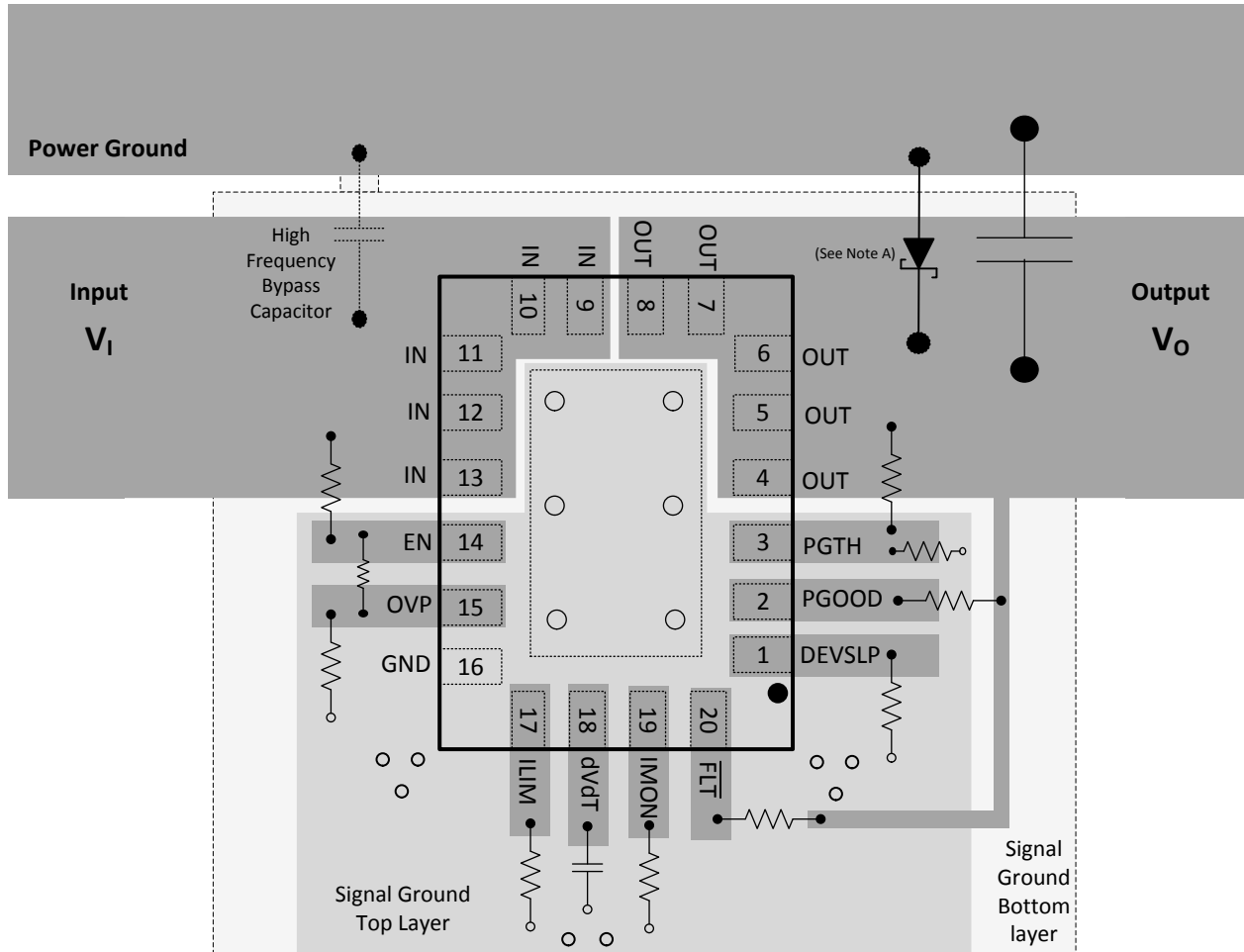

A. Optional: Needed only to suppress the transients caused by inductive load switching

**Figure 80. Board Layout**



## 12 Device and Documentation Support

### 12.1 Documentation Support

#### 12.1.1 Related Documentation

For related documetation see the following:

- *High-Efficiency Backup Power Supply*, [SLVA676](#)
- *TPS25940 Evaluation Module User's Guide*, [SLVUA44](#)

### 12.2 Community Resources

The following links connect to TI community resources. Linked contents are provided "AS IS" by the respective contributors. They do not constitute TI specifications and do not necessarily reflect TI's views; see TI's [Terms of Use](#).

**TI E2E™ Online Community** *TI's Engineer-to-Engineer (E2E) Community*. Created to foster collaboration among engineers. At [e2e.ti.com](#), you can ask questions, share knowledge, explore ideas and help solve problems with fellow engineers.

**Design Support** *TI's Design Support* Quickly find helpful E2E forums along with design support tools and contact information for technical support.

### 12.3 Trademarks

E2E is a trademark of Texas Instruments.

All other trademarks are the property of their respective owners.

### 12.4 Electrostatic Discharge Caution



These devices have limited built-in ESD protection. The leads should be shorted together or the device placed in conductive foam during storage or handling to prevent electrostatic damage to the MOS gates.

### 12.5 Glossary

[SLYZ022](#) — *TI Glossary*.

This glossary lists and explains terms, acronyms, and definitions.

## 13 Mechanical, Packaging, and Orderable Information

The following pages include mechanical, packaging, and orderable information. This information is the most current data available for the designated devices. This data is subject to change without notice and revision of this document. For browser-based versions of this data sheet, refer to the left-hand navigation.

**PACKAGING INFORMATION**

| Orderable Device  | Status<br>(1) | Package Type | Package<br>Drawing | Pins | Package<br>Qty | Eco Plan<br>(2)            | Lead/Ball Finish<br>(6) | MSL Peak Temp<br>(3) | Op Temp (°C) | Device Marking<br>(4/5) | Samples                 |
|-------------------|---------------|--------------|--------------------|------|----------------|----------------------------|-------------------------|----------------------|--------------|-------------------------|-------------------------|
| TPS25940AQRVCRQ1  | ACTIVE        | WQFN         | RVC                | 20   | 3000           | Green (RoHS<br>& no Sb/Br) | CU NIPDAU               | Level-2-260C-1 YEAR  | -40 to 125   | 2594AQ                  | <a href="#">Samples</a> |
| TPS25940AQRVCTQ1  | ACTIVE        | WQFN         | RVC                | 20   | 250            | Green (RoHS<br>& no Sb/Br) | CU NIPDAU               | Level-2-260C-1 YEAR  | -40 to 125   | 2594AQ                  | <a href="#">Samples</a> |
| TPS25940LQVRVCRQ1 | ACTIVE        | WQFN         | RVC                | 20   | 3000           | Green (RoHS<br>& no Sb/Br) | CU NIPDAU               | Level-2-260C-1 YEAR  | -40 to 125   | T594LQ                  | <a href="#">Samples</a> |

(1) The marketing status values are defined as follows:

**ACTIVE:** Product device recommended for new designs.

**LIFEBUY:** TI has announced that the device will be discontinued, and a lifetime-buy period is in effect.

**NRND:** Not recommended for new designs. Device is in production to support existing customers, but TI does not recommend using this part in a new design.

**PREVIEW:** Device has been announced but is not in production. Samples may or may not be available.

**OBSOLETE:** TI has discontinued the production of the device.

(2) **RoHS:** TI defines "RoHS" to mean semiconductor products that are compliant with the current EU RoHS requirements for all 10 RoHS substances, including the requirement that RoHS substance do not exceed 0.1% by weight in homogeneous materials. Where designed to be soldered at high temperatures, "RoHS" products are suitable for use in specified lead-free processes. TI may reference these types of products as "Pb-Free".

**RoHS Exempt:** TI defines "RoHS Exempt" to mean products that contain lead but are compliant with EU RoHS pursuant to a specific EU RoHS exemption.

**Green:** TI defines "Green" to mean the content of Chlorine (Cl) and Bromine (Br) based flame retardants meet JS709B low halogen requirements of <=1000ppm threshold. Antimony trioxide based flame retardants must also meet the <=1000ppm threshold requirement.

(3) MSL, Peak Temp. - The Moisture Sensitivity Level rating according to the JEDEC industry standard classifications, and peak solder temperature.

(4) There may be additional marking, which relates to the logo, the lot trace code information, or the environmental category on the device.

(5) Multiple Device Markings will be inside parentheses. Only one Device Marking contained in parentheses and separated by a "~" will appear on a device. If a line is indented then it is a continuation of the previous line and the two combined represent the entire Device Marking for that device.

(6) Lead/Ball Finish - Orderable Devices may have multiple material finish options. Finish options are separated by a vertical ruled line. Lead/Ball Finish values may wrap to two lines if the finish value exceeds the maximum column width.

**Important Information and Disclaimer:** The information provided on this page represents TI's knowledge and belief as of the date that it is provided. TI bases its knowledge and belief on information provided by third parties, and makes no representation or warranty as to the accuracy of such information. Efforts are underway to better integrate information from third parties. TI has taken and continues to take reasonable steps to provide representative and accurate information but may not have conducted destructive testing or chemical analysis on incoming materials and chemicals. TI and TI suppliers consider certain information to be proprietary, and thus CAS numbers and other limited information may not be available for release.

In no event shall TI's liability arising out of such information exceed the total purchase price of the TI part(s) at issue in this document sold by TI to Customer on an annual basis.

**OTHER QUALIFIED VERSIONS OF TPS25940-Q1 :**

- Catalog: [TPS25940](#)

NOTE: Qualified Version Definitions:

- Catalog - TI's standard catalog product

**TAPE AND REEL INFORMATION**

**QUADRANT ASSIGNMENTS FOR PIN 1 ORIENTATION IN TAPE**

\*All dimensions are nominal

| Device           | Package Type | Package Drawing | Pins | SPQ  | Reel Diameter (mm) | Reel Width W1 (mm) | A0 (mm) | B0 (mm) | K0 (mm) | P1 (mm) | W (mm) | Pin1 Quadrant |
|------------------|--------------|-----------------|------|------|--------------------|--------------------|---------|---------|---------|---------|--------|---------------|
| TPS25940AQRVCRQ1 | WQFN         | RVC             | 20   | 3000 | 330.0              | 12.4               | 3.3     | 4.3     | 1.1     | 8.0     | 12.0   | Q1            |
| TPS25940AQRVCTQ1 | WQFN         | RVC             | 20   | 250  | 180.0              | 12.4               | 3.3     | 4.3     | 1.1     | 8.0     | 12.0   | Q1            |
| TPS25940LQRVCRQ1 | WQFN         | RVC             | 20   | 3000 | 330.0              | 12.4               | 3.3     | 4.3     | 1.1     | 8.0     | 12.0   | Q1            |

**TAPE AND REEL BOX DIMENSIONS**

\*All dimensions are nominal

| Device           | Package Type | Package Drawing | Pins | SPQ  | Length (mm) | Width (mm) | Height (mm) |
|------------------|--------------|-----------------|------|------|-------------|------------|-------------|
| TPS25940AQRVCRQ1 | WQFN         | RVC             | 20   | 3000 | 367.0       | 367.0      | 35.0        |
| TPS25940AQRVCTQ1 | WQFN         | RVC             | 20   | 250  | 210.0       | 185.0      | 35.0        |
| TPS25940LQRVCRQ1 | WQFN         | RVC             | 20   | 3000 | 367.0       | 367.0      | 35.0        |

## GENERIC PACKAGE VIEW

RVC 20

WQFN - 0.8 mm max height

PLASTIC QUAD FLATPACK - NO LEAD

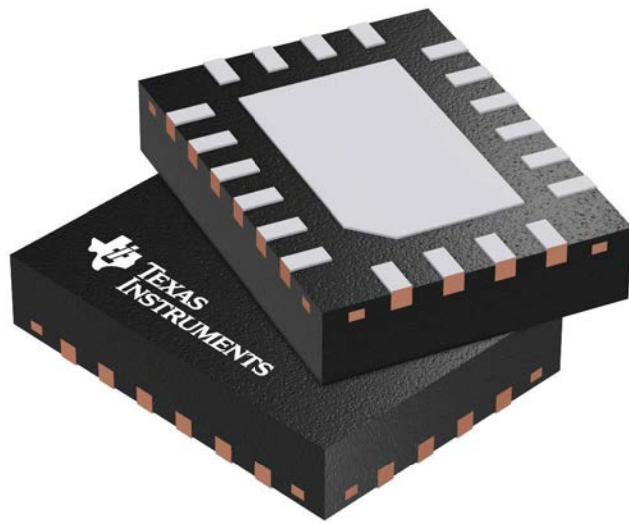

Images above are just a representation of the package family, actual package may vary.  
Refer to the product data sheet for package details.

4209819/B



# EXAMPLE BOARD LAYOUT

RVC0020A

WQFN - 0.8 mm max height

PLASTIC QUAD FLATPACK - NO LEAD

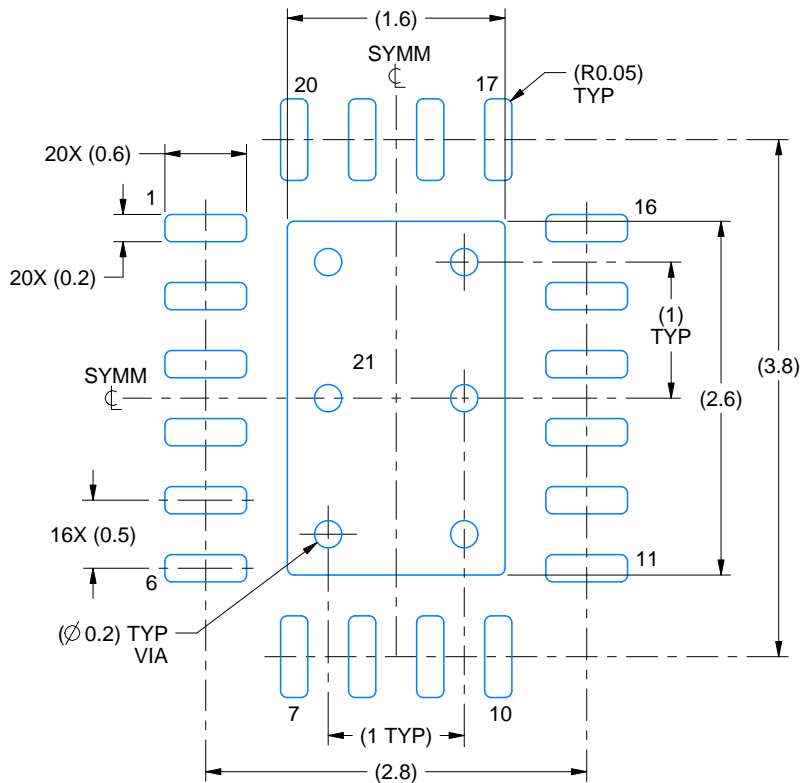

LAND PATTERN EXAMPLE  
EXPOSED METAL SHOWN  
SCALE:18X

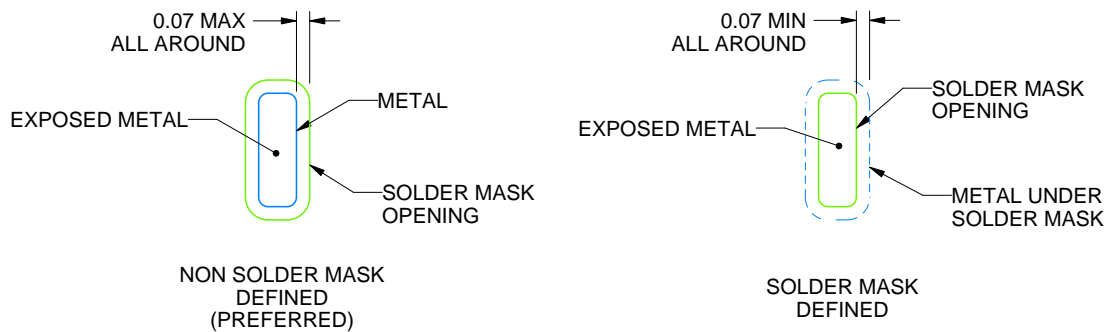

SOLDER MASK DETAILS

4219150/B 03/2017

NOTES: (continued)

4. This package is designed to be soldered to a thermal pad on the board. For more information, see Texas Instruments literature number SLUA271 ([www.ti.com/lit/slua271](http://www.ti.com/lit/slua271)).
5. Vias are optional depending on application, refer to device data sheet. If any vias are implemented, refer to their locations shown on this view. It is recommended that vias under paste be filled, plugged or tented.



# EXAMPLE STENCIL DESIGN

RVC0020A

WQFN - 0.8 mm max height

PLASTIC QUAD FLATPACK - NO LEAD

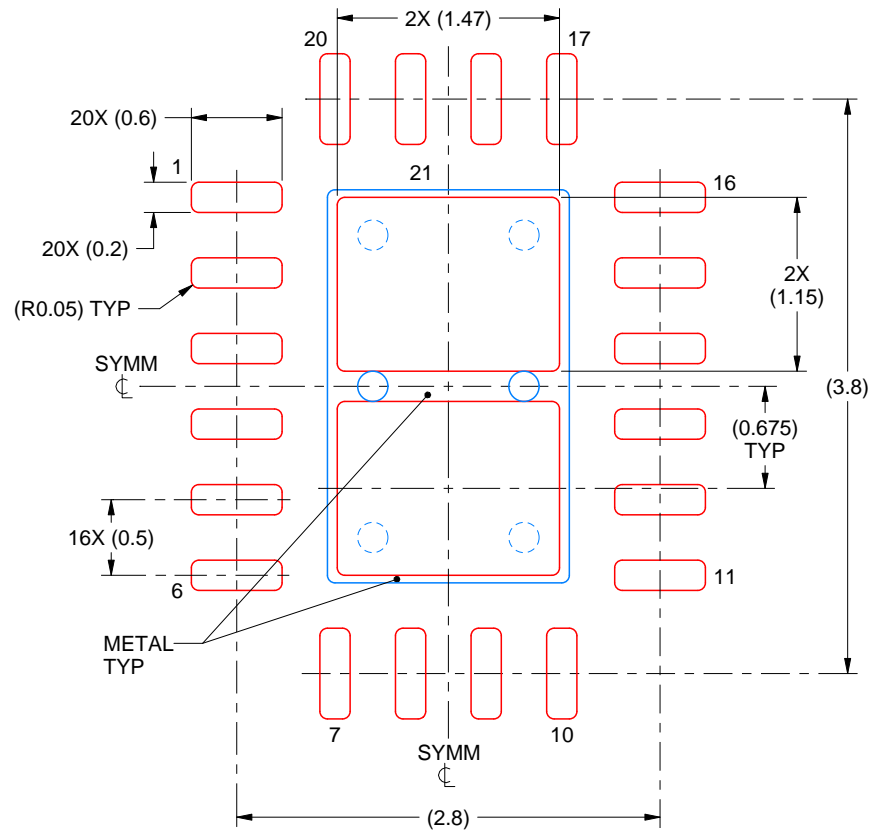

SOLDER PASTE EXAMPLE  
BASED ON 0.1 mm THICK STENCIL

EXPOSED PAD X  
81% PRINTED SOLDER COVERAGE BY AREA UNDER PACKAGE  
SCALE:20X

4219150/B 03/2017

NOTES: (continued)

6. Laser cutting apertures with trapezoidal walls and rounded corners may offer better paste release. IPC-7525 may have alternate design recommendations.

## IMPORTANT NOTICE AND DISCLAIMER

TI PROVIDES TECHNICAL AND RELIABILITY DATA (INCLUDING DATASHEETS), DESIGN RESOURCES (INCLUDING REFERENCE DESIGNS), APPLICATION OR OTHER DESIGN ADVICE, WEB TOOLS, SAFETY INFORMATION, AND OTHER RESOURCES "AS IS" AND WITH ALL FAULTS, AND DISCLAIMS ALL WARRANTIES, EXPRESS AND IMPLIED, INCLUDING WITHOUT LIMITATION ANY IMPLIED WARRANTIES OF MERCHANTABILITY, FITNESS FOR A PARTICULAR PURPOSE OR NON-INFRINGEMENT OF THIRD PARTY INTELLECTUAL PROPERTY RIGHTS.

These resources are intended for skilled developers designing with TI products. You are solely responsible for (1) selecting the appropriate TI products for your application, (2) designing, validating and testing your application, and (3) ensuring your application meets applicable standards, and any other safety, security, or other requirements. These resources are subject to change without notice. TI grants you permission to use these resources only for development of an application that uses the TI products described in the resource. Other reproduction and display of these resources is prohibited. No license is granted to any other TI intellectual property right or to any third party intellectual property right. TI disclaims responsibility for, and you will fully indemnify TI and its representatives against, any claims, damages, costs, losses, and liabilities arising out of your use of these resources.

TI's products are provided subject to TI's Terms of Sale ([www.ti.com/legal/termsofsale.html](http://www.ti.com/legal/termsofsale.html)) or other applicable terms available either on [ti.com](http://ti.com) or provided in conjunction with such TI products. TI's provision of these resources does not expand or otherwise alter TI's applicable warranties or warranty disclaimers for TI products.

Mailing Address: Texas Instruments, Post Office Box 655303, Dallas, Texas 75265  
Copyright © 2019, Texas Instruments Incorporated