

Bidirectional Ultra Low Capacitance TVS Array

DESCRIPTION

The GBLC03C Series are ultra low capacitance transient voltage suppressor arrays, designed to protect applications such as portable electronics and SMART phones. This series is available in both unidirectional and bidirectional configurations and is rated at 350 Watts for an 8/20 μ s waveshape.

The GBLC03C and Series meets IEC 61000-4-2 (ESD) and IEC 61000-4-4 (EFT) requirements. At higher operating frequencies or faster edge rates, insertion loss and signal integrity are a major concern. This series offers a ultra low capacitance and low leakage current in a miniature SOD-323 package.

APPLICATIONS

- ◇ Cell Phone Handsets and Accessories
- ◇ Microprocessor based equipment
- ◇ Personal Digital Assistants (PDA's)
- ◇ Notebooks, Desktops, and Servers
- ◇ Portable Instrumentation
- ◇ Peripherals
- ◇ USB Interface

PIN CONFIGURATION

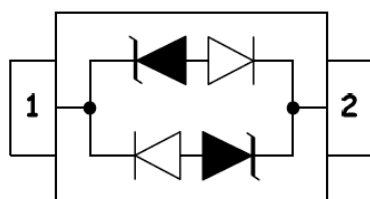

FEATURES

- ◇ IEC61000-4-2 (ESD) \pm 15kV (air), \pm 8kV (contact)
- ◇ IEC61000-4-4 (EFT) 40A (5/50 η s)
- ◇ IEC61000-4-5 (Lightning) 12A (8/20 μ s)
- ◇ Protects one I/O line (bidirectional)
- ◇ Low clamping voltage
- ◇ Working voltages : 3V, 5V, 8V, 12V, 15V, 24V
- ◇ Low leakage current
- ◇ Response Time is < 1 ns

MACHANICAL DATA

- ◇ SOD-323 package
- ◇ Flammability Rating: UL 94V-0
- ◇ Packaging: Tape and Reel
- ◇ High temperature soldering guaranteed:260 $^{\circ}$ C/10s
- ◇ Reel size: 7 inch
- ◇ Quantity per reel: 3,000pcs

PACKAGE OUTLINE



ABSOLUTE MAXIMUM RATING			
Symbol	Parameter	Value	Units
V_{ESD}	ESD per IEC 61000-4-2 (Air)	± 15	kV
	ESD per IEC 61000-4-2 (Contact)	± 8	
P_{PP}	Peak Pulse Power (8/20 μ s)	300	W
T_{OPT}	Operating Temperature	-55/+150	$^{\circ}$ C
T_{STG}	Storage Temperature	-55/+150	$^{\circ}$ C
T_L	Lead Soldering Temperature	260	$^{\circ}$ C

ELECTRICAL CHARACTERISTICS (T _{amb} =25 $^{\circ}$ C)									
PART NUMBER	DEVICE MARKING	V_{RWM}	V_B	I_T	$V_C@1$	V_C		I_R	C_T
		(V) (max.)	(V) (min.)	(mA)	(V) (max.)	(V) (max.)	(@A)	(μ A) (max.)	(pF) (typ.)
GBLC03C	3B	3.0	4.0	1	7.0	13.9	8	2	0.8
GBLC05C	AC	5.0	6.0	1	9.8	18.3	8	1	0.8
GBLC08C	BC	8.0	8.5	1	13.4	18.5	8	1	0.8
GBLC12C	DC	12.0	13.3	1	19.0	28.6	6	1	0.8
GBLC15C	EC	15.0	16.7	1	24.0	31.8	5	1	0.8
GBLC24C	HC	24.0	26.7	1	43.0	56.0	3	1	0.8

ELECTRICAL CHARACTERISTICS CURVE

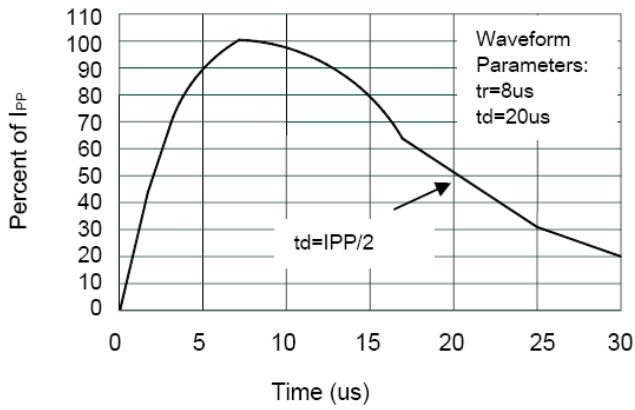

Pulse Waveform

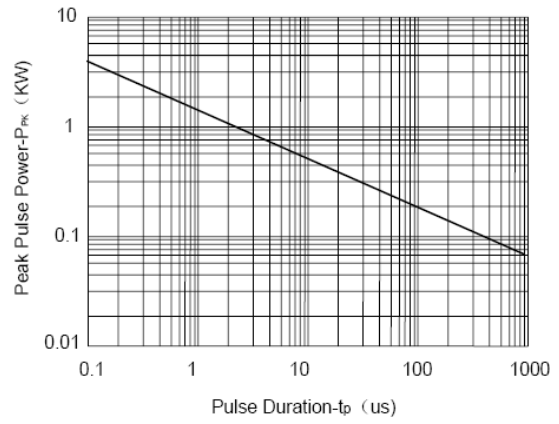

Non-Repetitive Peak Pulse Power vs. Pulse Time

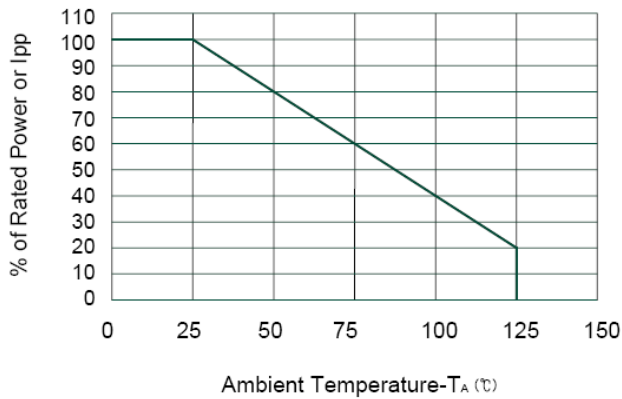

Power Derating Curve

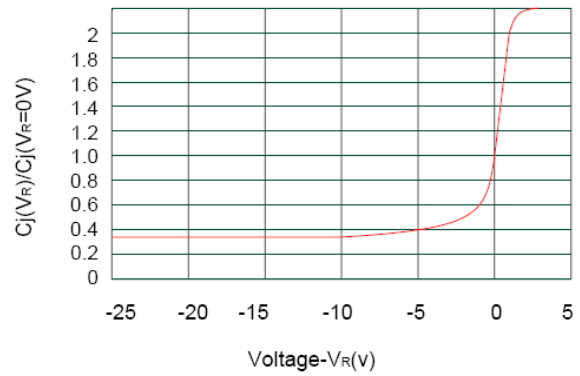

Junction Capacitance vs. Reverse Voltage

SOD-323 PACKAGE OUTLINE DIMENSIONS

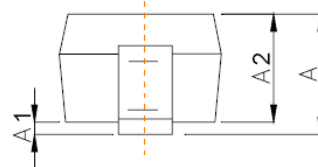
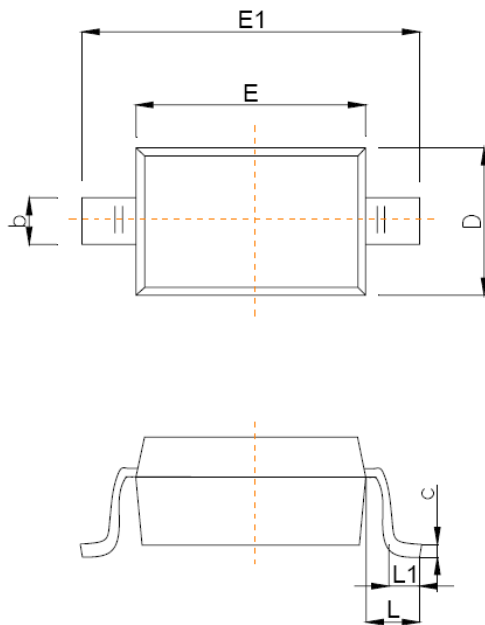

Symbol	Dimensions In Millimeters	
	Min	Max
A		1.00
A1	0.000	0.100
A2	0.800	0.900
b	0.250	0.350
c	0.080	0.150
D	1.200	1.400
E	1.600	1.800
E1	2.500	2.700
e	1.800	2.040
L	0.475 REF	
L1	0.250	0.400
θ	0°	8°

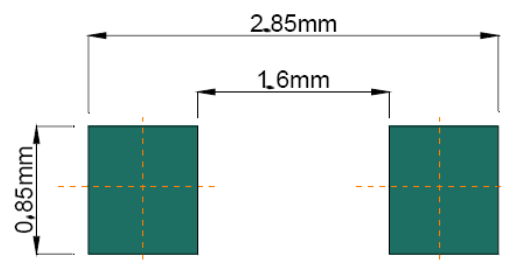

Recommended Pad outline