

Trench gate field-stop, 650 V, 30 A, high-speed HB2 series IGBT in a D²PAK package

 D²PAK

NG1E3C2T

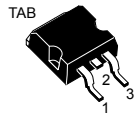
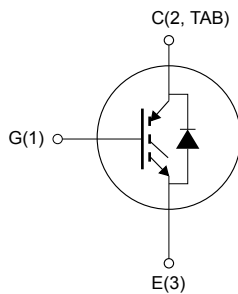

Features

- Maximum junction temperature : $T_J = 175\text{ °C}$
- Low $V_{CE(sat)} = 1.65\text{ V (typ.) @ } I_C = 30\text{ A}$
- Very fast and soft recovery co-packaged diode
- Minimized tail current
- Tight parameter distribution
- Low thermal resistance
- Positive $V_{CE(sat)}$ temperature coefficient

Applications

- Welding
- Power factor correction
- UPS
- Solar inverters
- Chargers

Description

The newest IGBT 650 V HB2 series represents an evolution of the advanced proprietary trench gate field-stop structure. The performance of the HB2 series is optimized in terms of conduction, thanks to a better $V_{CE(sat)}$ behavior at low current values, as well as in terms of reduced switching energy. A very fast soft recovery diode is co-packaged in antiparallel with the IGBT. The result is a product specifically designed to maximize efficiency for a wide range of fast applications.

Product status link

[STGB30H65DFB2](#)

Product summary

Order code	STGB30H65DFB2
Marking	G30H65DFB2
Package	D ² PAK
Packing	Tape and reel

1 Electrical ratings

Table 1. Absolute maximum ratings

Symbol	Parameter	Value	Unit
V_{CES}	Collector-emitter voltage ($V_{GE} = 0$ V)	650	V
I_C	Continuous collector current at $T_C = 25$ °C	50	A
	Continuous collector current at $T_C = 100$ °C	30	A
$I_{CP}^{(1)(2)}$	Pulsed collector current	90	A
V_{GE}	Gate-emitter voltage	± 20	V
	Transient gate-emitter voltage ($t_p \leq 10$ μ s)	± 30	
I_F	Continuous forward current at $T_C = 25$ °C	41	A
	Continuous forward current at $T_C = 100$ °C	24	
$I_{FP}^{(1)(2)}$	Pulsed forward current	120	A
P_{TOT}	Total power dissipation at $T_C = 25$ °C	167	W
T_{STG}	Storage temperature range	-55 to 150	°C
T_J	Operating junction temperature range	-55 to 175	°C

1. Pulse width is limited by maximum junction temperature.
2. Defined by design, not subject to production test.

Table 2. Thermal data

Symbol	Parameter	Value	Unit
R_{thJC}	Thermal resistance junction-case IGBT	0.9	°C/W
	Thermal resistance junction-case diode	1.47	
R_{thJA}	Thermal resistance junction-ambient	62.5	

2 Electrical characteristics

$T_C = 25\text{ °C}$ unless otherwise specified

Table 3. Static characteristics

Symbol	Parameter	Test conditions	Min.	Typ.	Max.	Unit
$V_{(BR)CES}$	Collector-emitter breakdown voltage	$V_{GE} = 0\text{ V}$, $I_C = 1\text{ mA}$	650			V
$V_{CE(sat)}$	Collector-emitter saturation voltage	$V_{GE} = 15\text{ V}$, $I_C = 30\text{ A}$		1.65	2.1	V
		$V_{GE} = 15\text{ V}$, $I_C = 30\text{ A}$, $T_J = 125\text{ °C}$		1.85		
		$V_{GE} = 15\text{ V}$, $I_C = 30\text{ A}$, $T_J = 175\text{ °C}$		2.0		
V_F	Forward on-voltage	$I_F = 30\text{ A}$		1.80	2.8	V
		$I_F = 30\text{ A}$, $T_J = 125\text{ °C}$		1.60		
		$I_F = 30\text{ A}$, $T_J = 175\text{ °C}$		1.50		
$V_{GE(th)}$	Gate threshold voltage	$V_{CE} = V_{GE}$, $I_C = 1\text{ mA}$	5	6	7	V
I_{CES}	Collector cut-off current	$V_{GE} = 0\text{ V}$, $V_{CE} = 650\text{ V}$			25	μA
I_{GES}	Gate-emitter leakage current	$V_{CE} = 0\text{ V}$, $V_{GE} = \pm 20\text{ V}$			± 250	nA

Table 4. Dynamic characteristics

Symbol	Parameter	Test conditions	Min.	Typ.	Max.	Unit
C_{ies}	Input capacitance	$V_{CE} = 25\text{ V}$, $f = 1\text{ MHz}$, $V_{GE} = 0\text{ V}$	-	1570	-	pF
C_{oes}	Output capacitance		-	98	-	
C_{res}	Reverse transfer capacitance		-	40	-	
Q_g	Total gate charge	$V_{CC} = 520\text{ V}$, $I_C = 30\text{ A}$, $V_{GE} = 0\text{ to }15\text{ V}$ (see Figure 28. Gate charge test circuit)	-	90	-	nC
Q_{ge}	Gate-emitter charge		-	15.3	-	
Q_{gc}	Gate-collector charge		-	41.5	-	

Table 5. Switching characteristics (inductive load)

Symbol	Parameter	Test conditions	Min.	Typ.	Max.	Unit
$t_{d(on)}$	Turn-on delay time	$V_{CC} = 400\text{ V}$, $I_C = 30\text{ A}$, $V_{GE} = 15\text{ V}$, $R_G = 6.8\ \Omega$ (see Figure 27. Test circuit for inductive load switching)	-	18.4	-	ns
t_r	Current rise time		-	5.8	-	ns
$E_{on(1)}$	Turn-on switching energy		-	270	-	μJ
$t_{d(off)}$	Turn-off delay time		-	71	-	ns
t_f	Current fall time		-	41	-	ns
$E_{off(2)}$	Turn-off switching energy		-	310	-	μJ
$t_{d(on)}$	Turn-on delay time	$V_{CC} = 400\text{ V}$, $I_C = 30\text{ A}$, $V_{GE} = 15\text{ V}$, $R_G = 6.8\ \Omega$, $T_J = 175\text{ }^\circ\text{C}$ (see Figure 27. Test circuit for inductive load switching)	-	19	-	ns
t_r	Current rise time		-	8.5	-	ns
$E_{on(1)}$	Turn-on switching energy		-	477	-	μJ
$t_{d(off)}$	Turn-off delay time		-	79	-	ns
t_f	Current fall time		-	105	-	ns
$E_{off(2)}$	Turn-off switching energy		-	643	-	μJ

1. Including the reverse recovery of the diode.
2. Including the tail of the collector current.

Table 6. Diode switching characteristics (inductive load)

Symbol	Parameter	Test conditions	Min.	Typ.	Max.	Unit
t_{rr}	Reverse recovery time	$I_F = 30\text{ A}$, $V_R = 400\text{ V}$, $V_{GE} = 15\text{ V}$, $di/dt = 1000\text{ A}/\mu\text{s}$ (see Figure 30. Diode reverse recovery waveform)	-	115	-	ns
Q_{rr}	Reverse recovery charge		-	600	-	nC
I_{rrm}	Reverse recovery current		-	15	-	A
dI_{rr}/dt	Peak rate of fall of reverse recovery current during t_b		-	700	-	$\text{A}/\mu\text{s}$
E_{rr}	Reverse recovery energy		-	145	-	μJ
t_{rr}	Reverse recovery time	$I_F = 30\text{ A}$, $V_R = 400\text{ V}$, $V_{GE} = 15\text{ V}$, $di/dt = 1000\text{ A}/\mu\text{s}$, $T_J = 175\text{ }^\circ\text{C}$ (see Figure 30. Diode reverse recovery waveform)	-	221	-	ns
Q_{rr}	Reverse recovery charge		-	2550	-	nC
I_{rrm}	Reverse recovery current		-	26	-	A
dI_{rr}/dt	Peak rate of fall of reverse recovery current during t_b		-	192	-	$\text{A}/\mu\text{s}$
E_{rr}	Reverse recovery energy		-	720	-	μJ

2.1 Electrical characteristics (curves)

Figure 1. Power dissipation vs case temperature

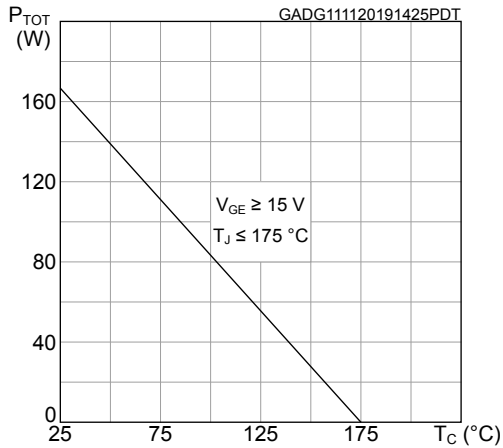

Figure 2. Collector current vs case temperature

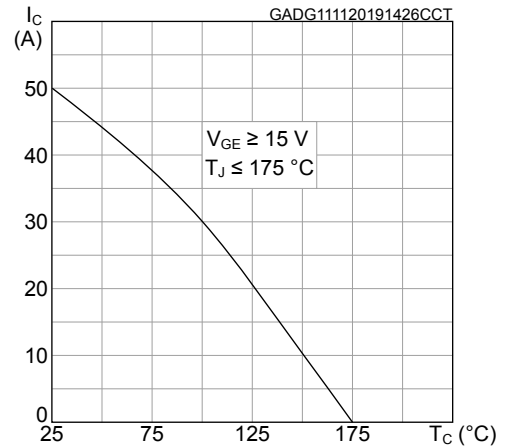

Figure 3. Output characteristics ($T_J = 25\text{ °C}$)

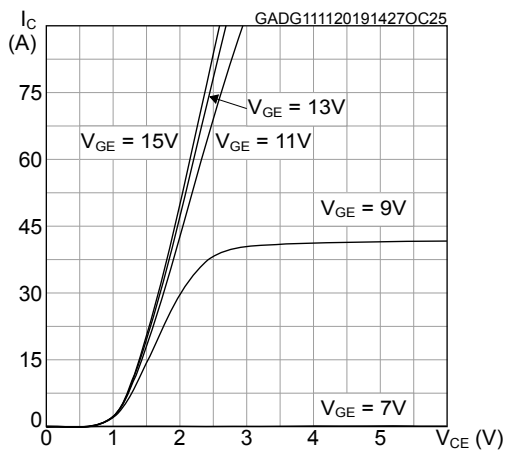

Figure 4. Output characteristics ($T_J = 175\text{ °C}$)

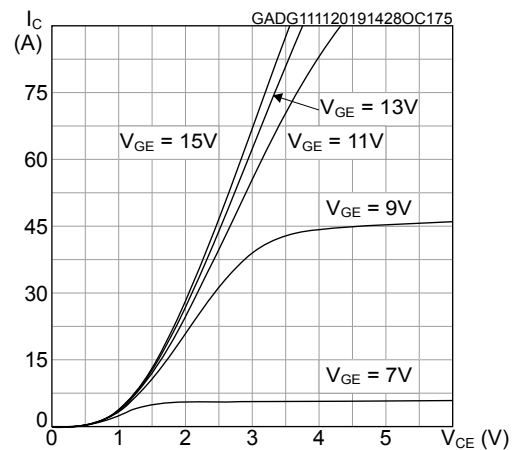

Figure 5. $V_{CE(sat)}$ vs junction temperature

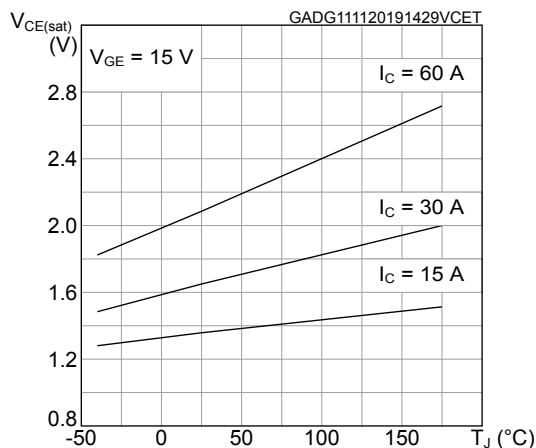

Figure 6. $V_{CE(sat)}$ vs collector current

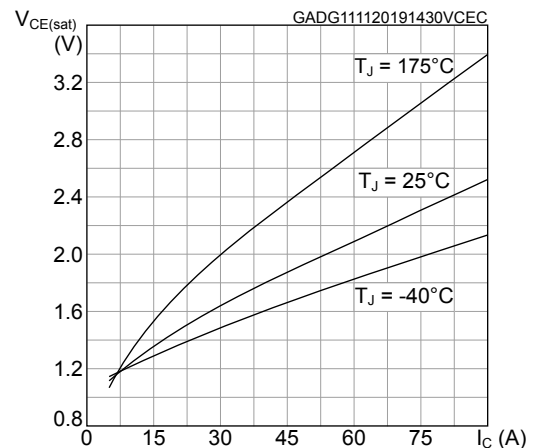

Figure 7. Forward bias safe operating area

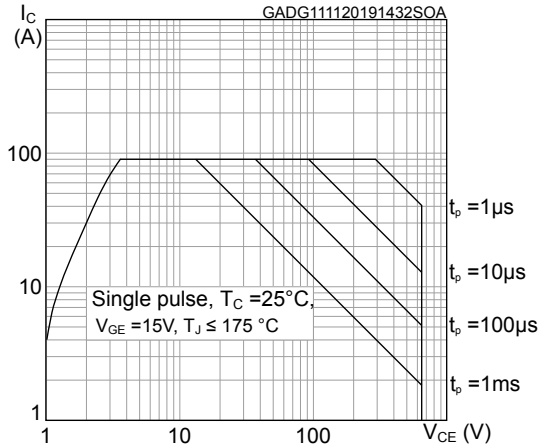

Figure 8. Collector current vs switching frequency

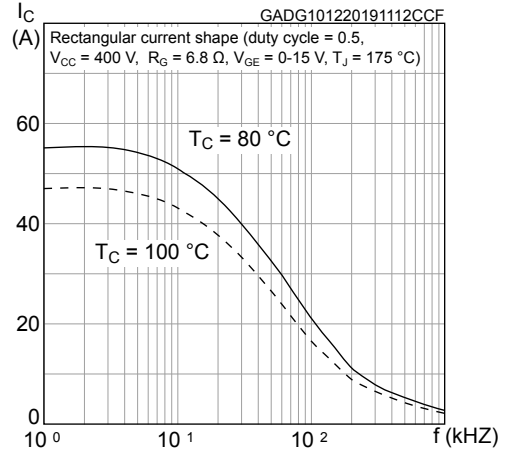

Figure 9. Transfer characteristics

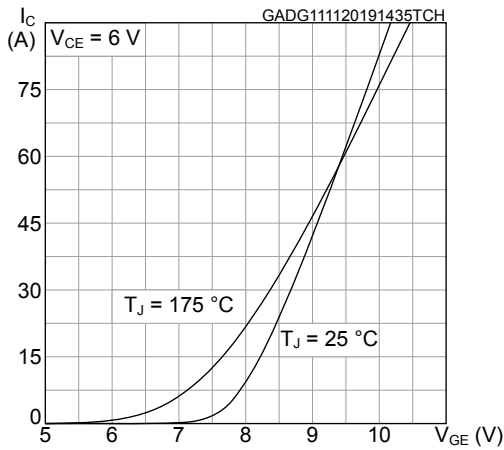

Figure 10. Diode V_F vs forward current

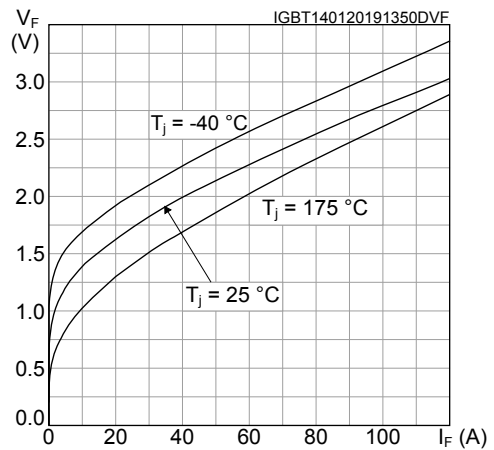

Figure 11. Normalized V_GE(th) vs junction temperature

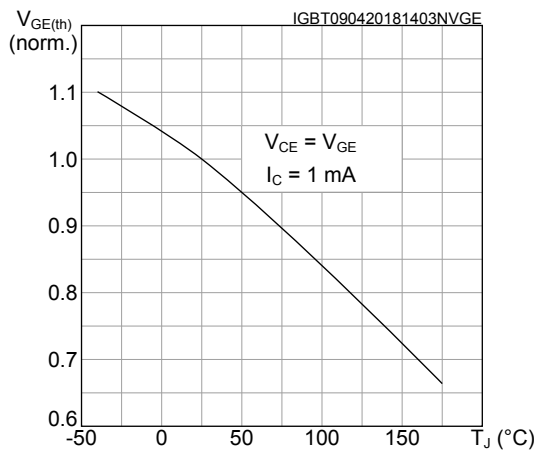

Figure 12. Normalized V_(BR)CES vs junction temperature

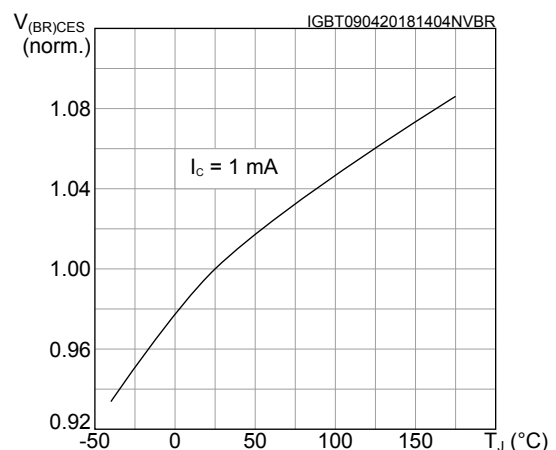

Figure 13. Capacitance variations

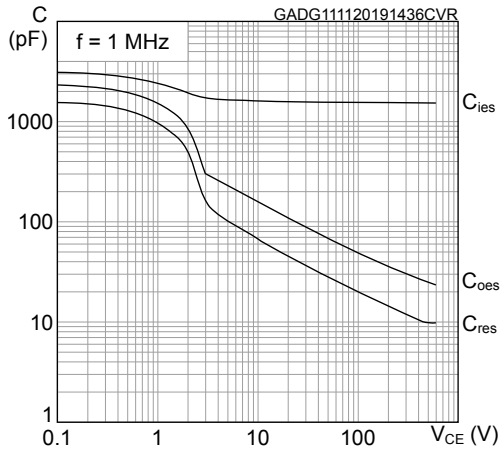

Figure 14. Gate charge vs gate-emitter voltage

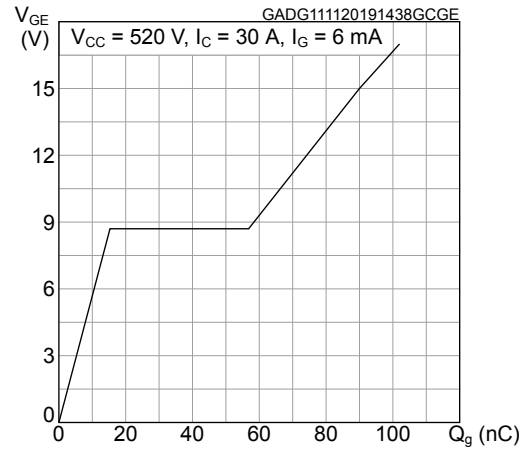

Figure 15. Switching energy vs collector current

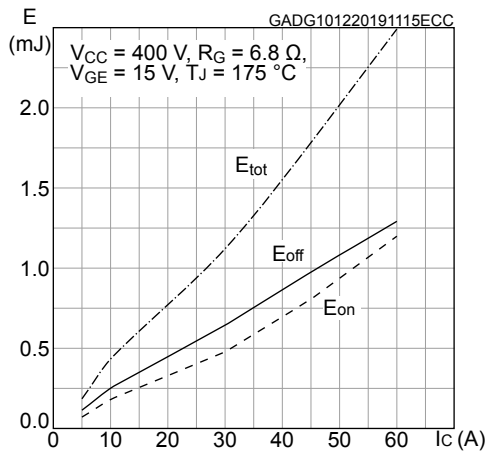

Figure 16. Switching energy vs temperature

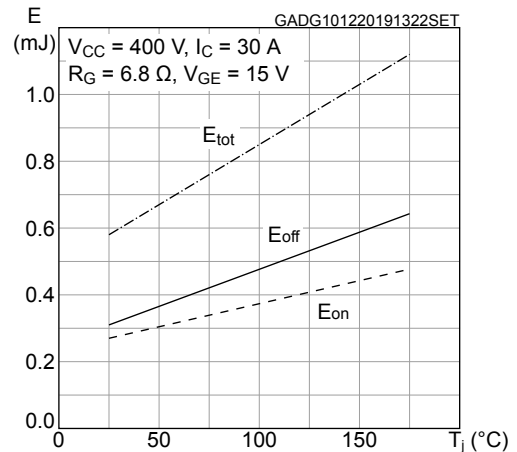

Figure 17. Switching energy vs collector emitter voltage

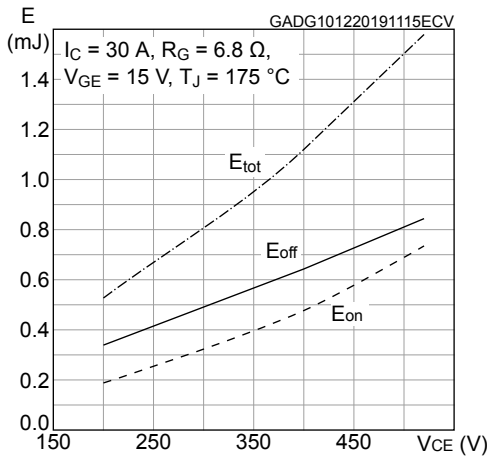

Figure 18. Switching energy vs gate resistance

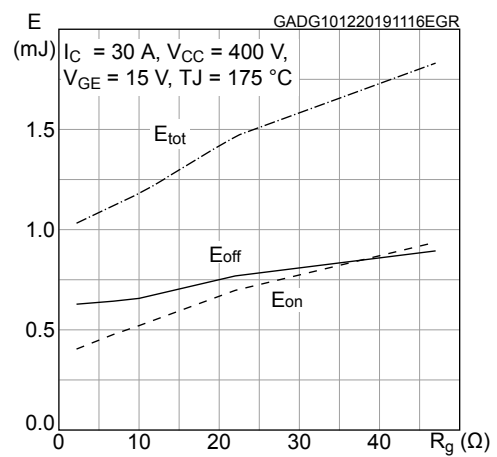

Figure 19. Switching times vs collector current

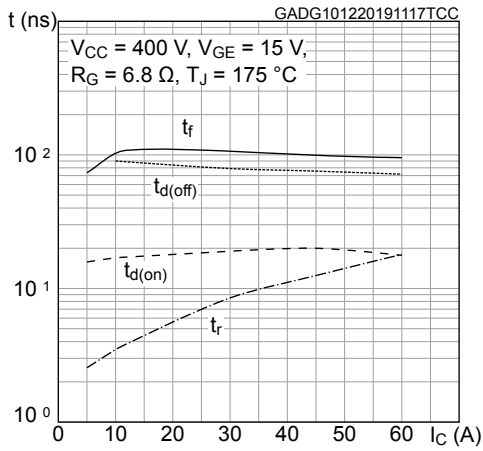

Figure 20. Switching times vs gate resistance

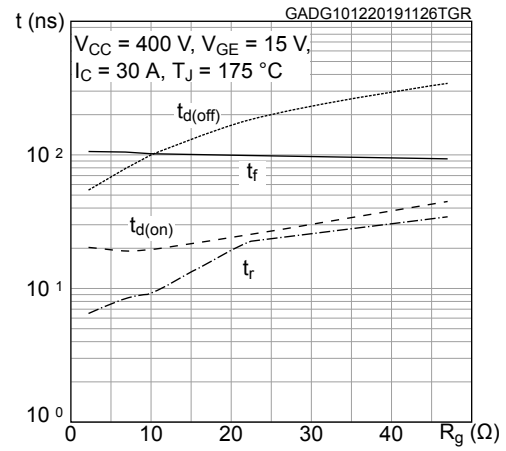

Figure 21. Reverse recovery current vs diode current slope

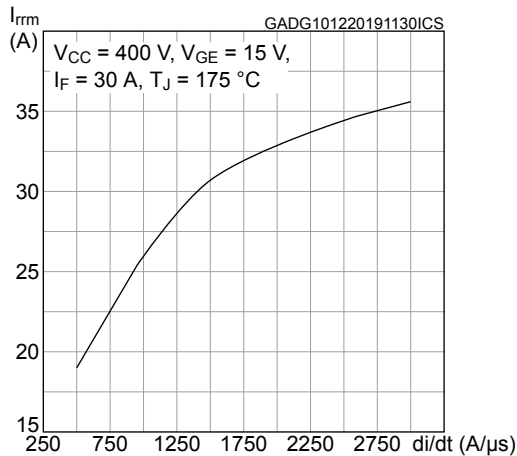

Figure 22. Reverse recovery time vs diode current slope

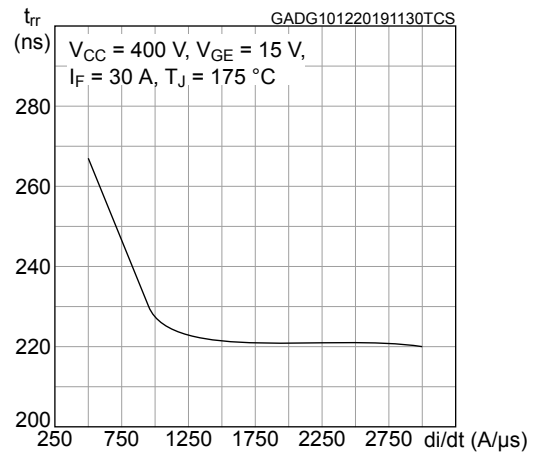

Figure 23. Reverse recovery charge vs diode current slope

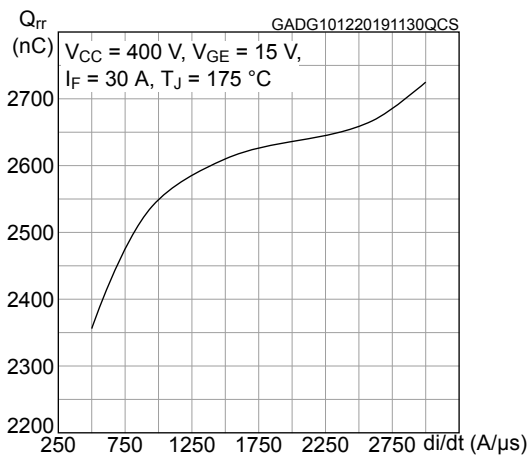

Figure 24. Reverse recovery energy vs diode current slope

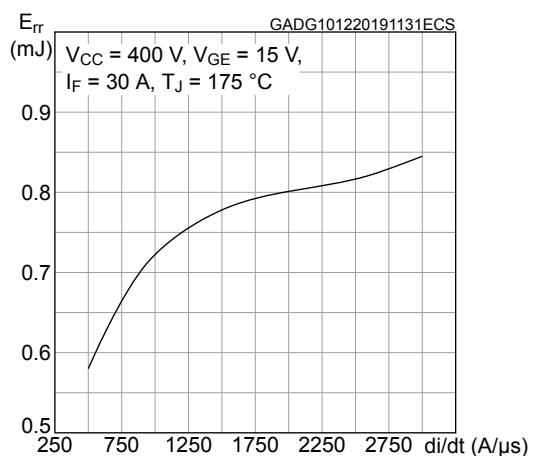

Figure 25. Thermal impedance for IGBT

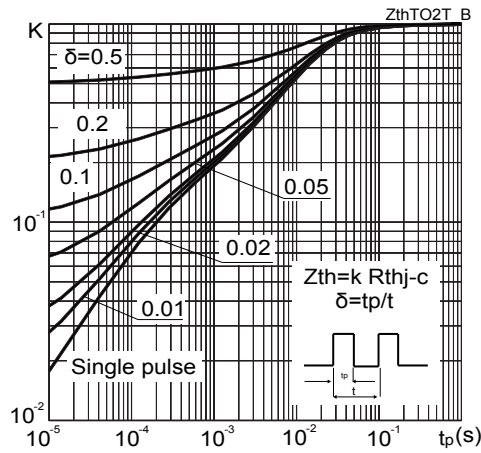
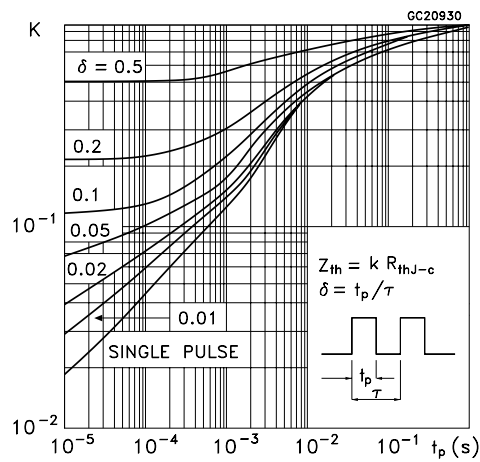
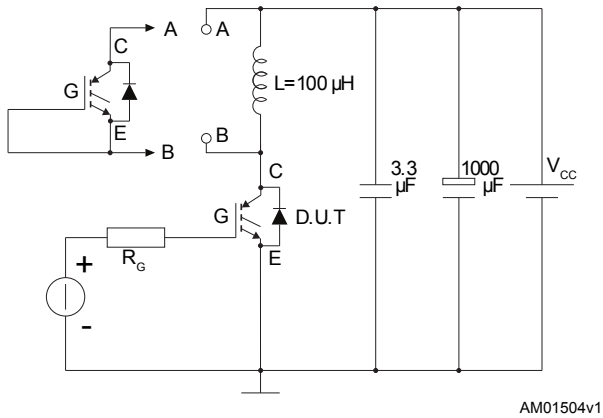
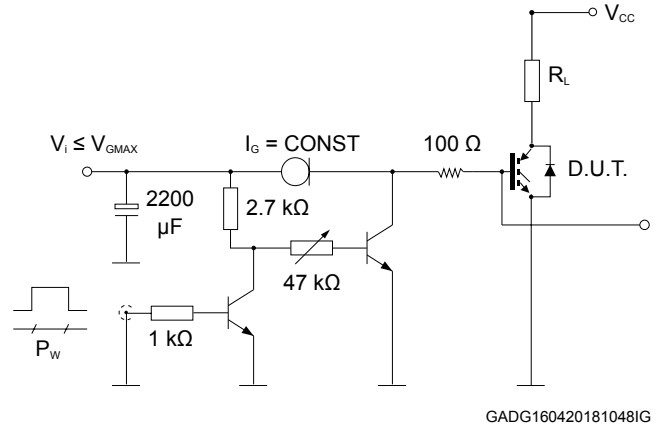
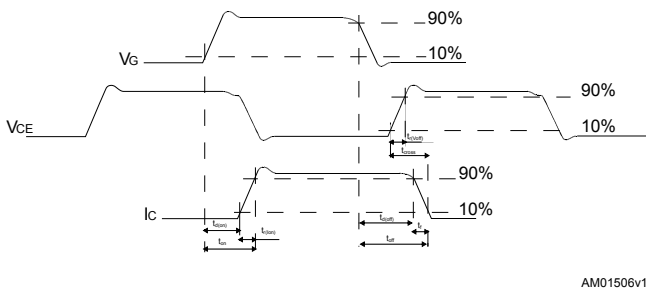
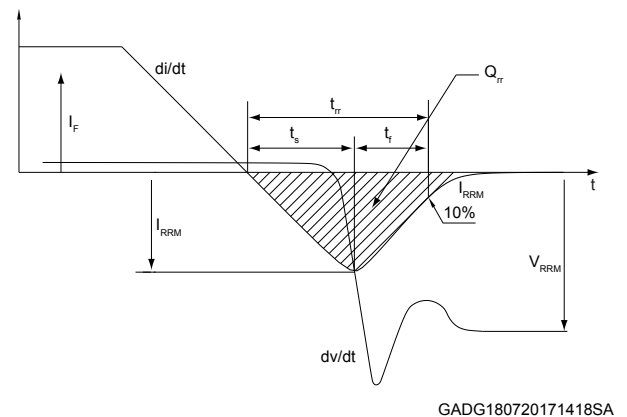

Figure 26. Thermal impedance for diode



3 Test circuits

Figure 27. Test circuit for inductive load switching

Figure 28. Gate charge test circuit

Figure 29. Switching waveform

Figure 30. Diode reverse recovery waveform

4 Package information

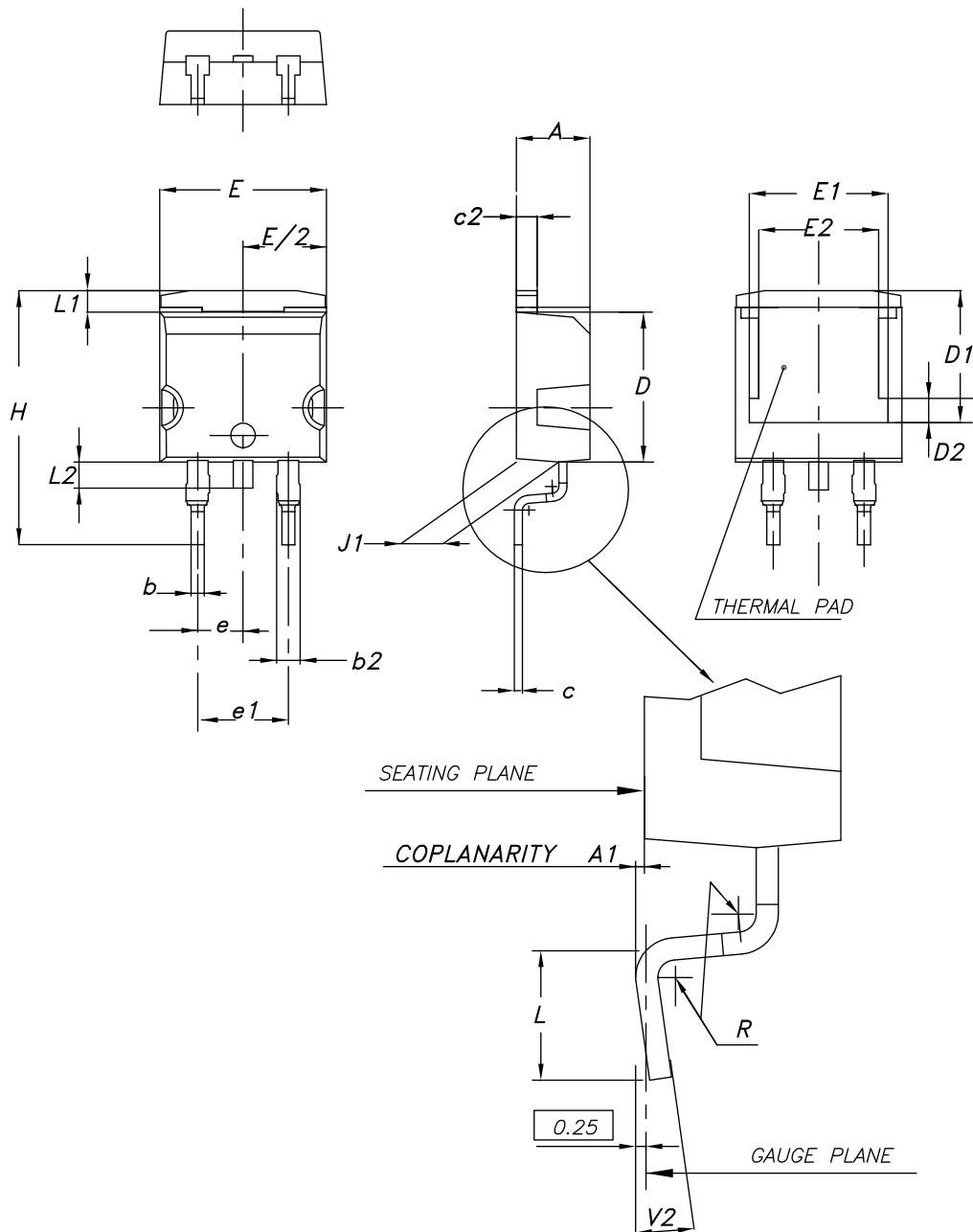
In order to meet environmental requirements, ST offers these devices in different grades of **ECOPACK** packages, depending on their level of environmental compliance. ECOPACK specifications, grade definitions and product status are available at: www.st.com. ECOPACK is an ST trademark.

4.1 D²PAK (TO-263) type A2 package information

Figure 31. D²PAK (TO-263) type A2 package outline



0079457_A2_26

Table 7. D²PAK (TO-263) type A2 package mechanical data

Dim.	mm		
	Min.	Typ.	Max.
A	4.40		4.60
A1	0.03		0.23
b	0.70		0.93
b2	1.14		1.70
c	0.45		0.60
c2	1.23		1.36
D	8.95		9.35
D1	7.50	7.75	8.00
D2	1.10	1.30	1.50
E	10.00		10.40
E1	8.70	8.90	9.10
E2	7.30	7.50	7.70
e		2.54	
e1	4.88		5.28
H	15.00		15.85
J1	2.49		2.69
L	2.29		2.79
L1	1.27		1.40
L2	1.30		1.75
R		0.40	
V2	0°		8°

Figure 32. D²PAK (TO-263) recommended footprint (dimensions are in mm)

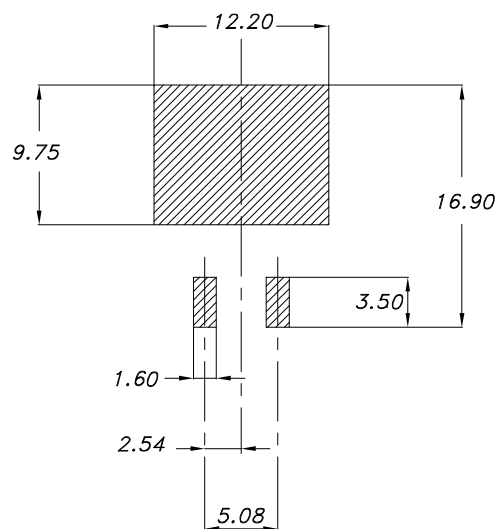

Footprint_26

4.2 D²PAK packing information

Figure 33. D²PAK tape outline

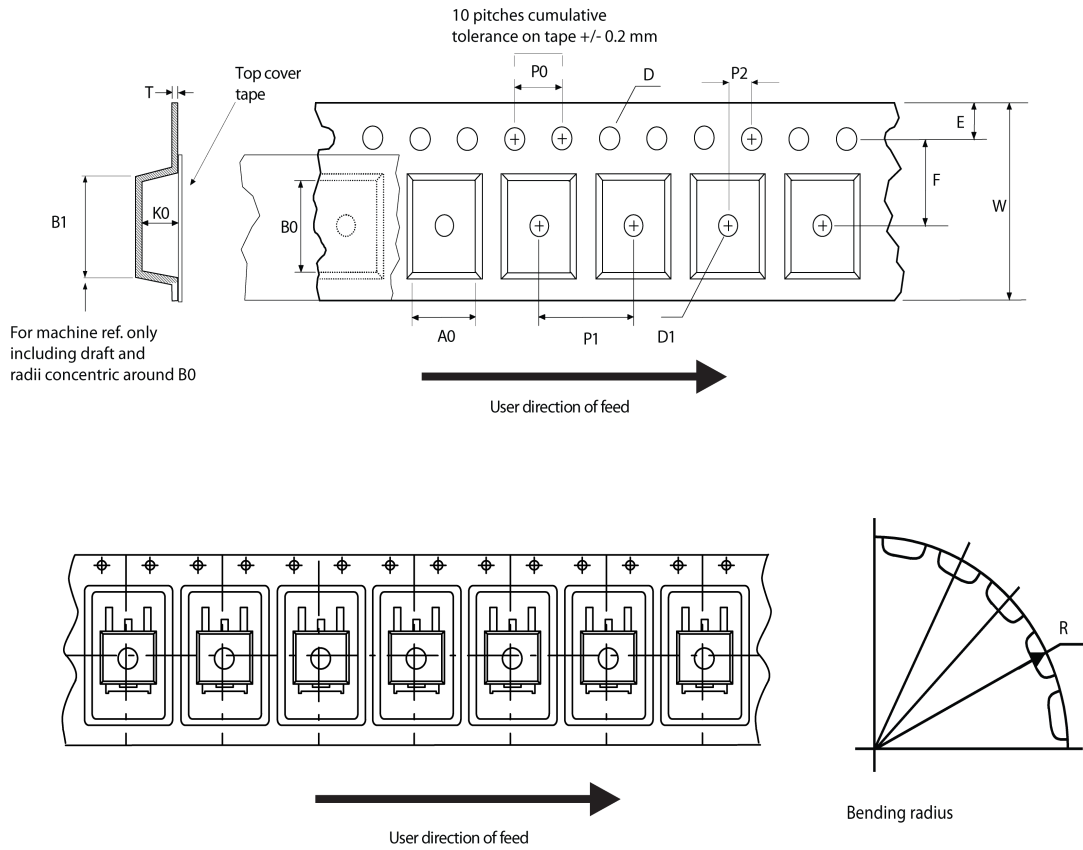

AM08852v1

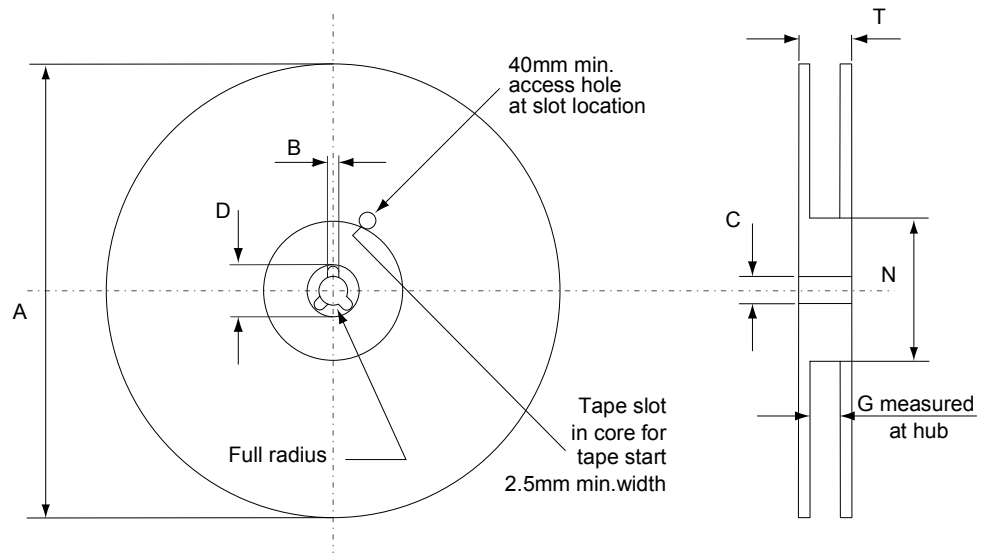
Figure 34. D²PAK reel outline

AM06038v1

Table 8. D²PAK tape and reel mechanical data

Tape			Reel		
Dim.	mm		Dim.	mm	
	Min.	Max.		Min.	Max.
A0	10.5	10.7	A		330
B0	15.7	15.9	B	1.5	
D	1.5	1.6	C	12.8	13.2
D1	1.59	1.61	D	20.2	
E	1.65	1.85	G	24.4	26.4
F	11.4	11.6	N	100	
K0	4.8	5.0	T		30.4
P0	3.9	4.1			
P1	11.9	12.1	Base quantity		1000
P2	1.9	2.1	Bulk quantity		1000
R	50				
T	0.25	0.35			
W	23.7	24.3			

Revision history

Table 9. Document revision history

Date	Version	Changes
17-Feb-2020	1	First release.

Contents

1	Electrical ratings	2
2	Electrical characteristics	3
2.1	Electrical characteristics (curves)	4
3	Test circuits	10
4	Package information	11
4.1	D ² PAK (TO-263) type A2 package information	11
4.2	D ² PAK packing information	12
	Revision history	15

IMPORTANT NOTICE – PLEASE READ CAREFULLY

STMicroelectronics NV and its subsidiaries (“ST”) reserve the right to make changes, corrections, enhancements, modifications, and improvements to ST products and/or to this document at any time without notice. Purchasers should obtain the latest relevant information on ST products before placing orders. ST products are sold pursuant to ST’s terms and conditions of sale in place at the time of order acknowledgement.

Purchasers are solely responsible for the choice, selection, and use of ST products and ST assumes no liability for application assistance or the design of Purchasers’ products.

No license, express or implied, to any intellectual property right is granted by ST herein.

Resale of ST products with provisions different from the information set forth herein shall void any warranty granted by ST for such product.

ST and the ST logo are trademarks of ST. For additional information about ST trademarks, please refer to www.st.com/trademarks. All other product or service names are the property of their respective owners.

Information in this document supersedes and replaces information previously supplied in any prior versions of this document.

© 2020 STMicroelectronics – All rights reserved