

# XS5/XS2 Assembly Tooling and Accessories

## Tooling

### Crimp Tool XY2F-0002

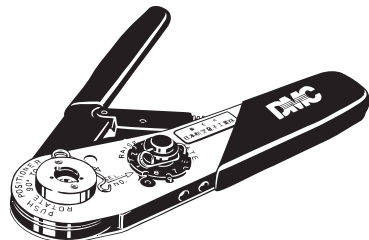

Use the Crimp Tool to crimp a cable core to the XS5U or XS2U Crimping Pin used with the XS□C or XS□G Crimping Connector.

- The XY2F-0002 Crimp Tool is DMC's AFM8 (M22520/2-01).
- Mount the XY2F-0003 Locator (sold separately) to the locator guide of the Crimp Tool with a screw provided with the XY2F-0003 Locator.

### Locator XY2F-0003

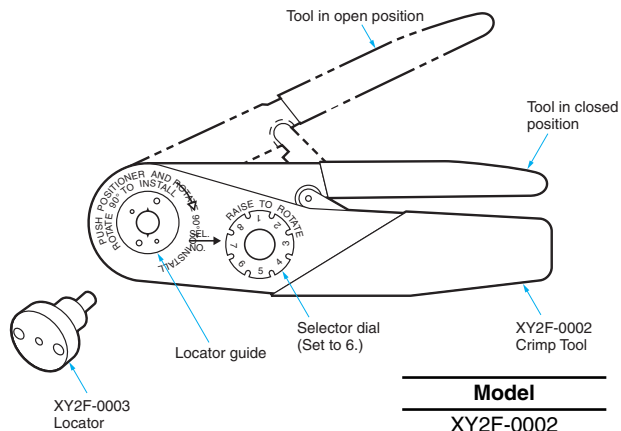

Model
XY2F-0002
XY2F-0003

### Pin-block Extraction Tool XY2F-0001

Use this tool to extract a Pin Block from the covers in order to make wiring changes or corrections after the cover has been mounted to the pin block for Connector Assemblies (XS□C/XS□G, soldering/crimping).

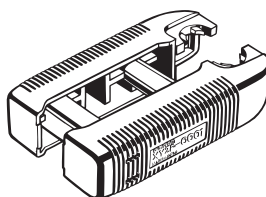

Model
XY2F-0001

## Extraction Procedure

### 1. Disconnecting Components

- Disconnect all components on the cap side from the cover.

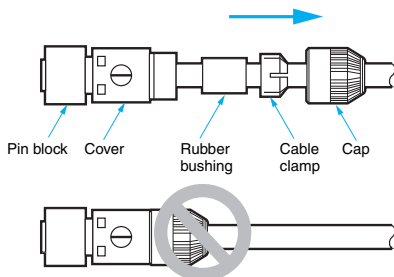

- Make sure that the pin block is outside the Tool.

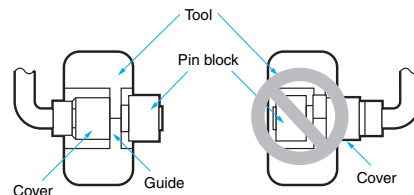

- Press the Tool so that the guides of the Tool are in close contact. Then pull the pin block straight.

### 2. Extracting Pin Block

- Insert the claws of the Tool into the four holes of the cover.

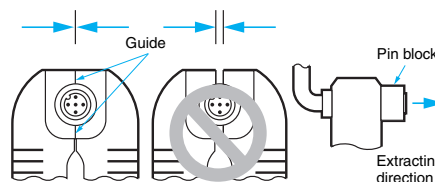
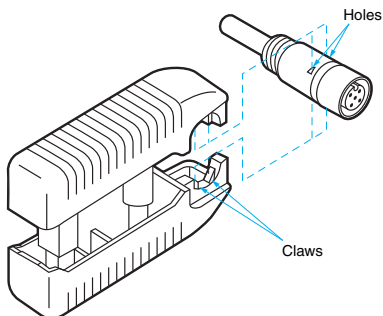

### Precaution for Safe Use

- The pin block must not be extracted from the same Connector more than 3 times, otherwise the proper degree of protection of the pin block or Connector will not be maintained.

# Assembly Procedure for XS5C/XS5G (IDC models) Connector Assemblies

## 1. Preparations (Make sure they are all at hand.)

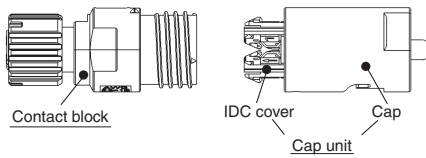

## 2. Dressing the cable end

- Peel covering of a cable.

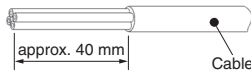

External diameter of applicable cable	Conductor cross section
3 to 8 mm	0.14 to 0.75mm <sup>2</sup> / AWG26 to 18

## 3. Choose the waterproof bushing

- Choose the waterproof bushing type according to the cable size.

### <External diameter of cable: In case of 3 to 5 mm>

Use the cap unit in the delivery state.

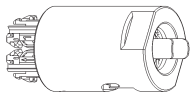

### <External diameter of cable: In case of 5 to 8 mm>

When using, pick tab both sides of the waterproof bushing with a tab and pull it out in the direction of an arrow.

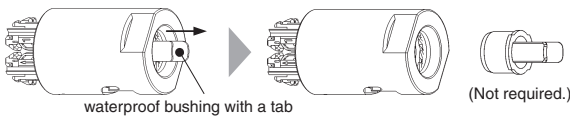

**Note:** When it isn't necessary to pull out bushing, do not pull a tab or pull out bushing carelessly. Do not insert the pulled-out bushing again.

## 4. Cable insertion

- Insert a cable in the cap unit.

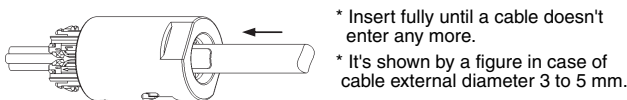

- \* Insert fully until a cable doesn't enter any more.
- \* It's shown by a figure in case of cable external diameter 3 to 5 mm.

## 5. Wiring

- Confirm the terminal number indication<sup>\*1</sup> of a IDC (Insulation Displacement Contact) cover, insert a core wire in each wire guide according to the terminal number and push in to the lowermost part of a core wire storage part.

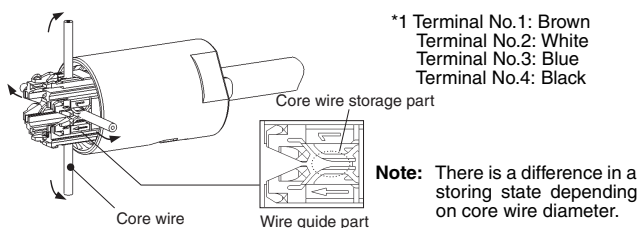

- \*1 Terminal No.1: Brown
- Terminal No.2: White
- Terminal No.3: Blue
- Terminal No.4: Black

**Note:** There is a difference in a storing state depending on core wire diameter.

## 6. Processing the core wire end

- Cut the end part of each core wire with nippers. Cutting the core wire end in the range of cut-area of figure.

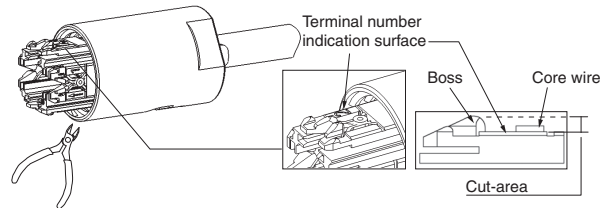

**Note:** Please be careful not to cut the boss.

## 7. Assembling the Contact block

- Insert the cap unit core wire end processing has completed in a contact block.
- Use a  $\triangle$  mark of a housing and an arrow of a IDC cover, as a guideline of alignment. The location of the arrow is the side of the terminal No.1.

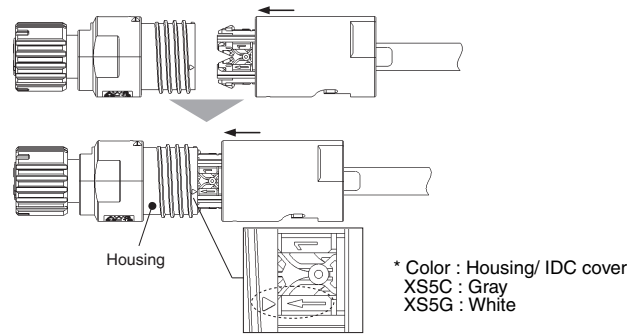

- \* Color : Housing/ IDC cover
- XS5C : Gray
- XS5G : White

**Note:** Confirm that the color of the housing and the IDC cover is same before insertion.

## 8. Tightening up the cap

- After inserting the cap unit and tightening a screw up lightly by hand, screw up the cap by a tool of a spanner or wrench (size 15 mm).<sup>\*2</sup>

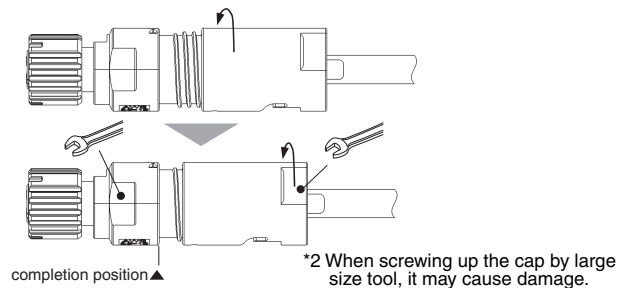

- When a gap between a mold cover of contact block and a cap disappeared assembly and wire connection has completed.

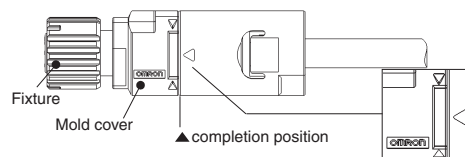

- Note:** 1. When the operation has completed,  $\triangle$  mark of cap comes into the square of the indicator formed into a mold cover ( $\triangleright \square \triangleleft$ ), so also use it as guideline to know to complete.
- 2. Avoid tightening a cap up beyond the completion position. It may cause damage.

## 9. Final checking

- When the connector has been assembled, make sure the line insulation is as specified.

## Repair work procedure

### Cap unit removal

- When releasing wire connection, remove the cap unit in the opposite procedure of assembly work. [ from (8) to (7) ]

- Note:**
1. The core wire remain connected to the IDC connection part rarely. In that case, remove core wire end part to the vertical direction by tweezers etc. Do not touch the IDC contact directly at that time.
  2. When IDC cover was left on the housing side, remove it by pulling a cable. In case IDC cover has been removed by holding strongly and pulling, it may cause damage.

### Cable removal

- When removing the cable from the cap unit, pull the cable to the opposite direction of assembly work procedure (4). When tip of the core wire end has been pushed lightly into the IDC cover by tweezers etc, cable removal becomes easy.

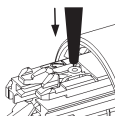

### Repair work

- When connecting the wire again, do assembly (repair work) according to assembling procedure from (1) to (8).

- Note:**
1. In case of repair, use a cable of the same diameter and a core wire of the same diameter. The number of times of repair wire connection is maximum 10 times.
  2. When doing a repair, work after enough removing the foreign substance and moisture adhering to a connector. Be careful so that the foreign substance and moisture do not enter the wire connection part. It may cause short-circuit etc.

# Assembly Procedure for XS□C/XS□G Connector Assemblies

## 1. Connector and Cable External Diameters

- Connectors for 6-, 4-, and 3-mm-diameter Cables (i.e., Cables that are 5 to 6, 4 to 5, and 3 to 4 mm in diameter respectively) are available. When assembling a Connector used with a cable, make sure that the external diameter of the Connector is suited to that of the cable.
- Connectors for 6-mm-diameter Cables use white cable clamps. Connectors for 4- and 3-mm-diameter Cables use black cable clamps. A watertight bushing for 6-mm-diameter Cable has no stripe, that for 4-mm-diameter Cable has a single stripe, and that for 3-mm-diameter Cable has two stripes.

**Note:** When connecting a commercially available cable to a connector assembly, use a cable with an outside diameter of 3 to 6 mm and core sizes of 0.18 to 0.75 mm<sup>2</sup> for crimping connectors and 0.5 mm<sup>2</sup> maximum for soldering connectors.

## 2. Component Insertion

### Crimping/Soldering Connectors

#### Straight Connectors

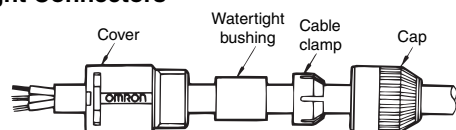

#### Angled Connectors

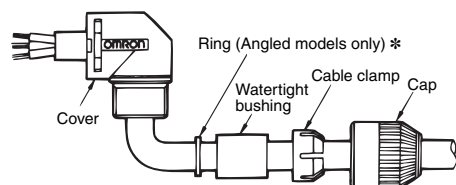

\* A ring is not required for Screw-on Connectors.

- As shown in the above illustration, connect the above components to the Cable with its end processed.

### Screw-on Connectors

#### Confirm that you have all of the required parts.

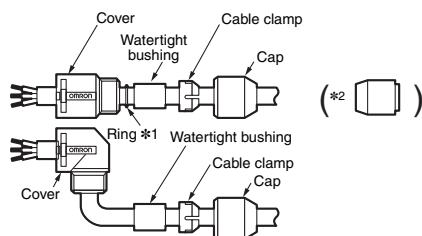

Insulation caps and insulation tubes are included with 5-pole Connectors (XS□C-D5S□ and XS□G-D5S□).

- \*1. Rings are not required with 7-mm and 8-mm cables.
- \*2. Insert the waterproof bushing for 7-mm and 8-mm cables in the direction shown in the diagram.

## 3. Wiring (Processing Cable Ends)

### Soldering Connectors

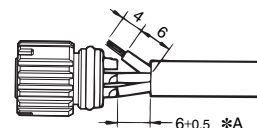

- Strip 10 mm of the Cable sheath and 4 mm of each core.
- Before soldering cores and solder cup pins together, solder-coat each of them.
- The following conditions are recommended for soldering each solder cup pin.  
Soldering iron: 30 to 60 W  
Soldering temperature: 280°C to 340°C  
Soldering period: 3 s max.
- The length marked \*A should be 6.5 mm max., otherwise the proper degree of protection of the connector will not be maintained.

### Crimping Connectors

#### Crimping

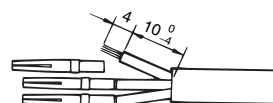

- Strip 14 mm of the Cable sheath and 4 mm of each core.
- Make sure that each core is not damaged and its end strands are not spread out.
- Mount the XY2F-0003 Locator to XY2F-0002 Crimping Tool, both of which are sold separately, and set the selector dial of the Crimping Tool to 6 for the XS5U-□□21 (XS2U-□□21) and to 7 for the XS5U-□□22 (XS2U-□□22).
- After mounting the crimping pins to the Locator, fully insert the cores to the crimping pins.
- Squeeze the handle of the Crimp Tool to press-fit the cores to the crimping pins. (Squeeze the handle firmly until the handle automatically returns to the release position.)

#### Wiring

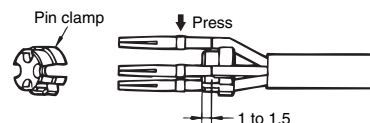

- After press-fitting the cores to the pins, insert the pins into the pin clamp as shown in the illustration. Then make sure that the lead colors correspond to the pin clamp numbers that are identical to the connector pin numbers.

# Assembly Procedure (continued)

## Insertion

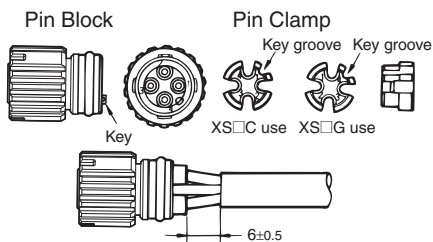

- Tentatively insert the pins to the pin block holes so that the key on the pin block will coincide with the key groove on the pin clamp. Then insert the cable along with the pin clamp.

### Screw-on Connectors

#### Cable End Processing

##### Four-pole Connectors

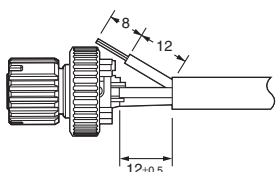

- Loosen the screws on pins 1 to 4 and insert the cores according to the pin numbers.

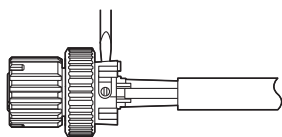

- Use the dedicated Screwdriver (XW4Z-00B)\* and tighten the screws securely so that the cores do not pull out (tightening torque: 0.15 to 0.2 N·m).

##### Five-pole Connectors

- Strip the cable sheath for a total of 15 mm and strip the core covering for 8 mm for the core to connect to pin 5.

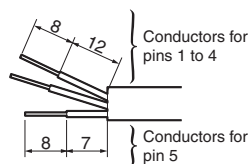

- Connect the core to pin 5 (in the center) first.
- Insert the core from the side of the hold with the tab and tighten the screw securely (tightening torque: 0.15 to 0.2 N·m), and then cut off the excess wire with wire cutters.

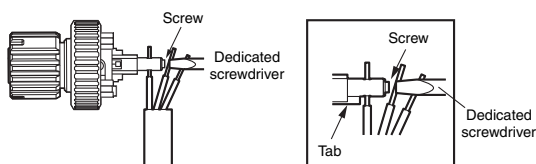

- Bend the cable as shown below, attached the enclosed insulation cap, and then strip the other cores.

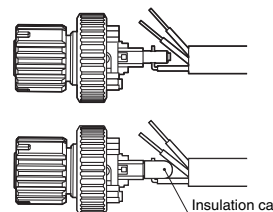

- Connect the cores to pins 1 to 4.

#### Connecting Shielded Cables to Five-pole Connectors

- Place the insulation tub on the drain line of the shield and connect it to the terminal.
- Tighten the screw and then check visually to see if there is insulation between the cores.

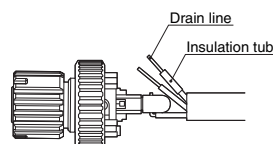

- Connect the cores to pins 1 to 4.

- \* When tightening the screws, use the dedicated XW4Z-00B Screwdriver that matches with the screw-slot dimensions.

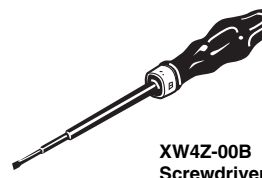

XW4Z-00B Screwdriver

## 4. Inserting Pin Block

### Pin Block (Soldering Model)

### Cover (Straight Model)

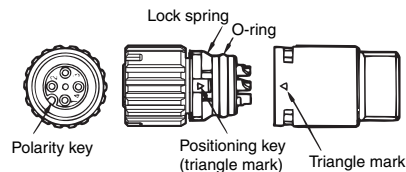

### (Crimping Model)

### (Angled Model)



- Mount the cover to the pin block so that the triangle mark on the pin block will coincide with the triangle mark on the cover.
- If the cover is used for an Angled model, the relationship between the position of the polarity key on the engaged side and cable connection direction will be determined by the direction in which the positioning key is inserted into the cover, which can be rotated by 90°.
- Fully insert the positioning key until the positioning key is hidden by the casing.

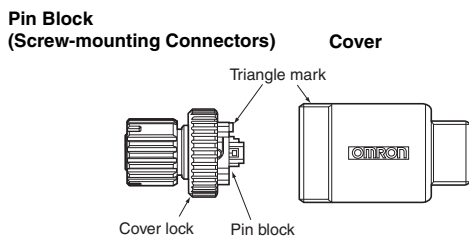

- Align the triangular marks on the pin block and cover and insert the pin block into the cover.
- Press them together firmly (0.39 to 0.49 N·m) until the pin block does not come out of the cover.

### 5. Mounting Cap

- After mounting the cover to the pin block and the cover snaps into place, tighten the cap securely by hand within a torque of 0.39 and 0.49 N·m.

**Note:** If the cap is not tighten securely enough, the degree of protection (IP67) may not be maintained or vibration may cause the cap to become loose. Do not tighten the cap with pliers or similar tools; they may damage the cap.

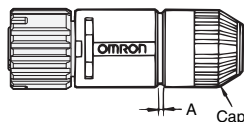

- After fully tightening the cap, length A should be approximately one of the following according to the cable external diameter and the Connector model.

Connector	Cable external diameter (mm)			
	6 mm	5 mm	4 mm	3 mm
For 6-mm-dia. cable	1	0	---	---
For 4-mm-dia. cable	---	2	1	---
For 3-mm-dia. cable	---	---	2	1

### 6. After Assembly

- Confirm the insulation between cores after completing assembly.

### Recommended Cables

When connecting a commercially available cable to a connector assembly, use a cable with an outside diameter of 3 to 6 mm and core sizes of 0.18 to 0.75 mm<sup>2</sup> for crimping connectors and 0.5 mm<sup>2</sup> maximum for soldering connectors.

### Connector Arrangement

For safety, when constructing a connection system between a Sensor and panel with a connector, make sure that the connector plug is on the Sensor side and the connector socket is on the panel side (i.e., the female pins are located on the power-supply side).

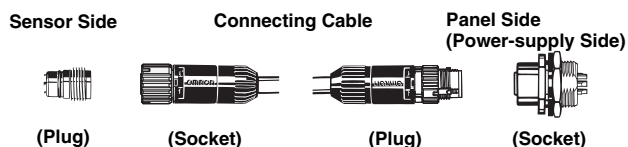

## Connecting the XS5

### 1. Connecting the XS5 Plug and Socket

- Align the projection on the plug cover with the polarity key on the socket, then insert the plug all the way in.

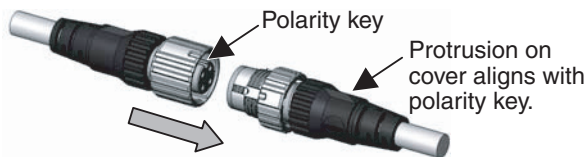

- Hold the knurled socket grip, then insert the projection on the plug into the groove of the socket.



- Turn the knurled grips of the socket clockwise approximately 45 degrees in respect to the plug. A click will indicate that the Connectors are locked. The locking condition can also be confirmed by the alignment marks on the plug and socket.

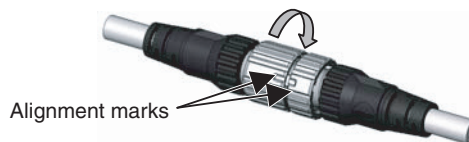

### 2. Connecting the XS5 and XS2

- Align the projection on the plug cover with the polarity key on the socket, then insert the plug all the way in.
- In the same way as when connecting two XS2 Connectors, screw the knurled grip in the clockwise direction.
- Use your fingers to tighten the Connectors sufficiently.

# Accessories

## ■ Connector Covers

### Water-resistant Covers

XS2Z-11

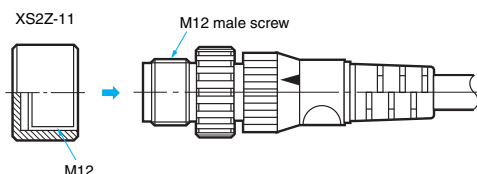

XS2Z-22

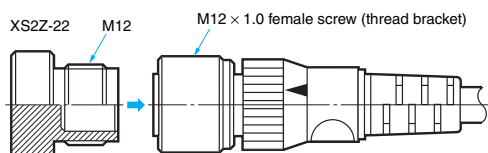

The Water-resistant Cover ensures IP67.

When mounting the Water-resistant Cover to a Connector, be sure to apply a torque range between 0.39 and 0.49 N·m to tighten the Water-resistant Cover.

Model	Minimum order	Material	Suitable connector	
			Model	Mounting portion
XS2Z-11	50	Brass/nickel plated	XS2G/XS2H/XS2M/XS2R/XS2W/ XS5G/XS5H/XS5M/XS5R/XS5W	M12 male screw
XS2Z-22			XS2C/XS2R/XS2F/XS2P/XS2W/ XS5C/XS5R/XS5F/XS5P/XS5W/XW3D	M12 female screw (thread bracket)

### Dust Covers

XS2Z-13

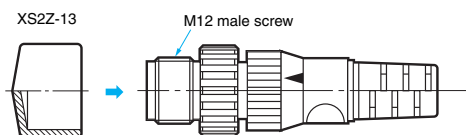

XS2Z-15/XS2Z-14

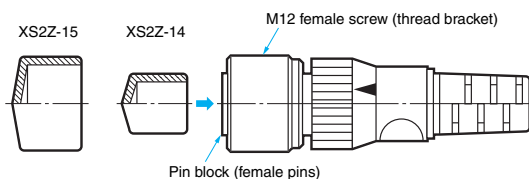

The Dust Cover is for dust prevention and does not ensure IP67 degree of protection.

When mounting the Dust Cover to a connector, be sure to press the Dust Cover onto the Connector until the Connector is fully inserted into the Dust Cover.

Model	Minimum order	Material	Suitable connector	
			Model	Mounting portion
XS2Z-13	50	Rubber/black	XS2G/XS2H/XS2M/XS2R/XS2W/ XS5G/XS5H/XS5M/XS5R/XS5W	M12 male screw
XS2Z-14			XS2C/XS2R/XS2F/XS2P/XS2W/ XS5C/XS5R/XS5F/XS5P/XS5W/XW3D	Pin block (female pins)
XS2Z-15				M12 female screw (thread bracket)

### Sputter Protective Cover

XS2Z-31

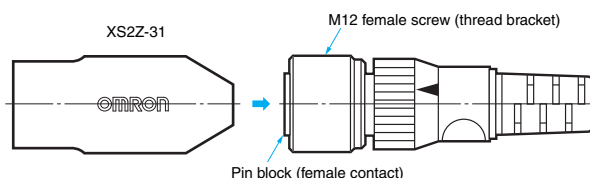
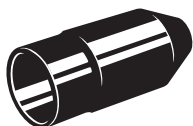

The Sputter Protective Cover protects the connector from weld spatter.

Make sure it covers the entire connector.

Model	Material	Applicable connector
XS2Z-31	Silicone rubber/black	XS2F/XS2H/XS2W XS5F/XS5H/XS5W

# Safety Precautions

## Precautions for Correct Use

Do not use the Connectors in an atmosphere or environment that exceeds the specifications.

### Connector Connection and Disconnection

- When connecting or disconnecting Connectors, be sure to hold the Connectors by hand.
- Do not hold the cable when disconnecting Connectors.
- When mating Connectors, be sure to insert the plug all the way to the back of the socket before attempting to lock the Connectors.
- Do not use tools of any sort to mate the Connectors. Always use your hands. Pliers or other tools may damage the Connectors.
- When mating the Connectors to XS2, XS5 or other M12 Connectors, tighten the lock by hand to a torque of 0.39 to 0.49 N·m.
- When disconnecting Connectors, be sure to loosen the thread brackets first. Do not loosen the caps.
- Thread brackets must be loosened in the cutout direction.

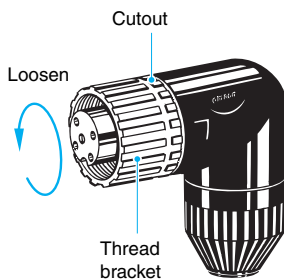

## General Precautions

- Do not pull excessively on the Connectors or cables. Do not install the Connectors or cables in any way that would place a load directly on the mating section or cable connections. Doing so can damage the Connectors or break the wires inside the cables.
- Install the Connectors and cables where they will not be stepped on to prevent the wires inside the cables from being broken and to prevent the Connectors from being damaged. If the Connectors or cables must be installed where they might be stepped on, protect them with covers.
- Refer to the specifications for your cables before bending the cables and do not bend them past their minimum bending radius.
- Cables supplied by Omron should not be bent near the base of the unit and must have a minimum radius of 40 mm.
- If sensors or switches are not attached during installation, protect the mating surface of the Connector with a XS2Z-22 Waterproof Cover or XS2Z-14/15 Dust Cover.

## Wiring

- Always confirm wiring diagrams before wiring sensors, limit switches, or other devices.
- Lay the cables so that external force is not applied to the Connectors. Otherwise, the degree of protection (IP67) may not be achieved.

## Degree of Protection

- Do not impose external force continuously on the joints of pin blocks and covers, otherwise the Connectors may not keep their proper degree of protection (i.e., IP67).
- The degree of protection of Connectors (IP67) is not for a fully watertight structure. Do not use the Connectors underwater.
- Do not step on or place any objects on the Connectors. Doing so may damage the Connectors.



# Smartclick XS5 - Problem Solving

## 1

Problem	Solution
It is troublesome to screw the connectors together.	<b>It's a twist-and-click connection.</b> An innovative new lock structure makes connection extremely simple. The lock mechanism is internal, so it will no longer become jammed by sputtered fluids or dust. Also the use of a movable lock bolt makes it possible to connect the Smartclick XS5 to a screw-type M12 connector.

All combinations are connectable.

	XS5 Smartclick Plug Connector	M12 plug connector
XS5 Smartclick Socket Connector	Twist-and-click connection	Screw connection
M12 socket connector	Screw connection	Screw connection

## 2

Problem	Solution
There's nothing to tell you that it's connected.	<b>The Smartclick XS5 "clicks" to tell you it's connected.</b> A positive clicking feel tells you for sure that the Connector is securely locked. 

## 3

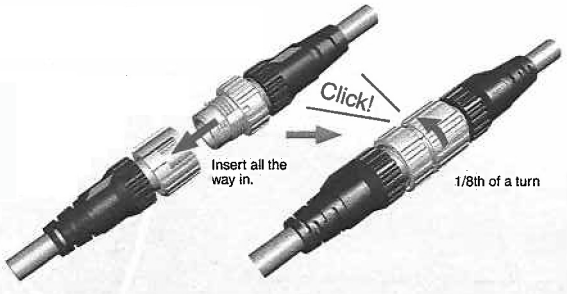
Problem	Solution
It's difficult to keep track of locking torque values.	<b>Locking is done with approximately 1/8th of a turn.</b> The Smartclick XS5 has the industry's shortest locking rotation of 1/8th of a turn. There's no need to keep track of locking torque, and this greatly reduces time and effort when wiring. 

## 4

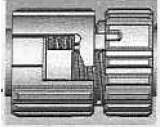
Problem	Solution
The connection sometimes vibrates loose.	<b>A bayonet lock mechanism is used.</b> By using a bayonet mechanism, which is a common locking method, the Smartclick XS5 eliminates any concerns about loosening. 

**ALL DIMENSIONS SHOWN ARE IN MILLIMETERS.**  
To convert millimeters into inches, multiply by 0.03937. To convert grams into ounces, multiply by 0.03527.

**OMRON AUTOMATION AND SAFETY • THE AMERICAS HEADQUARTERS** • Schaumburg, IL USA • 847.843.7900 • 800.556.6766 • [www.omron247.com](http://www.omron247.com)

---

**OMRON CANADA, INC. • HEAD OFFICE**  
Toronto, ON, Canada • 416.286.6465 • 866.986.6766 • [www.omron247.com](http://www.omron247.com)

**OMRON ELECTRONICS DE MEXICO • HEAD OFFICE**  
México DF • 52.55.59.01.43.00 • 001.800.556.6766 • [mela@omron.com](mailto:mela@omron.com)

**OMRON ELECTRONICS DE MEXICO • SALES OFFICE**  
Apodaca, N.L. • 52.81.11.56.99.20 • 001.800.556.6766 • [mela@omron.com](mailto:mela@omron.com)

**OMRON ELETRÔNICA DO BRASIL LTDA • HEAD OFFICE**  
São Paulo, SP, Brasil • 55.11.2101.6300 • [www.omron.com.br](http://www.omron.com.br)

**OMRON ARGENTINA • SALES OFFICE**  
Cono Sur • 54.11.4783.5300

**OMRON CHILE • SALES OFFICE**  
Santiago • 56.9.9917.3920

**OTHER OMRON LATIN AMERICA SALES**  
54.11.4783.5300

---

**OMRON EUROPE B.V.** • Wegalaan 67-69, NL-2132 JD, Hoofddorp, The Netherlands. • Tel: +31 (0) 23 568 13 00 • Fax: +31 (0) 23 568 13 88 • [www.industrial.omron.eu](http://www.industrial.omron.eu)