

20W

DC-DC CONVERTER

The JMR20 series is a range of ultra-compact, regulated PCB-mount medical DC-DC converters which offers single and dual output voltages ranging from 5 to 15VDC. Housed in a 40.6 x 25.4mm (1" x 1.6") plastic case, the JMR20 series features a 4:1 input voltage range and offers a $\pm 10\%$ output trim on single output versions. Its low no load power increases efficiency and extends runtime in battery powered applications. The JMR20 series features worldwide medical approvals, 2 x MOPP 5kVAC reinforced isolation and extremely low leakage currents benefitting system designers with easy integration into a wide range of BF and CF rated medical applications including imaging, patient monitoring, surgical equipment, patient treatment and dentistry.



Features

- Regulated single & dual outputs from 5 to 30VDC
- 4:1 input range
- Compact 40.6 x 25.4mm (1" x 1.6") PCB mount package
- Low no-load power
- 10% trim on single output versions
- IEC60601-1 medical safety agency approvals
- 5kVAC reinforced isolation
- 2 x MOPP at 250VAC
- 2 μ A patient leakage current
- Remote On/Off
- Short circuit, overload & overvoltage protection
- -40°C to +100°C operating temperature
- 3 year warranty

Dimensions

40.6 x 25.4 x 10.2mm (1.6" x 1.0" x 0.4")

Applications



Healthcare



Home Healthcare



Industrial Electronics



Medical Diagnostics

More Resources

Click the link or scan the code

[→ xppower.com](https://www.xppower.com)



Models & Ratings

Model Number	Input Voltage	Output Voltage ⁽¹⁾	Output Current	Efficiency ⁽³⁾	Input Current ⁽⁴⁾		Maximum Capacitive Load
					No Load	Full Load	
JMR2024S05	24V (9.0-36.0V)	5V	4000mA	88.5%	15mA	940mA	5000 μ F
JMR2024S12		12V	1670mA	88.5%	15mA	945mA	850 μ F
JMR2024S15		15V	1330mA	89.0%	15mA	935mA	700 μ F
JMR2024D05		$\pm 5V$	$\pm 2000mA$	86.0%	15mA	970mA	$\pm 2500\mu F$
JMR2024D12		$\pm 12V$	$\pm 833mA$	88.5%	15mA	940mA	$\pm 500\mu F$
JMR2024D15		$\pm 15V$	$\pm 667mA$	89.0%	15mA	935mA	$\pm 350\mu F$
JMR2048S05	48V (18.0-75.0V)	5V	4000mA	89.0%	15mA	465mA	$\pm 5000\mu F$
JMR2048S12		12V	1670mA	88.5%	15mA	470mA	850 μ F
JMR2048S15		15V	1330mA	89.0%	15mA	465mA	700 μ F
JMR2048D05		$\pm 5V$	$\pm 2000mA$	86.0%	15mA	485mA	$\pm 2500\mu F$
JMR2048D12		$\pm 12V$	$\pm 833mA$	88.5%	15mA	470mA	$\pm 500\mu F$
JMR2048D15		$\pm 15V$	$\pm 667mA$	88.9%	15mA	470mA	$\pm 350\mu F$

Notes:

1. Dual output models can be used to provide a single output of 10V, 24V or 30V.
2. Specifications noted using nominal input voltage and full load at 25°C unless otherwise stated.

3. Measured at full load and nominal input voltage.

4. No load input current reduces to <2mA when module is inhibited.

Input

Characteristic	Minimum	Typical	Maximum	Units	Notes & Conditions
Inrush Voltage Range	9		36	VDC	24V nominal
	18		75		48V nominal
Inrush Current			80	A	At nominal input voltage
Input Reflected Ripple		30		mA pk-pk	Through 12 μ H inductor and 47 μ F capacitor
Input Surge			50	VDC for 100ms	24V nominal
			100		48V nominal
Input Current Remote On/Off		2.5	8.0	mA	Idle current using remote "Off". See models and ratings table for no load input current with module "On"
Recommended Input Fuse (Slow blow)		4.0		A	24V nominal
		2.0			48V nominal

Output

Characteristic	Minimum	Typical	Maximum	Units	Notes & Conditions
Output Voltage	5		30	VDC	See Models & Ratings table
Output Voltage Adjustment	-10		+10	%	See application note
Initial Set Accuracy			± 1	%	At full load
Minimum Load	0			%	No minimum load required
Line Regulation			± 0.5	%	From min to max input voltage
Load Regulation			± 1.0	%	From 0-100% load
Cross Regulation			± 5	%	Dual output, when one output at 25% load other is varied from 10% to full load
Transient Response Deviation	3		5	%	Deviation recovering to within 1% in 250 μ s for 25% load change at 0.1A/ μ s
Ripple & Noise			100/150	mV pk-pk	5V/12-15V outputs, 20MHz bandwidth, measured using 10 μ F ceramic capacitor at nominal Vin
Short Circuit Protection	Continuous, hiccup mode with auto recovery				
Maximum Capacitive Load	See Models & Ratings table				
Temperature Coefficient			0.02	%/ °C	
Overload Protection	120		180	%	At nominal input voltage
Remote On/Off	Output is on if remote on/off (pin 6) is open with reference to pin 2 -Vin Output turns off if 2.2 to 12V is applied to remote On/Off (pin 1) or if connected to a current source of 2-4mA. See application note				

General

Characteristic	Minimum	Typical	Maximum	Units	Notes & Conditions
Efficiency		89		%	See Models & Ratings table
Isolation: Input to Output	5000			VAC	Reinforced insulation, 2 x MOPP, 60s, production test to 5kVAC
Working Voltage			250	VAC	
Creepage and Clearance	8			mm	
Isolation Resistance	10 ⁹			Ω	Input to output
Isolation Capacitance		20		pF	Input to output
Leakage Current		2		μ A	264VAC, 60Hz
Power Density			1.9	Wcm ³	
Mean Time Between Failure		520		khrs	MIL-HDBK-217F, +25°C GB
Switching Frequency		275		kHz	
Weight		22.0 (0.05)		g (lb)	
Solder Profile			260	°C	Waveflow. 1.5mm (0.05") from case, 10 seconds max.
Case Material	Non conductive black plastic UL94V-0 rated				
Potting Material	Silicone, UL94V-0 rated				
Pin Material	Solder coated brass dia. 0.5mm				
Water Wash	Use deionized water. Dry thoroughly				

Environmental

Characteristic	Minimum	Typical	Maximum	Units	Notes & Conditions
Operating Temperature	-40		+100	°C	See derating curve
Storage Temperature	-55		+125	°C	
Case Temperature			+110	°C	At nominal input voltage
Humidity Operating & Storage	5		95	%RH	Non-condensing
Cooling	Natural convection				
Operating Altitude			5000	m	Transport altitude 10km

Safety Approvals

Safety Agency	Standard	Notes & Conditions
UL	ANSI/AAMI ES60601-1, UL62368-1	
CSA	CSA C22.2 No. 60601-1	
TUV	EN60601-1	
CB	IEC/EN60601-1	
CE	Meets all applicable directives	
UKCA	Meets all applicable legislation	

EMC: Emissions

Phenomenon	Standard	Test Level	Notes & Conditions
Conducted	EN55011	Class B	See application notes
Radiated	EN55011	Class B	

EMC: Immunity

Phenomenon	Standard	Test Level	Criteria	Notes & Conditions
Medical Device EMC	EN60601-1-2: 2015			IEC60601-1-2:2014 Ed4.0
ESD Immunity	EN61000-4-2	±6kV	A	Contact
		±8kV		Air
Radiated Immunity	EN61000-4-3	10V/m	A	
EFT/Burst	EN61000-4-4	±2kV	A	External component required, see application notes
Surge	EN61000-4-5	±2kV	A	External component required see application notes
Conducted Immunity	EN61000-4-6	10Vrms	A	
Magnetic Fields	EN61000-4-8	100A/m	A	

Mechanical Details

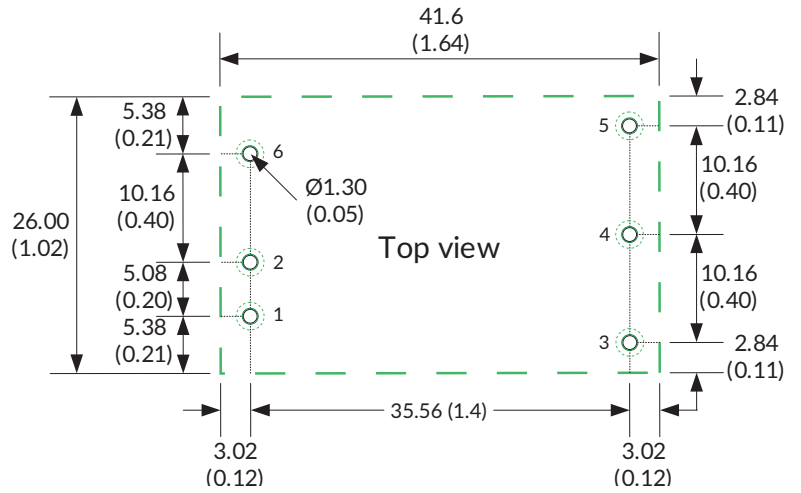
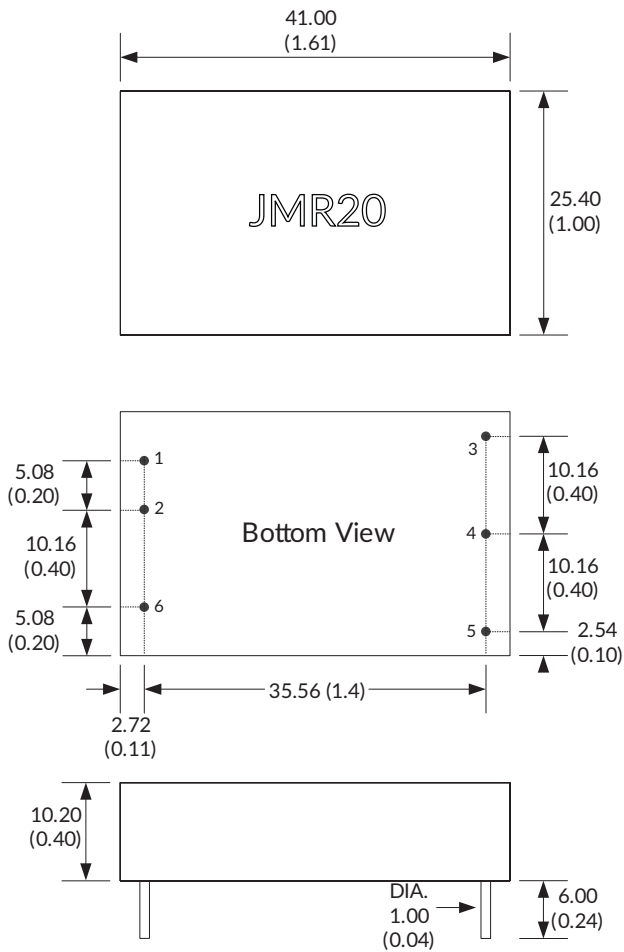

Pin	Pin Connection	
	Single	Dual
1	+Vin	+Vin
2	-Vin	-Vin
3	+Vout	+Vout
4	-Vout	COM
5	Trim	-Vout
6	CTRL	CTRL

Notes:

1. All dimensions are in mm (inches)
2. Weight: 22.0 (0.05) g (lbs) approx.
3. Pin diameter: $\pm 0.002, 0.02 (\pm 0.05, 0.5)$
4. Pin pitch tolerance: $\pm 0.35 (\pm 0.014)$
5. Case tolerance: $\pm 0.5 (\pm 0.02)$

Derating Curve

5V output models

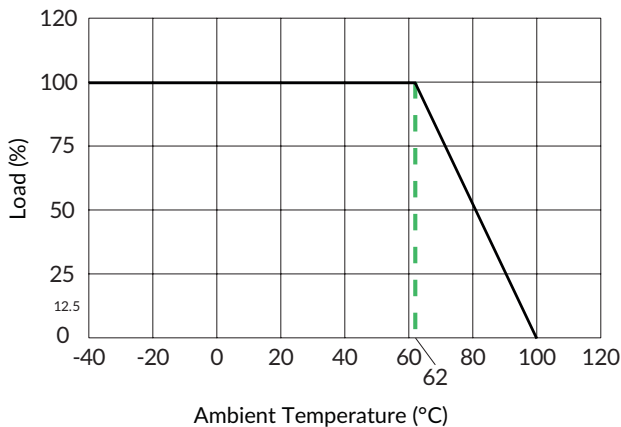

12V and 15V output models

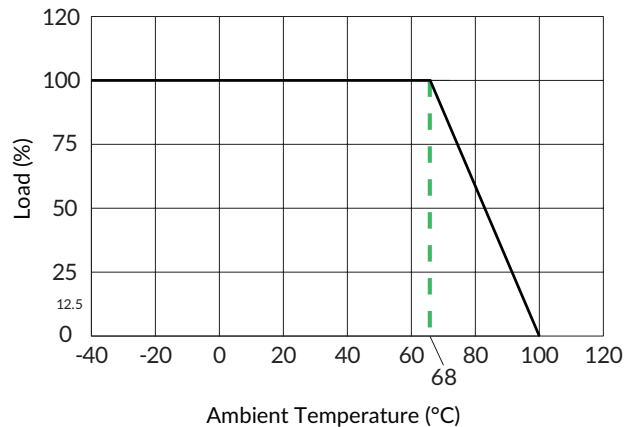

Application Notes

EMC Filter

Circuit 1 for Surge & EFT, 2 for EMI class B.

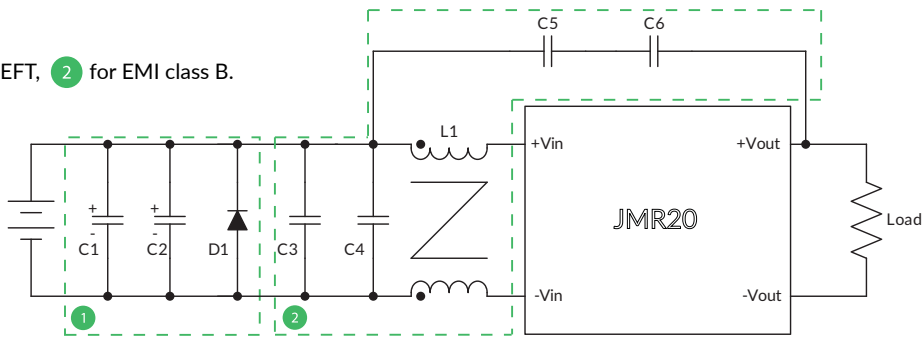

Model Number	C1, C2	D1	C3	C4	L1	C5, C6
JMR2024XXX	NIPPON Chemi-con	SMDJ58A	MLCC, 10 μ F, 50V	Not fitted	LFTBH953-171N-5.2A	100pF/400VAC Y1
JMR2048XXX	KY Series, 220 μ F, 100V	SMDJ120A	MLCC, 2.2 μ F, 100V	MLCC, 2.2 μ F, 100V	LFTBH953-371N-3A	

Trim

Output can be externally trimmed by using the method shown on the tables below. (single output models only)

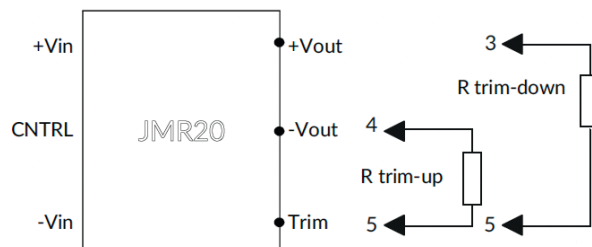

Remote On/Off

Module "On" if pin 6 is open circuit, Module "Off" if pin 6 is connected to current source of 2-4mA or a voltage of 2.2 to 12V is applied to pin 6 WRT pin 2.

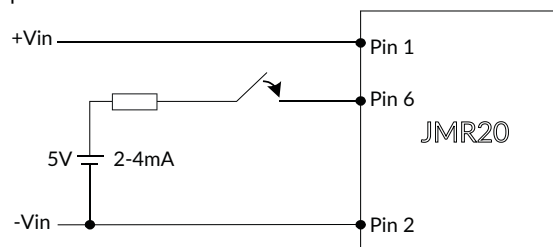

JMR20XXS05

Trim down	1	2	3	4	5	6	7	8	9	10%
Vout=	4.950	4.900	4.850	4.800	4.750	4.700	4.650	4.600	4.550	4.500V
Rtrim-down	214.030	98.592	60.123	40.890	29.351	21.659	16.164	12.044	8.839	6.275K Ω
Trim up	1	2	3	4	5	6	7	8	9	10%
Vout=	5.050	5.100	5.150	5.200	5.250	5.300	5.350	5.400	5.450	5.500V
Rtrim-up	439.080	214.585	139.733	102.304	79.845	64.872	54.176	46.155	39.916	34.924K Ω

JMR20XXS12

Trim down	1	2	3	4	5	6	7	8	9	10%
Vout=	11.880	11.760	11.640	11.520	11.400	11.280	11.160	11.040	10.920	10.800V
Rtrim-down	210.981	111.523	72.540	51.734	38.796	29.972	23.569	18.711	14.899	11.828K Ω
Trim up	1	2	3	4	5	6	7	8	9	10%
Vout=	12.120	12.240	12.360	12.480	12.600	12.720	12.840	12.960	13.080	13.200V
Rtrim-up	1275.493	527.185	330.975	240.515	188.461	154.637	130.894	113.309	99.761	89.004K Ω

JMR20XXS15

Trim down	1	2	3	4	5	6	7	8	9	10%
Vout=	14.850	14.700	14.550	14.400	14.250	14.100	13.950	13.800	13.650	13.500V
Rtrim-down	184.463	93.453	59.044	40.959	29.809	22.246	16.779	12.643	9.405	6.801K Ω
Trim up	1	2	3	4	5	6	7	8	9	10%
Vout=	5.150	15.300	15.450	15.600	15.750	15.900	16.050	16.200	16.350	16.500V
Rtrim-up	1383.154	605.730	386.767	283.530	223.450	184.145	156.426	135.830	119.923	107.268K Ω