

Data Sheet

AR01532MS-SC15-WP-R

PUI Audio's **Mobile Series** line of speakers and receivers is designed for cutting-edge applications such as smart watches and pendants, Wi-Fi enabled security devices and action cameras, mobile radios and smart phones, as well as IoT devices. Each **Mobile Series** product features an IP67-rated face for protection against dust and water ingress.

The 32 ohm 15mm x 6mm **AR01532MS-SC15-WP-R** receiver is designed for high fidelity audio reproduction in near-phone and headphone applications. Spring contacts and a 2mm thickness make mounting easy, even in the thinnest applications.

Features:

- Custom-molded poly cone designed for voice articulation
- High 108 dB output with 179mV in Artificial Ear (1cm)
- High energy neodymium motor
- Only 2 mm thick
- Dustproof and waterproof IP67-rated face

Specifications

Parameters	Values	Units
Rated Input Power	20	mWatts
Max Input Power	30	mWatts
Impedance	32 ± 15%	Ohms
Sensitivity (SPL @ 1kHz) 179mV in Type 3.2 HL Ear	108 ± 3	dB Pa/V
Resonant Frequency (179mV in free air)	400 ± 20%	Hz
Frequency Range	300 ~ 7,000	Hz
Frame Material	PPA	-
Magnet Material	NdFeB	-
Weight	0.5	Grams
Environmental Protection Rating	IP67	-

Specifications (continued)

Buzz, Rattle, etc.	Should not be audible with 20mW sine wave from 300 Hz to 7 kHz	-
Polarity	When positive voltage is applied to the positive terminal, the diaphragm will move outward	-
Operating Temperature	-40 ~ +80	°C

Measurement Method (measured with 179mV, Temperature: 15 ~ 35°C, Relative Humidity: 45%~85%)

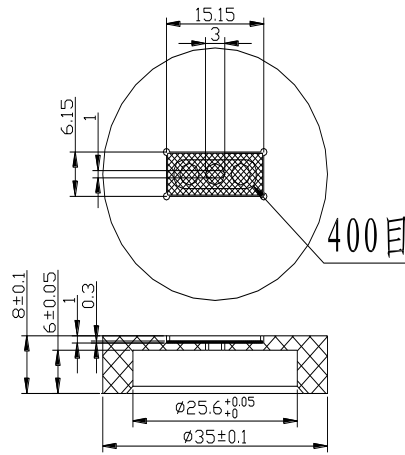

Receiver Test Baffle

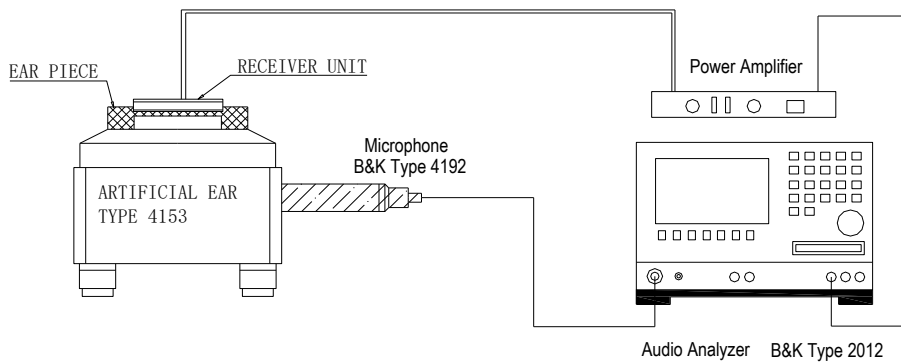

Measurement System

Frequency Response (measured at 179 mV in Type 3.2HL Ear)

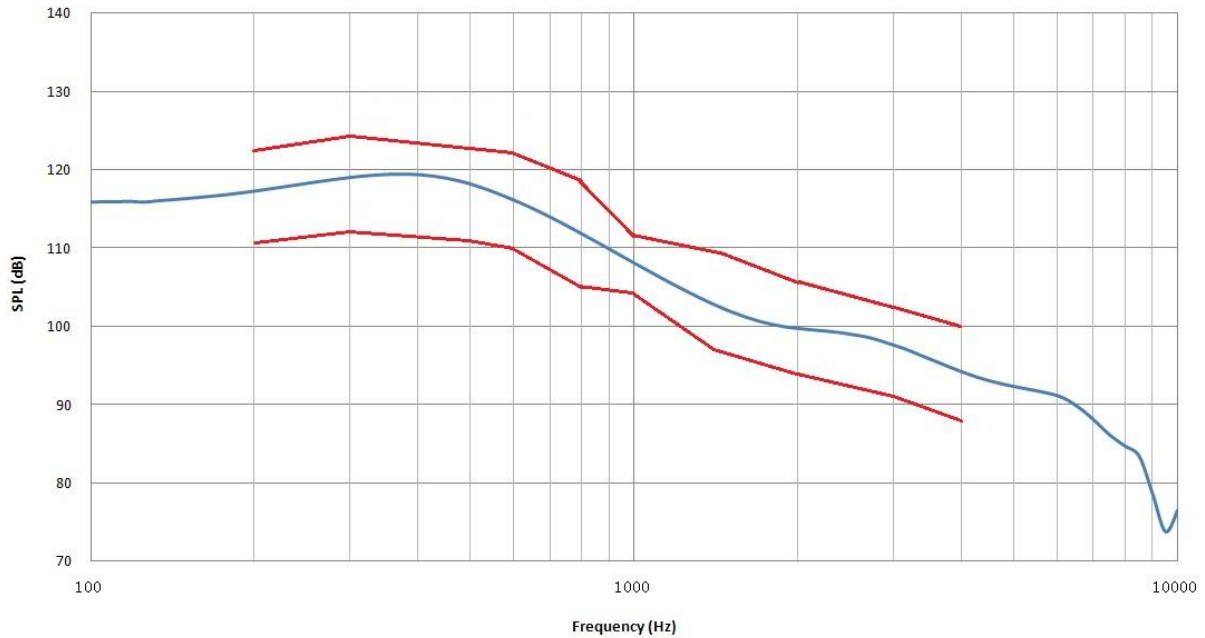

Frequency (Hz)	Lower limit (dB)	Upper Limit (dB)
200	111	123
300	112	124
500	111	123
600	110	122
800	106	118
1000	105	111
1500	97	109
2000	94	106
3000	91	103
4000	88	100

Impedance Response (measured at 179 mV in Type 3.2HL Ear)

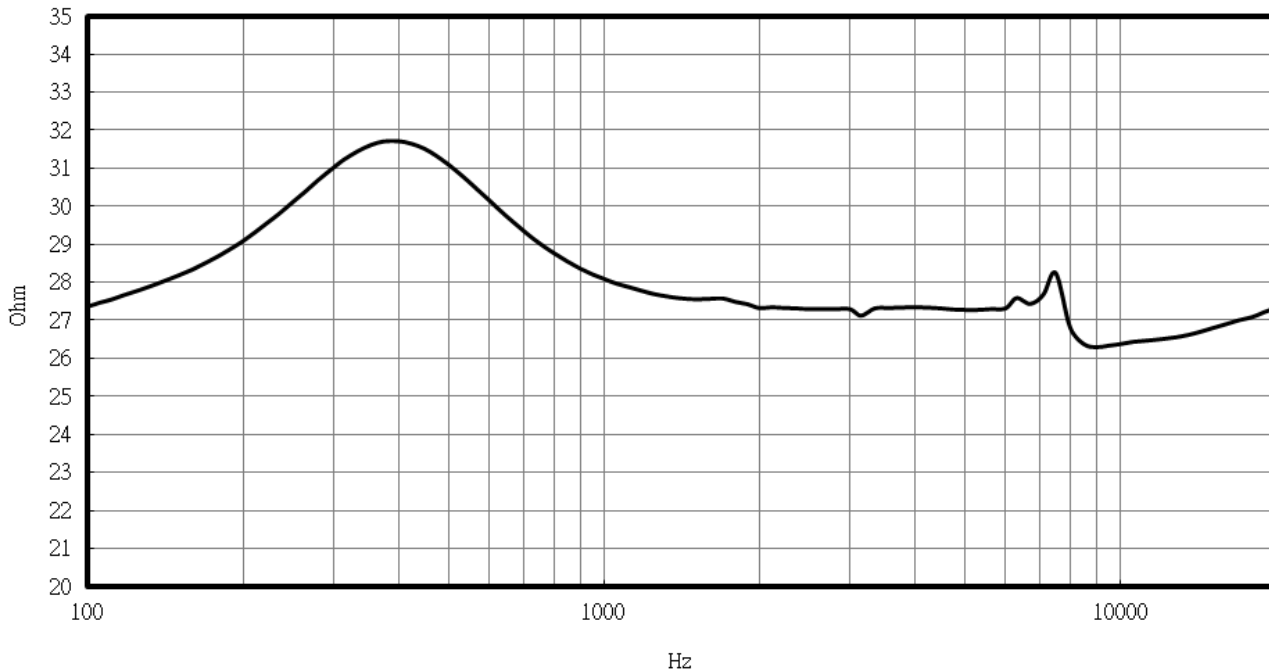

Reliability Testing

Type of Test	Test Specifications
High Temperature Test	96 hours at +80°C ± 3°C followed by three hours in normal room temperature
Low Temperature Test	96 hours at -40°C ± 3°C followed by three hours in normal room temperature
Humidity Test	96 hours at +40°C ± 3°C with relative humidity at 95% followed by 3 hours in normal room temperature
Temperature Cycle Testing	The part shall be subjected to 5 cycles using the following procedure: Low temperature: -40°C±3°C High temperature: +80°C±3°C Cycle: 1 hour/cycle each
Vibration Test	10 to 55 to 10 Hz sine sweep, 15 minutes per cycle @ 5G constant. 2 hours in each axis X, Y, and Z.
Drop Test	Drop the speakers onto a 20mm thick board 10 times from a height of 100cm, once each side
Load Test and Max Power Test	White noise is applied at the speakers rated power for 96 hours at room temperature; max power is applied for 1 minute on, 2 minutes off; 10 cycles.

After each test, the speaker's SPL shall be ±3 dB of the original SPL

Dimensions

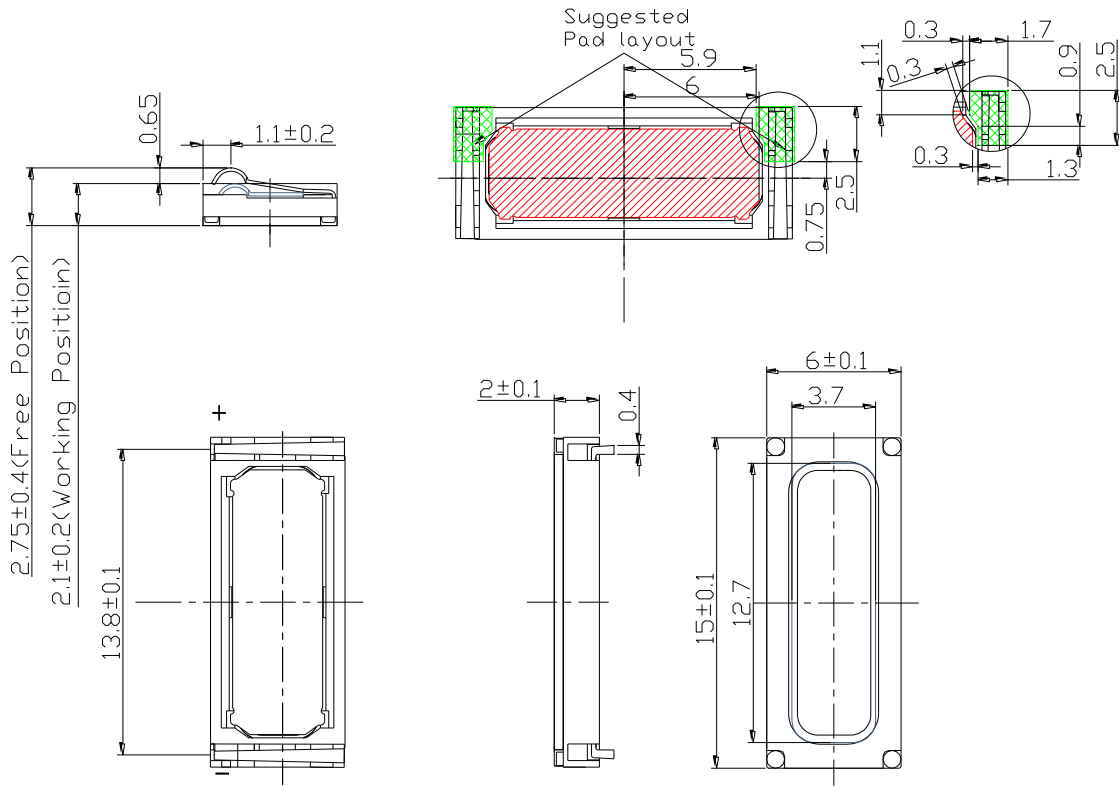

Packaging

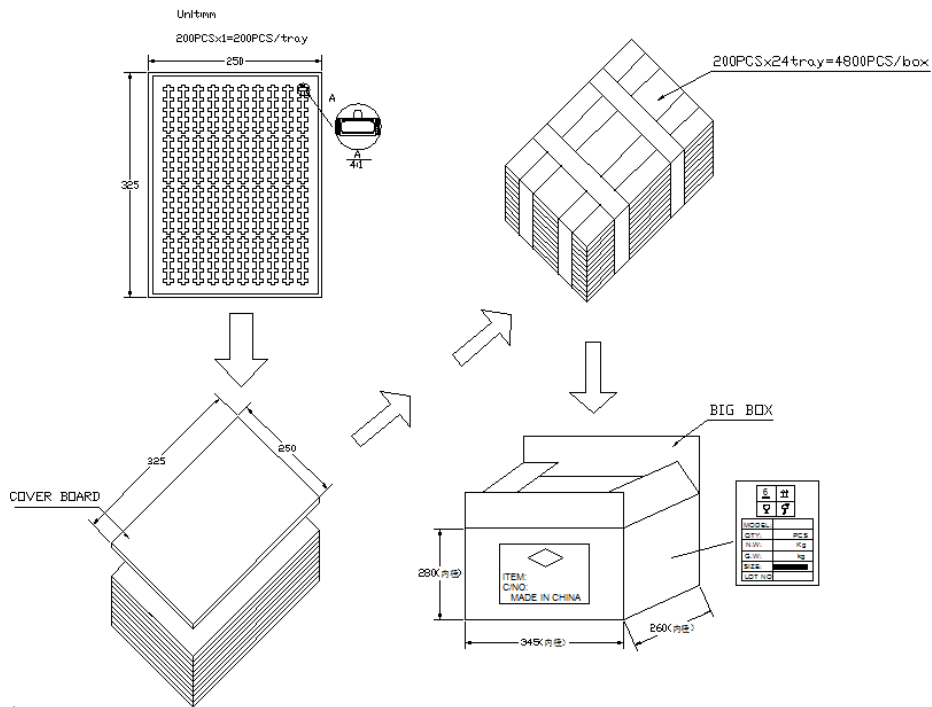

Specifications Revisions

Revision	Description	Date
-	Released from Engineering	11/20/2017

Note:

1. Unless otherwise specified:
 - A. All dimensions are in millimeters.
 - B. Default tolerances are $\pm 0.5\text{mm}$ and angles are $\pm 3^\circ$.
2. Specifications subject to change or withdrawal without notice.
3. This part is RoHS 2011/65/EU Compliant.