

SPECIFICATION

Part No.	:	DXP.01.A
Product Name	:	SMD L1/L2 SAW Diplexer For GPS/GALILEO L1, GLONASS L2 & BeiDou B2
Features	:	L2 1222.7625 / L1 1575.42MHz SAW Diplexer SMT Direct Mount Compact Size 5*5*1.7mm Low Insertion Loss In band High Isolation Port to Port RoHS Compliant



1. Introduction

The Taoglas DXP.01.A is an advanced compact SAW diplexer for use in any navigation system application using the GPS/GALILEO L1, GLONASS L2 and BeiDou B2 bands.

The diplexer is designed to function as both a bandpass filter for each band and to either split one path into two or to combine both bands back into one RF feed. For example, a customer who wanted to use passive dual band antenna elements would need to implement a diplexer in some cases to split both bands out into separate paths. It is also designed to isolate and reject any unwanted GPS/GALILEO signals from getting to the application port.

It is housed in a compact 5*5*1.7mm over-molded laminate package and is easy to integrate using SMT process mounting directly onto the target PCB.

Contact your regional Taoglas sales office for more information or support.

2. Specification

L1 Band GPS/GALILEO			
	Min.	Typ.	Max.
Center Frequency (MHz)	-	1575.42	-
Insertion Loss (dB)	-	3.3	3.8
Amplitude Ripple (dB)	-	0.1	1.0
Return Loss (dB)	-	-12	-8.5
Attenuation (Reference level from 0dB)			
824 ~ 960 (MHz)	25	47	-
1500 ~ 1525.42 (MHz)	8	19	-
1625.42 ~ 1650 (MHz)	8	16	-
1710 ~ 2170 (MHz)	25	34	-
L2 Band GLONASS and B2 Band BeiDou			
	Min.	Typ.	Max.
Center frequency (MHz)	-	1222.7625	-
Insertion Loss (dB)	-	4.1	4.8
Amplitude Ripple (dB)	-	0.9	1.8
Return Loss (dB)	-	-12	8.5
Attenuation (Reference level from 0dB)			
464 ~ 600 (MHz)	25	32	-
1110 ~ 1130 (MHz)	16	23	-
1330 ~ 1450 (MHz)	28	37	-
1500 ~ 1820 (MHz)	25	30	-
L1 Band GPS/GALILEO, L2 Band GLONASS and B2 Band BeiDou			
	Min.	Typ.	Max.
Isolation (1196.9~1248.625MHz)	22	36	-
Isolation (1574.22~1576.62 dB)	22	33	-
Environmental			
Operating Temperature	-40°C to 85°C		
Storage Temperature	-40°C to 85°C		
Input power Level	10 dBm		
DC Voltage	3 V		

3. Measurement circuit

HP Network analyzer

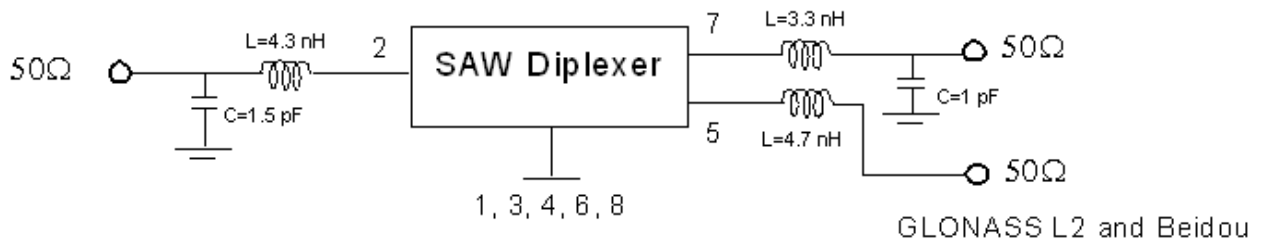

3.1 Test setup

Band 1 (L1) **Band 2(L2/L5)**



Common Port



3.2 S-Parameter

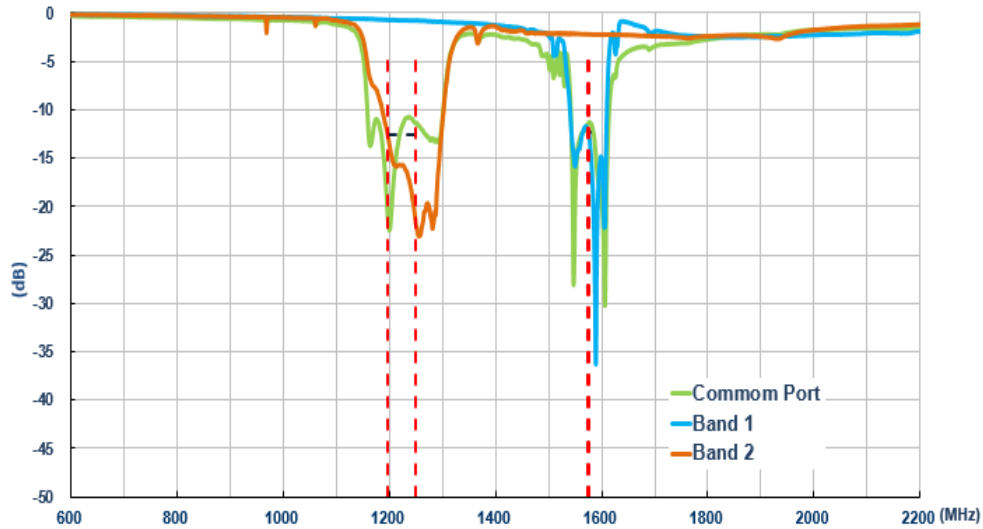

Return Loss (dB)	
Band 1 1574.22~1576.62MHz	Band 2 1196.9~1248.625MHz
<-12.3	<12.6

3.3. Common Port to Band 1 Port _ 1575.42MHz Attenuation

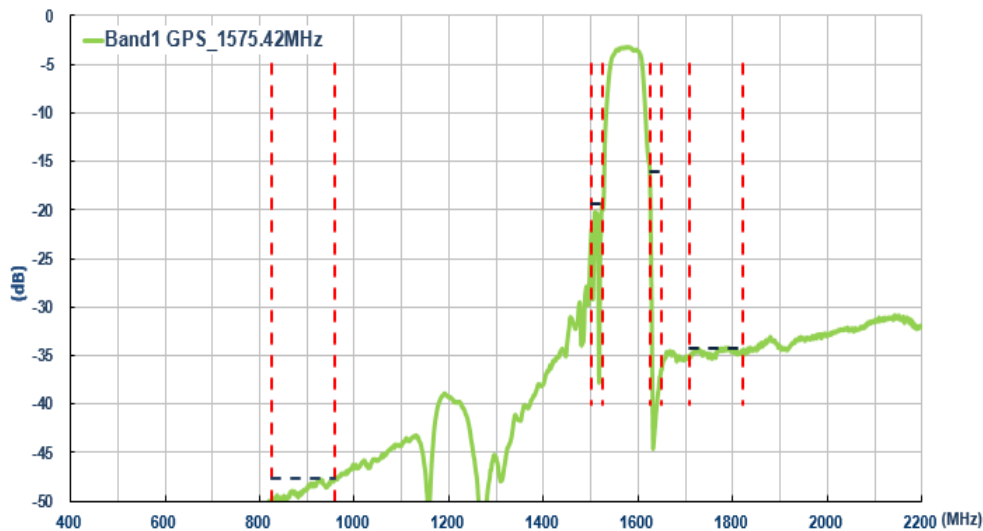

Attenuation (dB)			
824~960MHz	1500~1525.42MHz	1625.42~1650MHz	1710~1820MHz
<-47.6	<-19.4	<-16.1	<-34.2

3.4. Common Port to Band 1 Port _ 1575.42MHz Insertion Loss

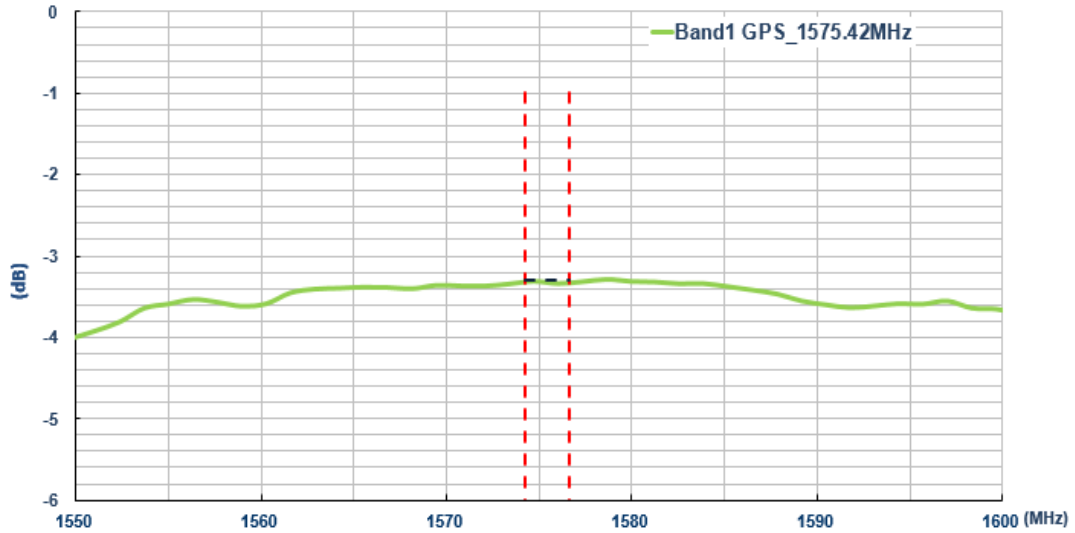

Insertion Loss(dB)
1574.22~1576.62MHz
> -3.3

3.5. Common Port to Band 1 Port _1222.7625MHz Attenuation

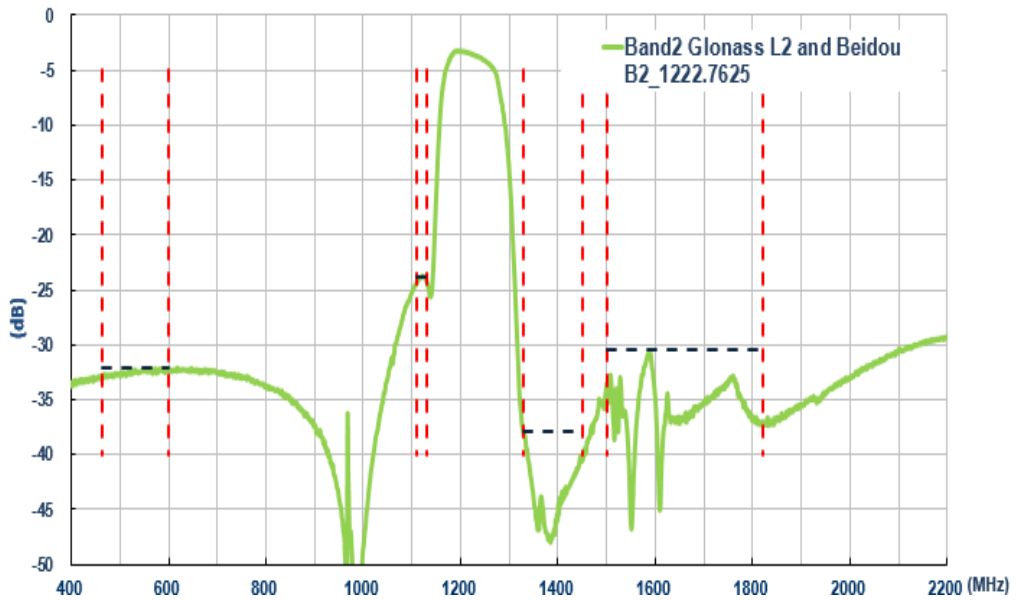

Attenuation (dB)			
464~600MHz	1110~1130MHz	1330~1450MHz	1500~1820MHz
<-32.1	<-23.8	<-37.9	<-30.5

3.6. Common Port to Band 1 Port _1222.7625MHz Insertion Loss

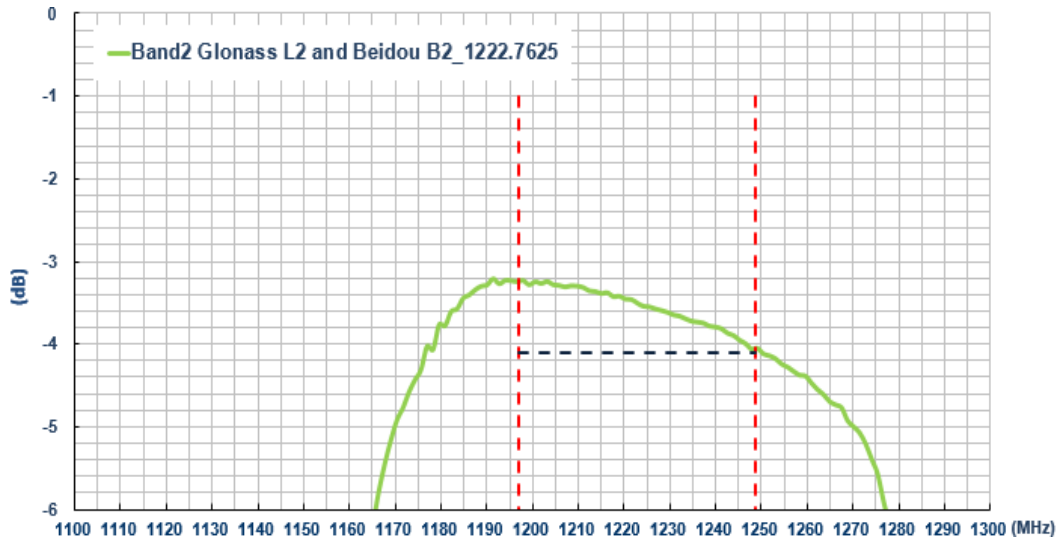

Insertion Loss(dB)
1196.9~1248.625MHz
> -4.1

3.7. Band1 Port – Band2 Port Isolation

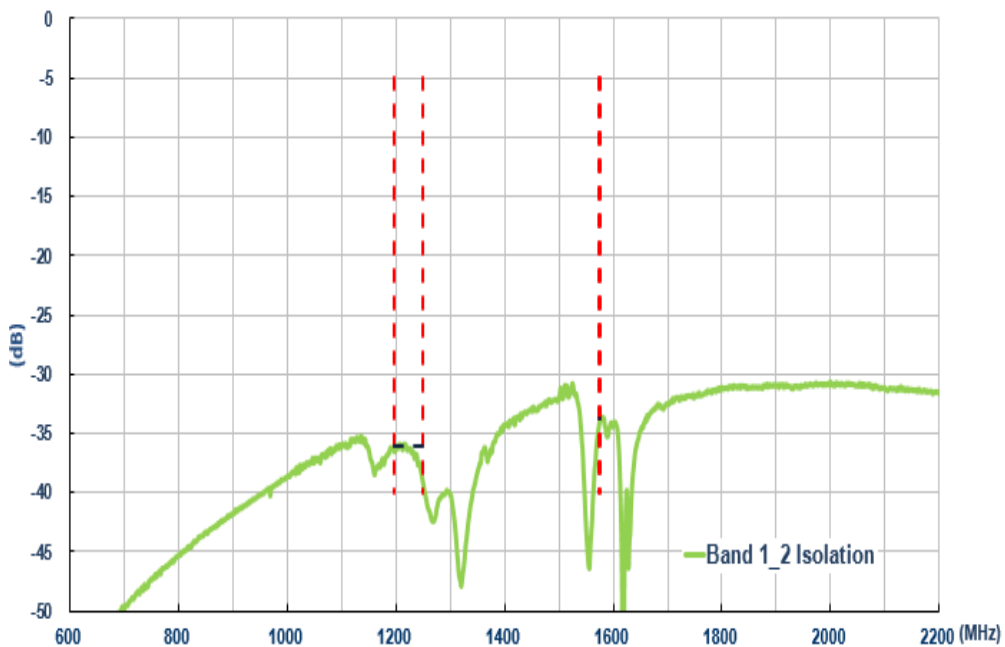

Isolation (dB)	
Band 1 1196.5~1248.625MHz	Band 2 1574.22~1576.62MHz
<-36.1	<-33.8

4. Drawing (Unit: mm)

4.1. Diplexer Drawing

Front View

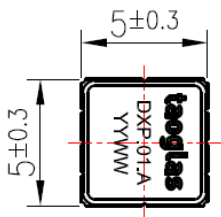

Side View

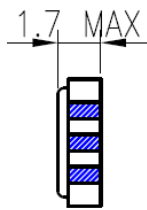

Back View

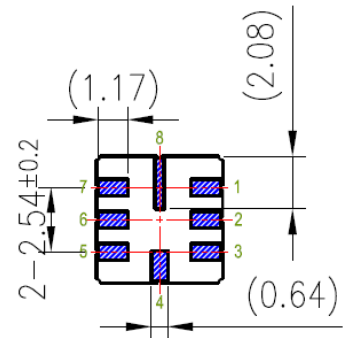

4.2. Foot Print

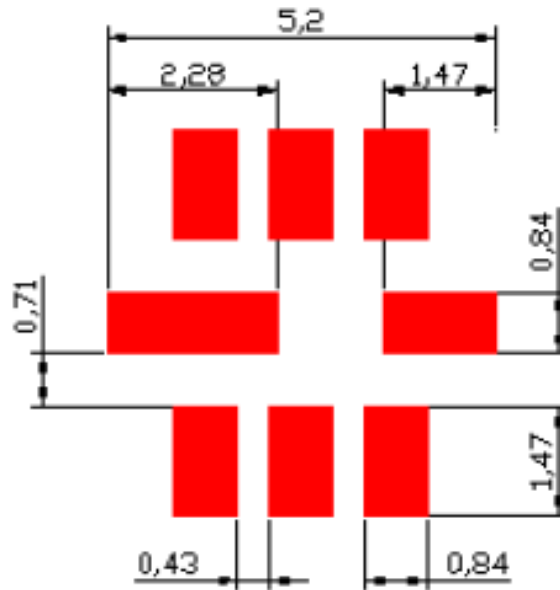

5. Recommended Reflow Profile

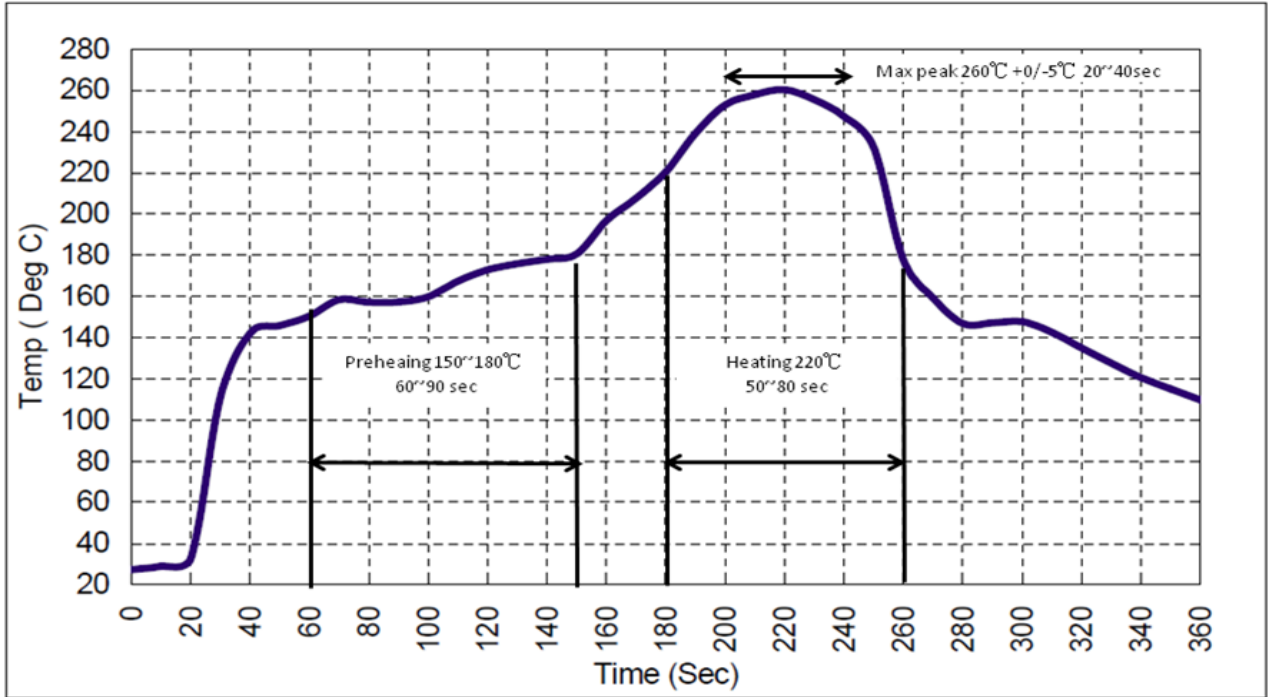

1. Preheating shall be fixed at 150~180°C for 60~90 seconds.
2. Ascending time to preheating temperature 150°C shall be 30 seconds minimum.
3. Heating shall be fixed at 220°C for 50~80 seconds and 260°C as the peak for 20-40 seconds.
4. Time: 2 times.

6. Packaging

Tape Dimension

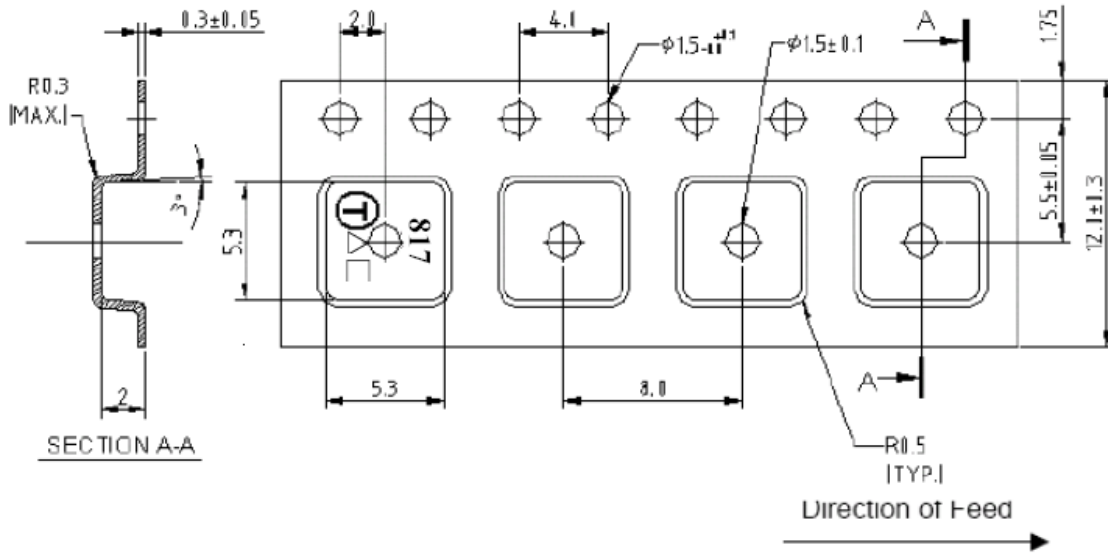

Reel Dimension

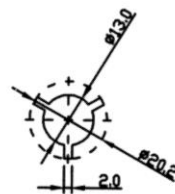
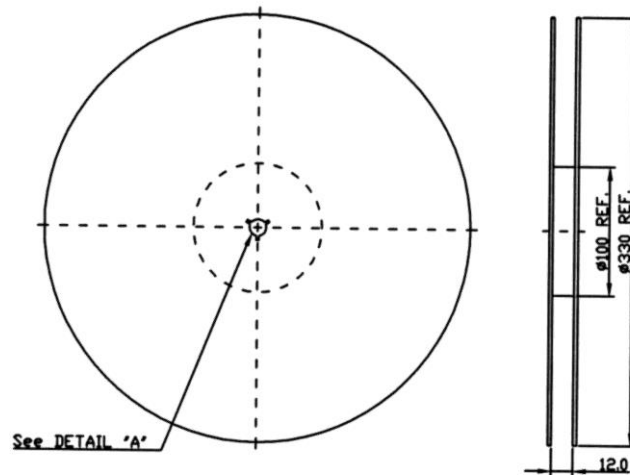

Packaging Detail

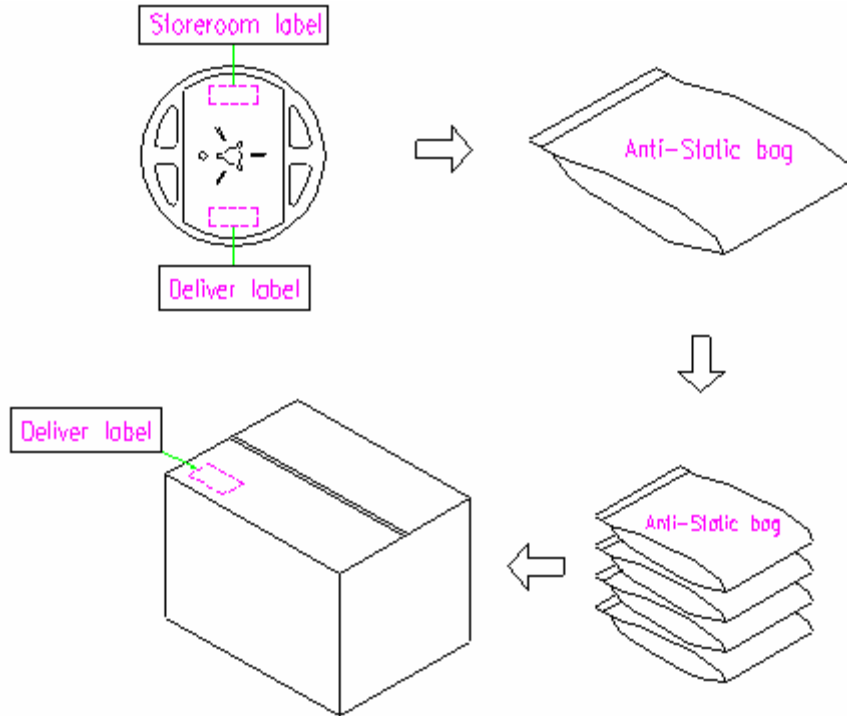

1k pieces per reel, 4 reels per carton.

Taoglas makes no warranties based on the accuracy or completeness of the contents of this document and reserves the right to make changes to specifications and product descriptions at any time without notice. Taoglas reserves all rights to this document and the information contained herein.

Reproduction, use or disclosure to third parties without express permission is strictly prohibited.

Copyright © Taoglas Ltd.

Mouser Electronics

Authorized Distributor

Click to View Pricing, Inventory, Delivery & Lifecycle Information:

[Taoglas:](#)

[DXP.01.A](#)