

5-100526-4 ✓ ACTIVE

Z-PACK | Z-PACK 2mm HM

TE Internal #: 5-100526-4

Coding Key, Reseda Green, Z-PACK 2mm HM

[View on TE.com >](#)



Connectors > Connector Accessories > Connector Hardware

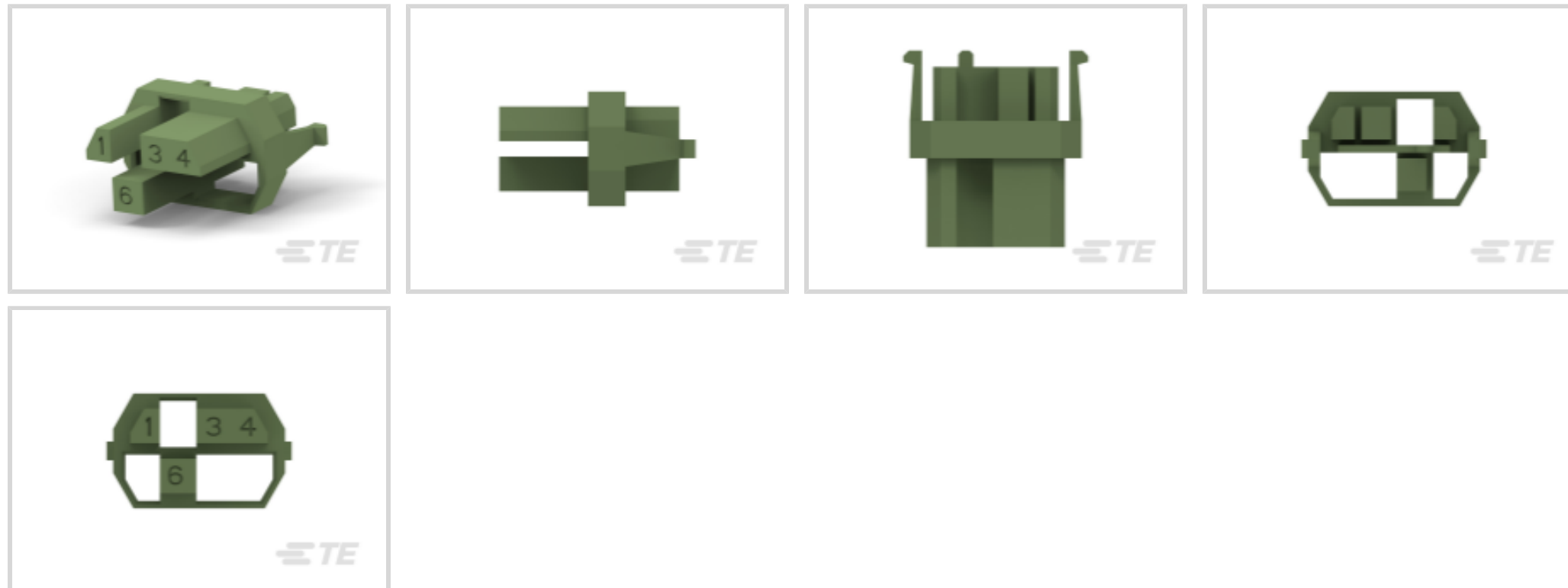

Hardware Accessory Function: **Coding & Keying**

Connector Hardware Accessory Type: **Coding Key**

Primary Product Color: **Reseda Green**

Features

Product Type Features

| | |
|-----------------------------------|-----------------|
| Hardware Accessory Function | Coding & Keying |
| Connector Hardware Accessory Type | Coding Key |

Body Features

| | |
|-------------------------|--------------|
| Connector & Keying Code | 1346 |
| Primary Product Color | Reseda Green |

Usage Conditions

| | |
|---------------------------------|------------|
| Compatible With Connector Style | Receptacle |
|---------------------------------|------------|

Packaging Features

| | |
|--------------------|-----|
| Packaging Quantity | 500 |
| Packaging Method | Bag |

Product Compliance

[For compliance documentation, visit the product page on TE.com>](#)

| | |
|---|---|
| EU RoHS Directive 2011/65/EU | Compliant |
| EU ELV Directive 2000/53/EC | Compliant |
| China RoHS 2 Directive MIIT Order No 32, 2016 | No Restricted Materials Above Threshold |

EU REACH Regulation (EC) No. 1907/2006

Current ECHA Candidate List: JUNE 2024 (241)

Candidate List Declared Against: JUNE 2024 (241)

Does not contain REACH SVHC

Halogen Content

Low Halogen - Br, Cl, F, I < 900 ppm per homogenous material. Also BFR/CFR/PVC Free

Solder Process Capability

Not applicable for solder process capability

Product Compliance Disclaimer

This information is provided based on reasonable inquiry of our suppliers and represents our current actual knowledge based on the information they provided. This information is subject to change. The part numbers that TE has identified as EU RoHS compliant have a maximum concentration of 0.1% by weight in homogenous materials for lead, hexavalent chromium, mercury, PBB, PBDE, DBP, BBP, DEHP, DIBP, and 0.01% for cadmium, or qualify for an exemption to these limits as defined in the Annexes of Directive 2011/65/EU (RoHS2). Finished electrical and electronic equipment products will be CE marked as required by Directive 2011/65/EU. Components may not be CE marked. Additionally, the part numbers that TE has identified as EU ELV compliant have a maximum concentration of 0.1% by weight in homogenous materials for lead, hexavalent chromium, and mercury, and 0.01% for cadmium, or qualify for an exemption to these limits as defined in the Annexes of Directive 2000/53/EC (ELV). Regarding the REACH Regulation, the information TE provides on SVHC in articles for this part number is based on the latest European Chemicals Agency (ECHA) 'Guidance on requirements for substances in articles' posted at this URL: <https://echa.europa.eu/guidance-documents/guidance-on-reach>

Compatible Parts



Also in the Series | Z-PACK 2mm HM

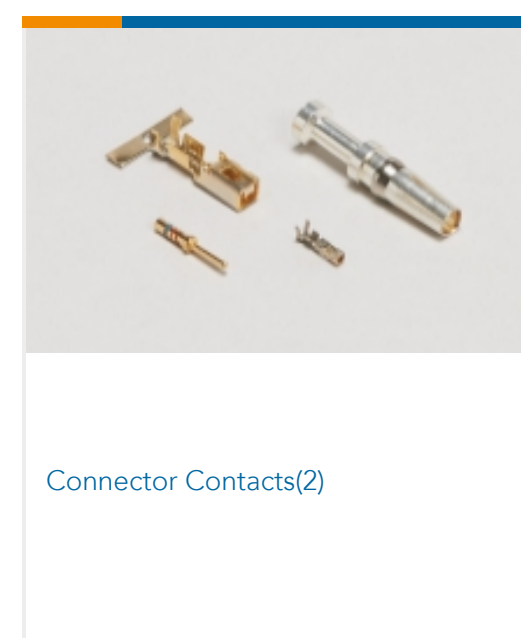
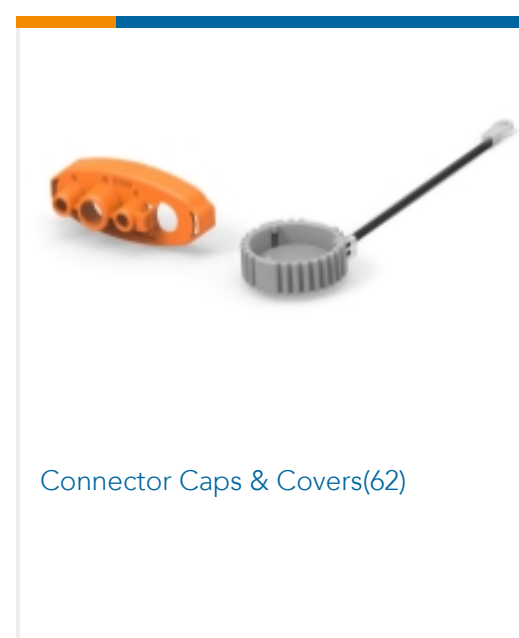
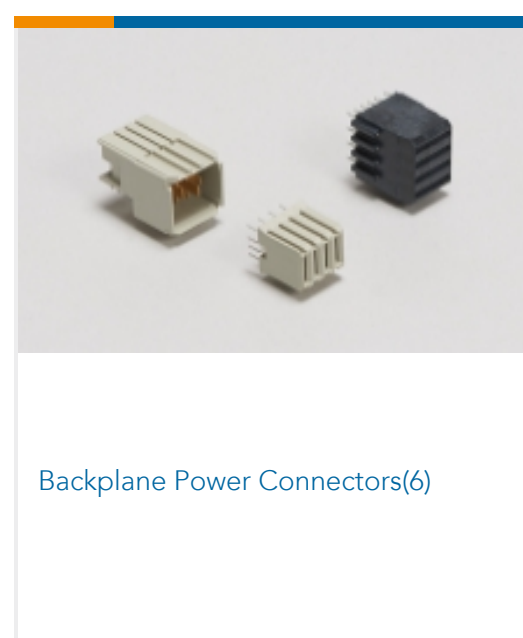
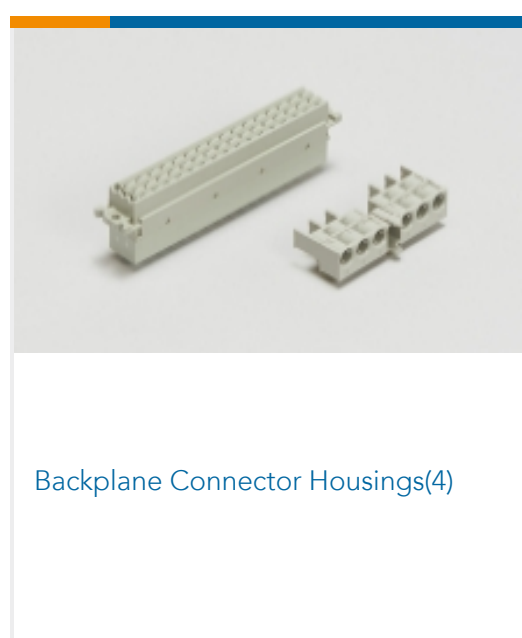



Connector Hardware(97)

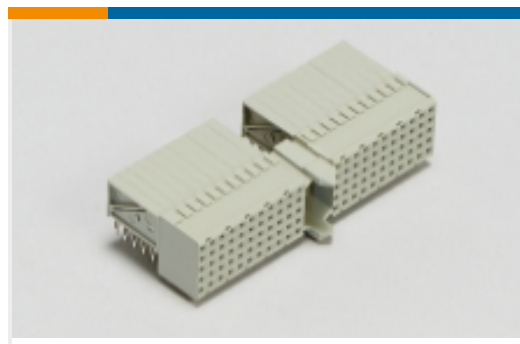

Hard Metric Backplane Connectors (267)

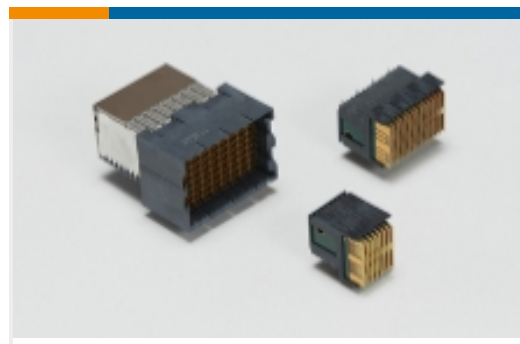

High Speed Backplane Connectors(1)

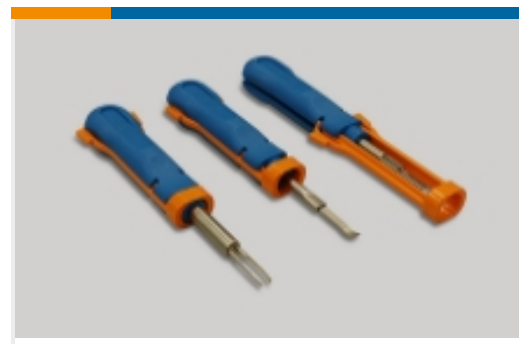

Insertion & Extraction Tools(2)



Rectangular Power Connectors(87)

Customers Also Bought

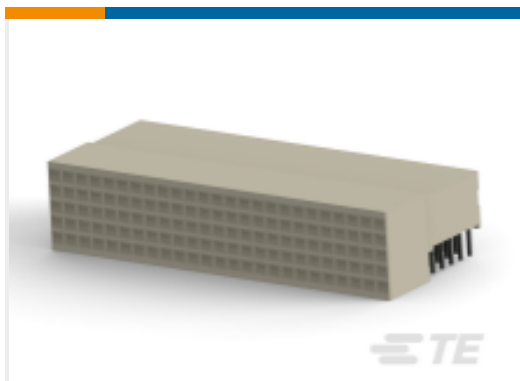

TE Part #5352171-1
HM Receptacle Connector: Traditional Backplane, Coplanar, 2mm

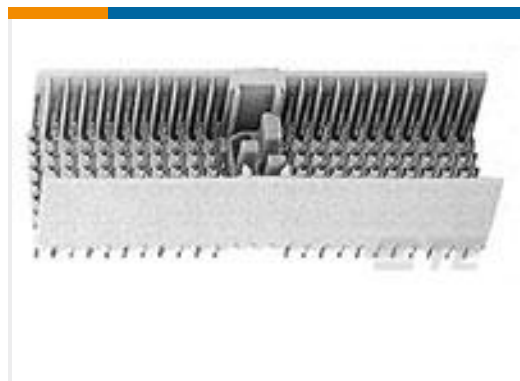

TE Part #5188834-1
Z-PACK/A M-HDR 154P.

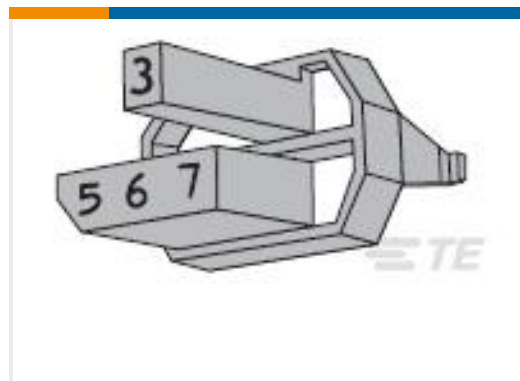

TE Part #3-100526-2
Z-PACK F.CODING KEY

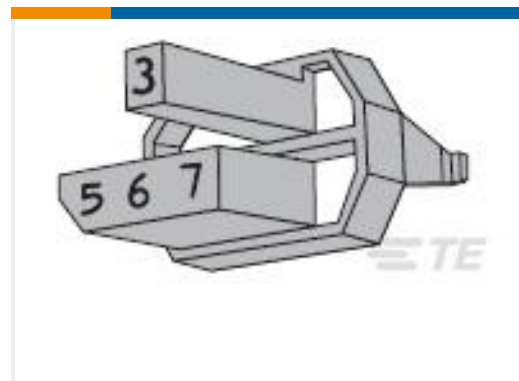

TE Part #5-100526-6
Z-PACK F.CODING KEY

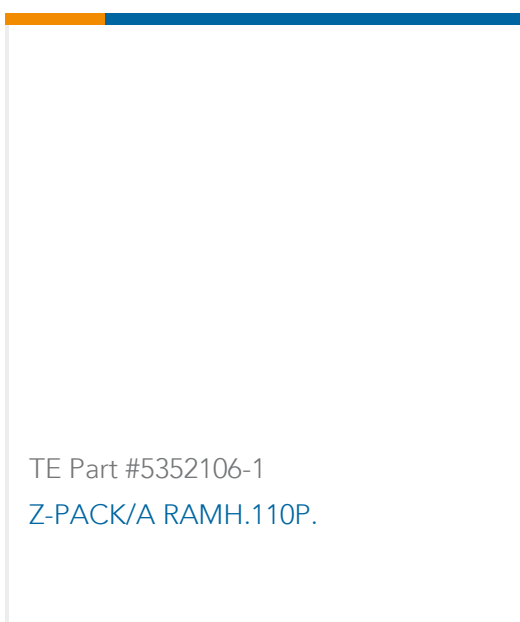

TE Part #5352106-1
Z-PACK/A RAMH.110P.

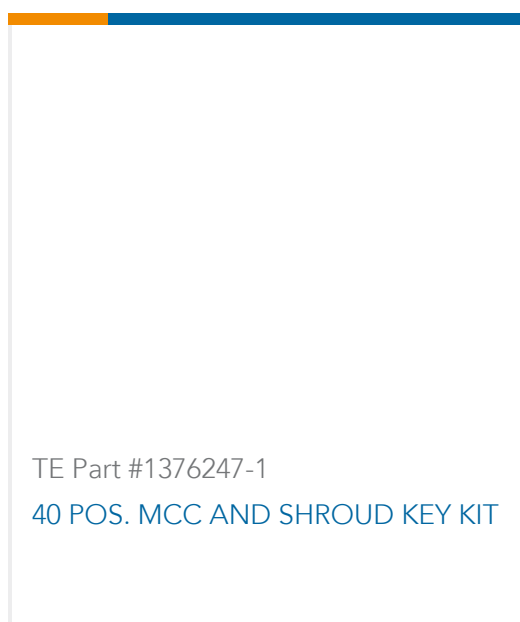

TE Part #1376247-1
40 POS. MCC AND SHROUD KEY KIT

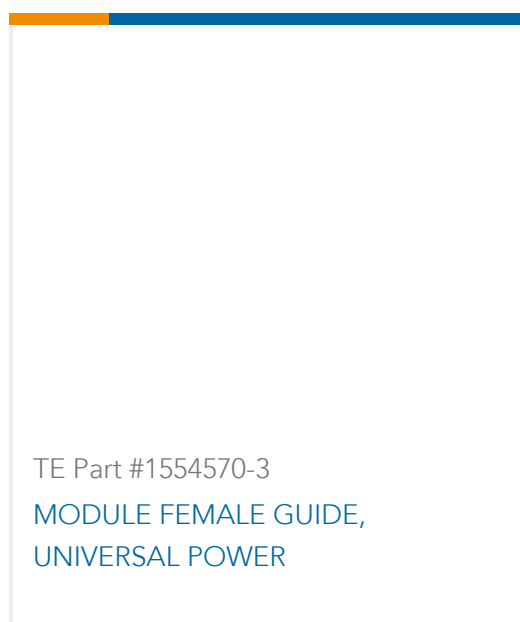

TE Part #1554570-3
MODULE FEMALE GUIDE,
UNIVERSAL POWER

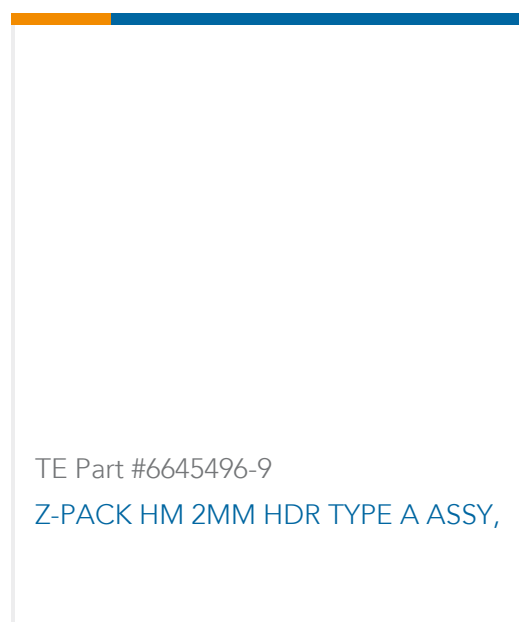

TE Part #6645496-9
Z-PACK HM 2MM HDR TYPE A ASSY,
UNIVERSAL POWER

Documents

Product Drawings

[CODING DEV INSRT COLOR GREEN](#)

English

CAD Files

[3D PDF](#)

[3D](#)

[Customer View Model](#)

[ENG_CVM_CVM_5-100526-4_E.2d_dxf.zip](#)



English

Customer View Model

[ENG_CVM_CVM_5-100526-4_E.3d_igs.zip](#)

English

Customer View Model

[ENG_CVM_CVM_5-100526-4_E.3d_stp.zip](#)

English

By downloading the CAD file I accept and agree to the [Terms and Conditions](#) of use.

Product Specifications

[Application Specification](#)

English