

MicroCon

0.8 mm Connectors

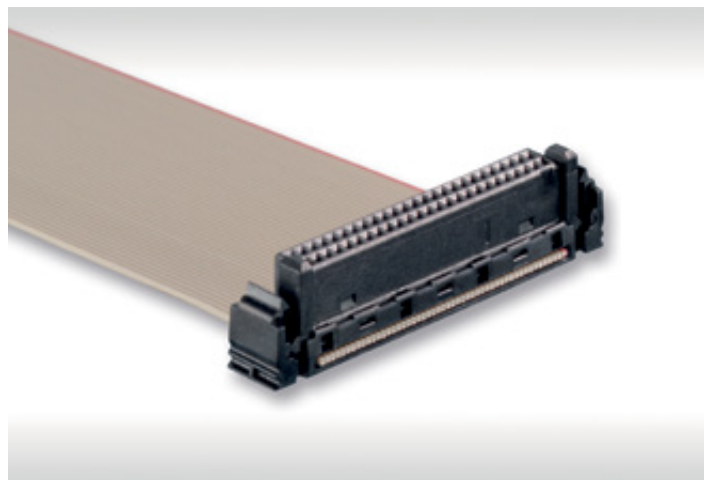
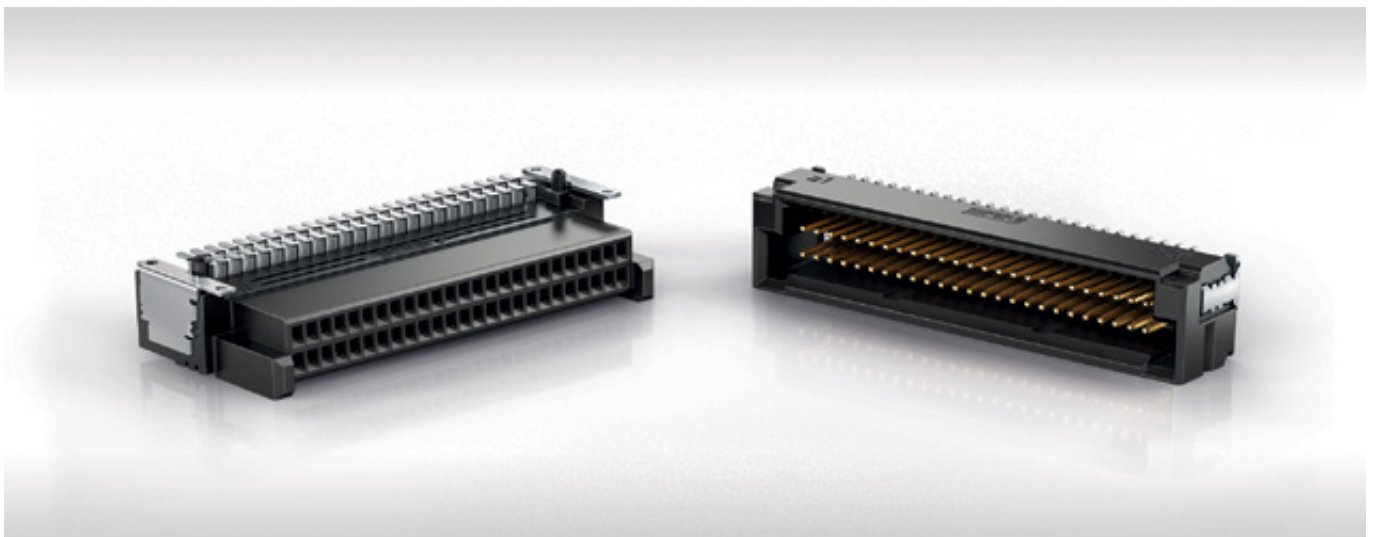

MicroCon DUAL ROW 0.8 MM CONNECTOR

The dual-row MicroCon connector series with 0.8 mm pitch is excellent for various demanding applications in the industrial, medical, lighting, automotive and consumer market. Due to the small dimensions - the 50-pin male connectors show dimensions of only 24.2 mm x 4.7 mm with different heights - robustness was crucial during the development. The male connectors are provided with reinforced sidewalls. More secure mating is provided by coding and blind-mate guide alignments, providing an increased locking range. A special feature for this miniaturized device size is the double-sided spring contact. The reliable and high-quality spring contacts are based on a time-tested principle which has been continuously scaled down for smaller dimensions. Parallel (Mezzanine), right angle (90 °) and coplanar configurations are available to support various PCB applications. With different heights for the male and female connectors, Board-to-Board distances from 5 mm to 19 mm can be realized for Mezzanine applications. Despite the miniaturization, the new connectors offer a high mating tolerance with allowed misalignment tolerances of longitudinal and transverse axes of ± 0.7 mm. The allowed angular inclination tolerance is specified with ± 4 degrees. The male and female connectors are available with Surface Mount Technology (SMT) termination. The robust plastic housing of the female connector resists high temperature and is suitable for lead-free reflow soldering. Tape and reel packaging supports automatic assembly.

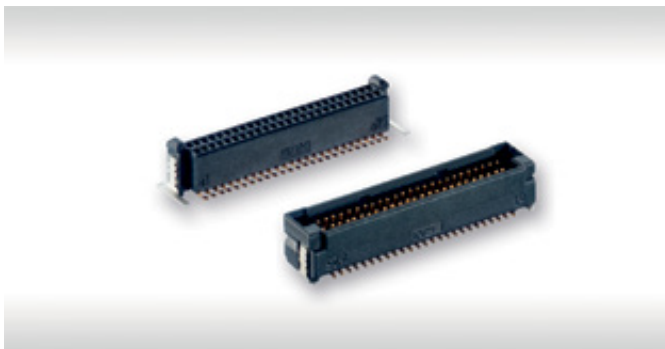

TECHNICAL DETAILS

| | |
|----------------------------|--|
| Pitch | 0.8 mm |
| No. of Pins | 12 - 100 possible |
| Packaging | Tape and reel for automatic assembly |
| Current rating per contact | up to 2.3 A at 20 °C |
| Datarate | up to 3 Gbit/s |
| Termination technology | SMT |
| Variants | Vertical male Right angle male (available 2023) Vertical female Right angle female Cable assemblies (available 2023) |

CAPABILITIES

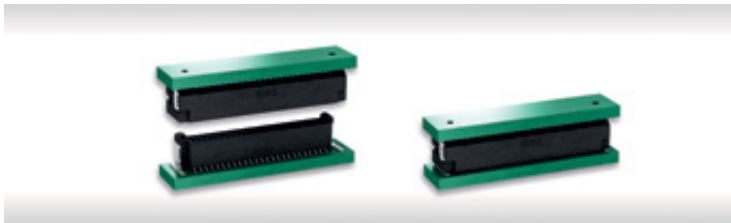

Stacked boards (Mezzanine)

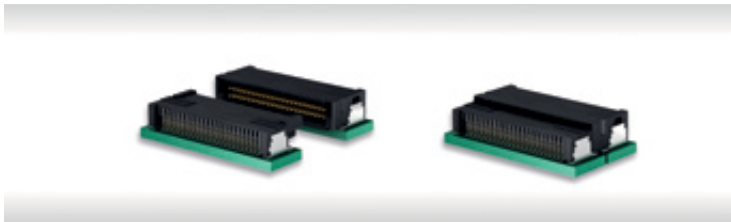

Extender card (coplanar)

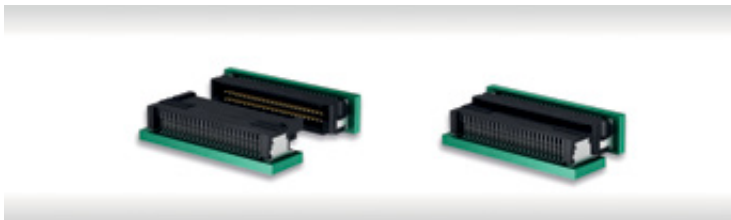

Orthogonal boards

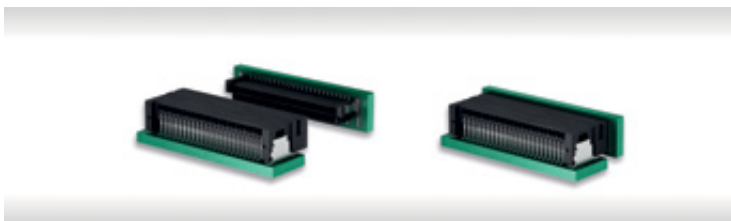

Orthogonal boards



Wire-to-Board (available 2023)

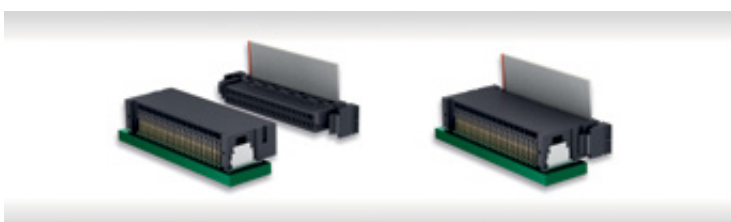

Wire-to-Board (available 2023)

ADVANTAGES

High Reliable Contact Design

- reliable, dual-beam female contact
- rolled, homogeneous surface, provides more secure contact mating
- wide contact surfaces between the mated pairs
- extremely low surface roughness significantly reduces abrasion
- low contact resistance



Polarization / Mating Face

- mating face polarization helps prevent mismating and incorrect connection
- insertion chamfers in the capture range provide more secure mating
- distinctive guide elements for precise insertion



Robust Solder Clips

- outstanding retention forces on the circuit board
- soldering brackets absorb mechanical stress and are able to resist high shock and vibration loads



Lockable Cable Assemblies

- available 2023
- integrated locking lever; can be manually released without tools
- increased protection against accidental release of Wire-to-Board connections
- cable guide provides strain relief

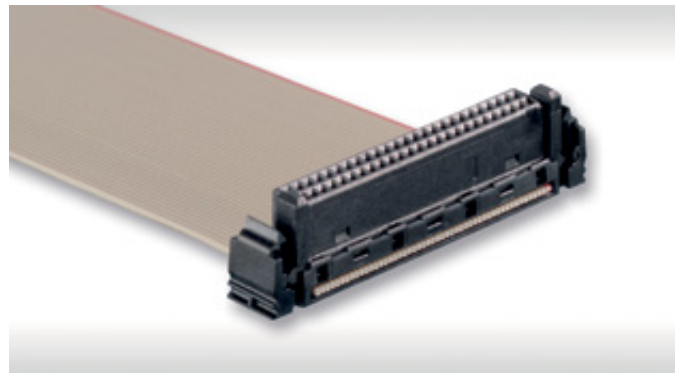

ADVANTAGES

Locating Pegs

- geometrically heterogeneous locating pegs for more precise positioning on the circuit board
- enables excellent compensation of PCB holes for both positive and negative tolerances

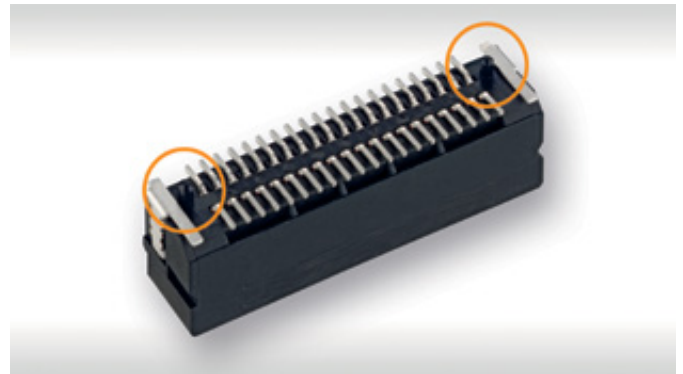

Stacked Boards / Mezzanine

| Board-to-Board Height | Male Connector Stacking Height | Female Connector Stacking Height |
|-----------------------------------|--------------------------------|----------------------------------|
| 5.00 - 6.00 mm | 1 mm | 4 mm |
| 6.00 - 7.00 mm | 2 mm | 4 mm |
| 7.00 - 8.00 mm | 1 mm | 6 mm |
| 8.00 - 9.00 mm | 2 mm | 6 mm |
| 9.00 - 10.00 mm | 1 mm | 8 mm |
| 10.00 - 11.00 mm | 2 mm | 8 mm |
| 13.00 - 14.00 mm (available 2023) | 9 mm (available 2023) | 4 mm |
| 14.00 - 15.00 mm (available 2023) | 10 mm (available 2023) | 4 mm |
| 15.00 - 16.00 mm (available 2023) | 9 mm (available 2023) | 6 mm |
| 16.00 - 17.00 mm (available 2023) | 10 mm (available 2023) | 6 mm |
| 17.00 - 18.00 mm (available 2023) | 9 mm (available 2023) | 8 mm |
| 18.00 - 19.00 mm (available 2023) | 10 mm (available 2023) | 8 mm |

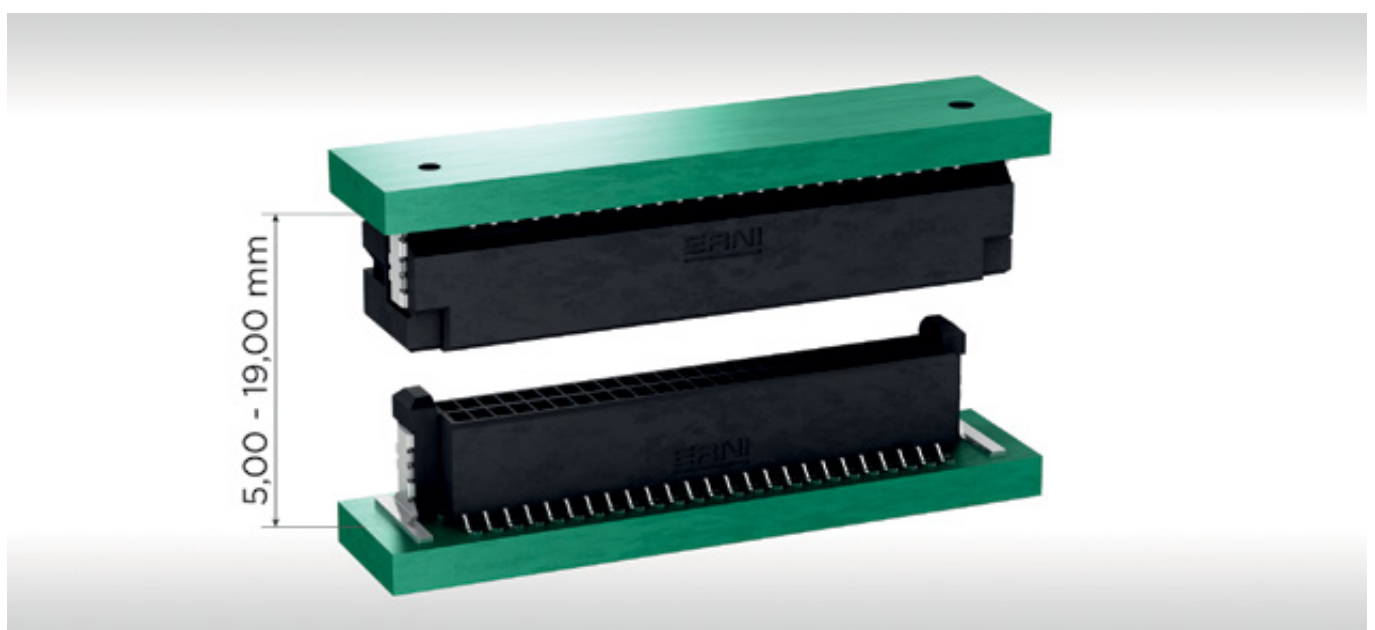

PROCESSING

Tape and Reel Packaging

- transport safe packaging
- automatic assembly



Automatic Assembly and Reflow Soldering

- for efficient processing on modern assembly lines

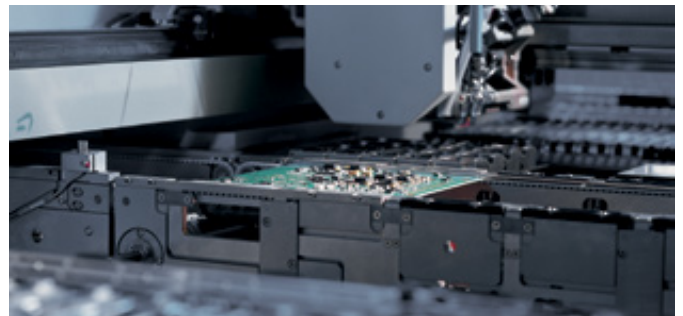

MATING CONDITIONS

Allowed Inclination for a more Secure Self-Centering

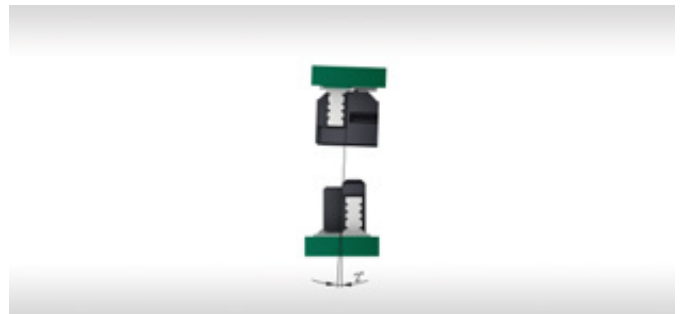
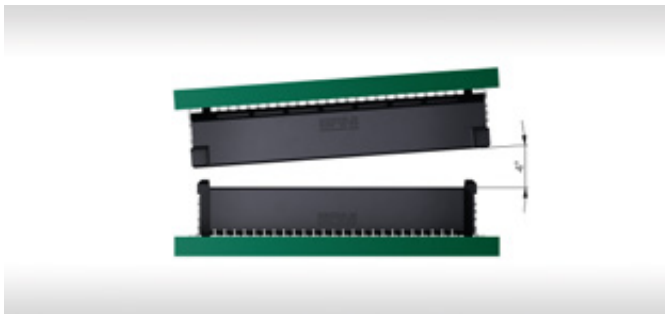

Allowed Misalignment Tolerances for a more Secure Self-Centering

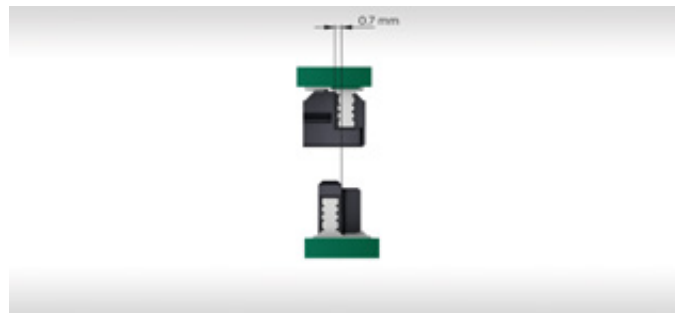
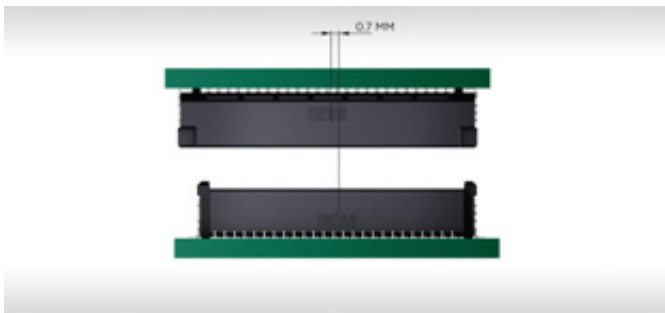

ELECTRICAL AND MECHANICAL CHARACTERISTICS

Technical Data

| Description | Standard | Female, Vertical and Right Angle | |
|---|-----------------------|--|----------------|
| | | Male, Right Angle | Male, Vertical |
| Climate category | DIN EN 60068-1 test b | 55 / 125 / 56 | |
| Operating temperature | | -55 / 125 °C | |
| Storage conditions * (see page 13) | IEC 60721-3-1 | - | 1K6 |
| | JDEC-J-STD-020 | information will follow | - |
| Current rating per contact | IEC60512-5-2 Test 5b | 16 pin Version 2.82 A at 20 °C 50 pin Version 2.10 A at 20 °C 100 pin Version 1.47 A at 20 °C | |
| Air- and creepage distance | | 0.25 mm | |
| Operating voltage | IEC 60664 | The permissible operating voltages depend on the customer application and on the applicable or specified safety requirements. Insulation coordination according to IEC 60664-1 has to be regarded for the complete electrical device. Therefore, the maximum creepage and clearance distances of the mated connectors are specified for consideration as a part of the whole current path. In practice, reductions in creepage or clearance distances may occur due to the conductive pattern of the printed board or the wiring used, and have to be taken into account separately. As a result the creepage and clearance distances for the application may be reduced compared to those of the connector. | |
| Dielectric strength | IEC 60512 test 4a | contact - contact 500 V _{rms} | |
| Contact resistance | IEC 60512 test 2a | < 35 mΩ | |
| Insulation resistance | IEC 60512 test 3a | > 100 MΩ | |
| Vibration, sine | IEC 60512 test 6d | 10 - 2000 Hz 20 g | |
| Contact disturbance (while vibration test) | IEC 60512 test 2e | < 1 μs | |
| Shock halfsine | IEC 60512 test 6c | 50 g 11 ms | |
| Contact disturbance (while shock test) | IEC 60512 test 2e | < 1 μs | |
| Mechanical operation | IEC 60512 test 9a | > 500 mating cycles | |
| Insertion and withdrawal force | IEC 60512 test 13b | typical value 0.5 N per contact | |
| Processing Conditions | | | |
| Reflow soldering temperature max. | JEDEC J-STD-020 | 20 - 40 s at 260 °C | |
| Coplanarity | | < 0.1 mm | |

ELECTRICAL AND MECHANICAL CHARACTERISTICS

Technical Data

| Description | Standard | Female, Vertical and Right Angle | |
|--------------------------|-----------|----------------------------------|----------------|
| | | Male, Right Angle | Male, Vertical |
| Housing Material | | | |
| Insulation body | | PPA | LCP |
| CTI value | IEC 60112 | 600 | 175 |
| UL flame rating | | UL 94 V-0 | |
| UL file plastic material | | E90350 | E83005 |
| Contact Material | | | |
| Base material | | Cu alloy | |
| Mating area | | gold plating | |
| Termination area | | Sn | |
| Clip Material | | | |
| Base material | | Cu alloy | |
| Plating | | Sn | |

ELECTRICAL AND MECHANICAL CABLE CHARACTERISTICS

Technical Data Flat Ribbon Cables (available 2023)

| Description | Standard cable (PVC) |
|-----------------------|--|
| Cross section | AWG-34 / 0.02 mm ² |
| Conductor | solid Cu wire, tinned, 0.02 mm ² |
| Coded wire | available |
| Insulation | PVC gray (similar to RAL 7032) |
| Insulation thickness | min. 0.08 mm |
| Shore hardness | 94 ±3 (Shore A) |
| Bending radius | single: 7.5 x thickness multiple: 25 x thickness |
| Technical Data | |
| Temperature range | -30/105 °C (fixed) -10/105 °C (mobile) |
| Dielectric strength | 500 V _{rms} |
| Conductor resistance | ≤ 980 Ω/km at 20 °C |
| Insulation resistance | ≥ 20 MΩ x km at 20 °C |
| Impedance | 130 Ω (wire-wire) 80 Ω (Ground-Signal-Ground) |
| RoHS | compliant |
| Flame rating | UL 1581 Sec. 1090 (Horizontal Flame Test) IEC 60332-2-2 |

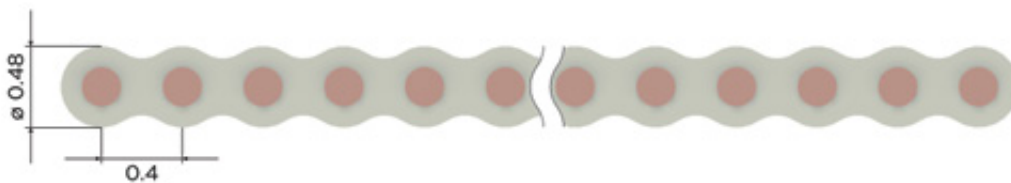

RIGHT ANGLE FEMALE

Product Specification

- SMT termination
- 2 - 100 pins possible
- tape and reel packaging for automatic assembly
- blind mate guide alignment for more secure mating
- for available part numbers please refer to our website



Dimensional Drawings

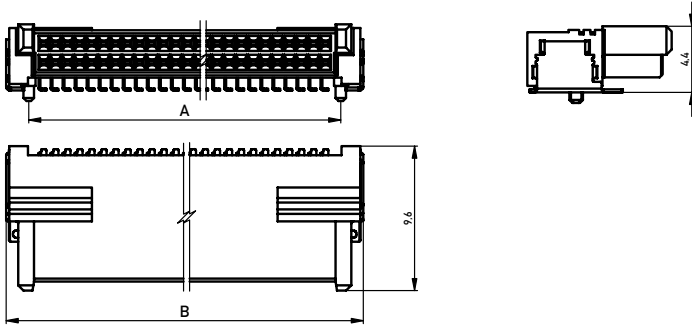

| No. of Contacts | A | B |
|-----------------|-------|-------|
| 12 | 6.00 | 9.00 |
| 16 | 7.60 | 10.60 |
| 26 | 11.60 | 14.60 |
| 32 | 14.00 | 17.00 |
| 40 | 17.20 | 20.20 |
| 50 | 21.20 | 24.20 |
| 68 | 28.40 | 31.40 |
| 80 | 33.40 | 36.20 |
| 100 | 41.20 | 44.20 |

All dimensions in mm

Recommended Layout

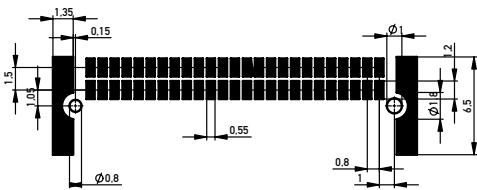

RIGHT ANGLE MALE

Product Specification

- SMT termination
- 2 - 100 pins possible
- tape and reel packaging for automatic assembly
- blind mate guide alignment for more secure mating
- for available part numbers please refer to our website



Dimensional Drawings

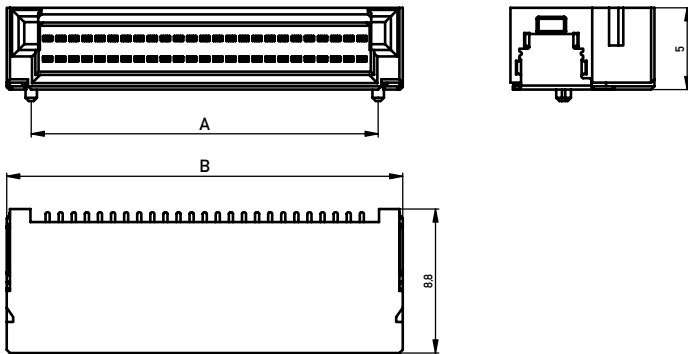

| No. of Contacts | A | B |
|-----------------|-------|-------|
| 12 | 6.00 | 9.00 |
| 16 | 7.60 | 10.60 |
| 26 | 11.60 | 14.60 |
| 32 | 14.00 | 17.00 |
| 40 | 17.20 | 20.20 |
| 50 | 21.20 | 24.20 |
| 68 | 28.40 | 31.40 |
| 80 | 33.40 | 36.20 |
| 100 | 41.20 | 44.20 |

All dimensions in mm

Recommended Layout

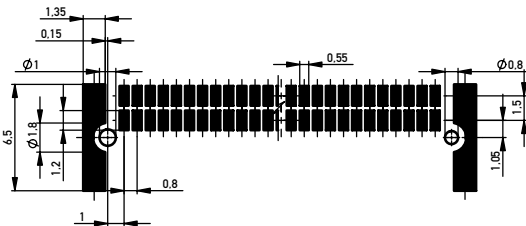

VERTICAL FEMALE

Product Specification

- SMT Termination
- 2 - 100 pins possible
- various heights up to 8 mm possible
- tape and reel packaging for automatic assembly
- blind mate guide alignment for more secure mating
- for available part numbers please refer to our website

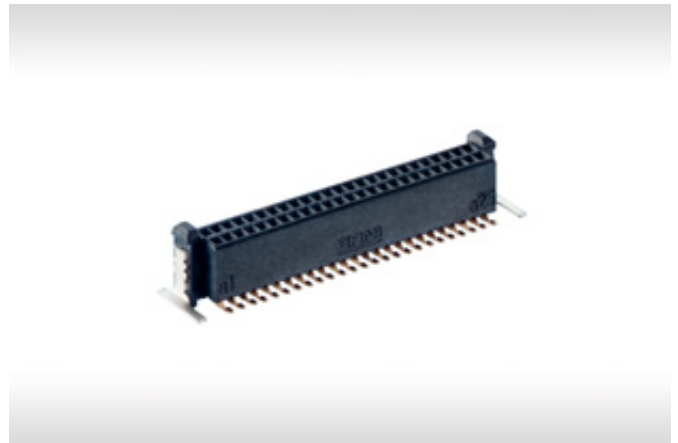

Dimensional Drawings

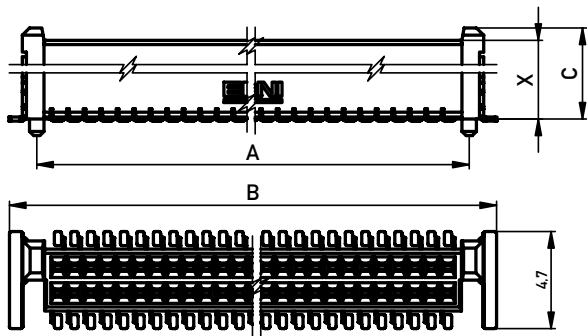

| No. of Contacts | A | B |
|-----------------|-------|-------|
| 12 | 6.00 | 8.70 |
| 16 | 7.60 | 10.30 |
| 26 | 11.60 | 14.30 |
| 32 | 14.00 | 16.70 |
| 40 | 17.20 | 19.90 |
| 50 | 21.20 | 23.90 |
| 68 | 28.40 | 31.10 |
| 80 | 33.20 | 35.90 |
| 100 | 41.20 | 43.90 |

| Stacking height X | C |
|-------------------|------|
| 4 | 4.60 |
| 6 | 6.60 |
| 8 | 8.60 |

All dimensions in mm

Recommended Layout

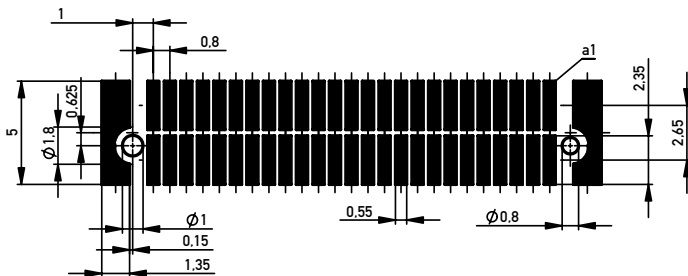

VERTICAL MALE

Product Specification

- SMT Termination
- 2 - 100 pins possible
- various heights up to 2mm (10 mm available 2023) possible
- tape and reel packaging for automatic assembly
- blind mate guide alignment for more secure mating
- for available part numbers please refer to our website



Dimensional Drawings

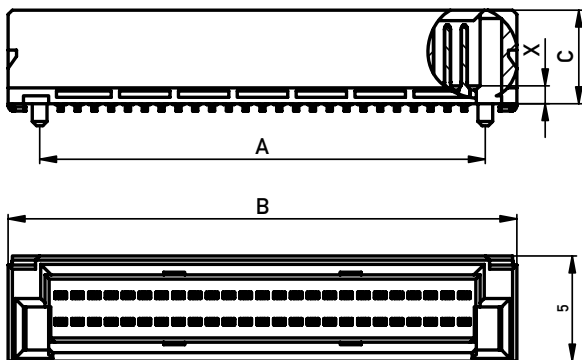

| No. of Contacts | A | B |
|-----------------|-------|-------|
| 12 | 6.00 | 9.00 |
| 16 | 7.60 | 10.60 |
| 26 | 11.60 | 14.60 |
| 32 | 14.00 | 17.00 |
| 40 | 17.20 | 19.20 |
| 50 | 21.20 | 24.20 |
| 68 | 28.40 | 31.40 |
| 80 | 33.20 | 36.20 |
| 100 | 41.20 | 44.20 |

| Stacking height X | C |
|-------------------|------|
| 1 | 4.80 |
| 2 | 5.80 |

All dimensions in mm

Recommended Layout

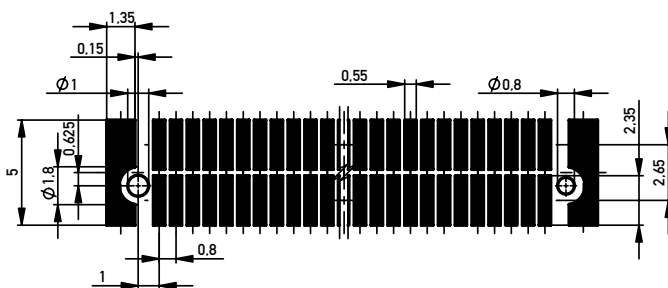

CABLE ASSEMBLIES

Product Specification

- available 2023
- IDC termination
- 2 - 68 pins possible
- various cable lengths possible
- ribbon cable AWG 34
- 90° cable outlet
- blind mate guide alignment for more secure mating

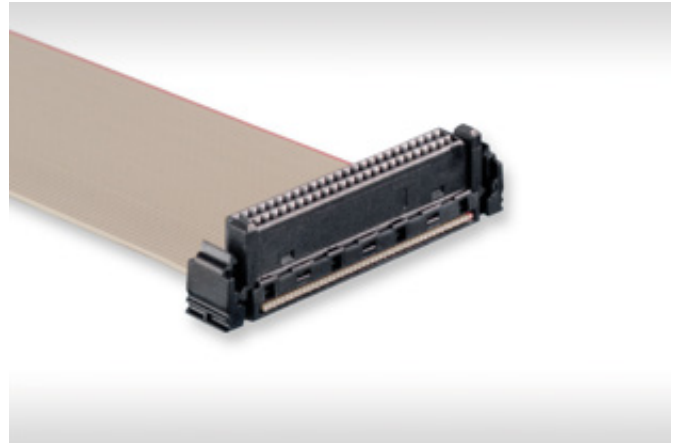

Dimensional Drawings 50 pin version

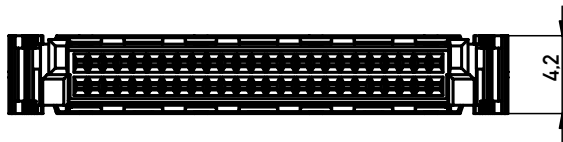
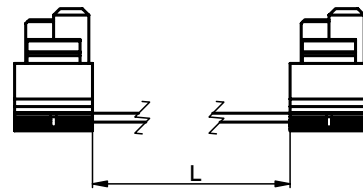
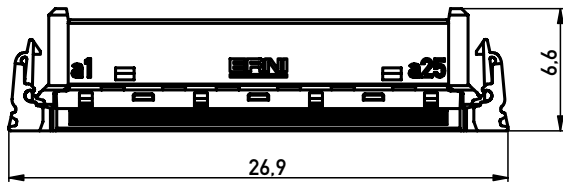

ADDITIONAL INFORMATION ON STORAGE CONDITIONS

Moisture Sensitivity Level (MSL) relates to the packaging and handling precautions for plastic encapsulated surface mount packages and other packages made with moisture-permeable materials. The MSL is an electronic industry rating that describes how long a potentially moisture sensitive device can be exposed to ambient temperature and humidity conditions (e.g. 30°C and 60% Relative Humidity) prior to being soldered in place. Semiconductor devices absorb moisture and may be damaged during surface mount reflow, when moisture trapped inside the component expands. The expansion of trapped moisture can result in internal cracks or delamination of the plastic. In the most severe case, the component will bulge and pop. This is also known as the so-called „popcorn“ effect.

The parameters for testing of the moisture sensitivity and for the storage and handling of such nonhermetic surface mount devices are defined in the JEDEC J-STD-020 standard.

In general, connectors are different from semiconductor devices, however they undergo the same soldering process and hence need to resist the same temperature requirements. Therefore, ERNI tests the connector devices according to the same MSL test parameters defined for nonhermetic surface mount devices in JEDEC J-STD-020.

To prove the applicability of shelf life conditions and support later solder processability, these MSL tests are accelerated in time by applying higher temperature and humidity. The subsequent exposure to solder heat in the test procedure is performed with higher temperatures than those allowed as the maximum temperature for the actual soldering process.

Usually, plastics materials show moisture absorption parameters with non-negligible dependency of the storage temperature. This circumstance makes modern connector materials like high performance Polyphthalamide (PPA) even more sensitive to moisture absorption under high test-temperature influence. The moisture “soak conditions” in the test procedure is 85°C, whereas the storage temperature is limited to 30°C. In consequence, samples may fail in these MSL tests, although their storage and solder process properties perfectly fit those present in state-of-the-art electronics manufacturing.

The classification of groups of environmental storage conditions from 1k1 to 1k11 is defined in the IEC 60721-3-1 standard. In JEDEC J-STD-020, the floor life conditions are limited to only two groups, either 30°C/85%RH or 30°C/60%RH with respective floor life times of the components. Unfortunately, no exact relation exists between the assumed storage conditions between JEDEC J-STD-020 and IEC 60721-3-1. Under the general assumption that no bedewing of water on the surface of electronic devices during storage takes place, ERNI connectors with PPA plastics material can be stored in those storage conditions with 30°C/60%RH given in the JEDEC J-STD-020 standard without any additional drying or “baking” needs. Hence, although the ERNI connectors with high performance PPA plastics material did not pass the harsh MSL1 test conditions, under normal storage conditions there is no need to pack them in Moisture Barrier Bags (MBB). In consequence, the ERNI connectors can be stored under 30°C/60%RH conditions without drying or MBB packing needs.

Connect With Us

We make it easy to connect with our experts and are ready to provide the support you need. Visit www.te.com/support to chat with a Product Information Specialist.

te.com

2023 TE Connectivity. All Rights Reserved.

TE Connectivity, TE connectivity (logo) ERNI, MicroCon and Every Connection Counts are trademarks owned or licensed by the TE Connectivity family of companies. All other logos, products and/or company names referred to herein might be trademarks of their respective owners.

The information given herein, including drawings, illustrations and schematics which are intended for illustration purposes only, is believed to be reliable. However, TE Connectivity makes no warranties as to its accuracy or completeness and disclaims any liability in connection with its use. TE Connectivity's obligations shall only be as set forth in TE Connectivity's Standard Terms and Conditions of Sale for this product and in no case will TE Connectivity be liable for any incidental, indirect or consequential damages arising out of the sale, resale, use or misuse of the product. Users of TE Connectivity products should make their own evaluation to determine the suitability of each such product for the specific application.

JS 10/23 Original

CATALOG

TE Connectivity

ERNI Deutschland GmbH
a TE Connectivity Ltd. company
Seestraße 9
73099 Adelberg
Germany

Tel +49 7166 50-0
www.te.com