

## EPC2040 – Enhancement Mode Power Transistor

$V_{DS}, 15\text{ V}$

$R_{DS(on)}, 30\text{ m}\Omega$

$I_D, 3.4\text{ A}$

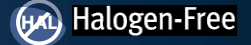

Gallium Nitride's exceptionally high electron mobility and low temperature coefficient allows very low  $R_{DS(on)}$ , while its lateral device structure and majority carrier diode provide exceptionally low  $Q_G$  and zero  $Q_{RR}$ . The end result is a device that can handle tasks where very high switching frequency, and low on-time are beneficial as well as those where on-state losses dominate.

## Maximum Ratings

PARAMETER		VALUE	UNIT
$V_{DS}$	Drain-to-Source Voltage (Continuous)	15	V
	Drain-to-Source Voltage (up to 10,000 5 ms pulses at 150°C)	18	
$I_D$	Continuous ( $T_A = 25^\circ\text{C}$ , $R_{\theta JA} = 220^\circ\text{C/W}$ )	3.4	A
	Pulsed ( $25^\circ\text{C}$ , $T_{PULSE} = 300\ \mu\text{s}$ )	28	
$V_{GS}$	Gate-to-Source Voltage	6	V
	Gate-to-Source Voltage	-4	
$T_J$	Operating Temperature	-40 to 150	$^\circ\text{C}$
$T_{STG}$	Storage Temperature	-40 to 150	

## Thermal Characteristics

PARAMETER		TYP	UNIT
$R_{\theta JC}$	Thermal Resistance, Junction-to-Case	5.7	$^\circ\text{C/W}$
$R_{\theta JB}$	Thermal Resistance, Junction-to-Board	39	
$R_{\theta JA}$	Thermal Resistance, Junction-to-Ambient (Note 1)	97	

Note 1:  $R_{\theta JA}$  is determined with the device mounted on one square inch of copper pad, single layer 2 oz copper on FR4 board. See [https://epc-co.com/epc/documents/product-training/Appnote\\_Thermal\\_Performance\\_of\\_eGaN\\_FETs.pdf](https://epc-co.com/epc/documents/product-training/Appnote_Thermal_Performance_of_eGaN_FETs.pdf) for details

Static Characteristics ( $T_J = 25^\circ\text{C}$  unless otherwise stated)

PARAMETER		TEST CONDITIONS	MIN	TYP	MAX	UNIT
$BV_{DSS}$	Drain-to-Source Voltage	$V_{GS} = 0\text{ V}$ , $I_D = 300\ \mu\text{A}$	15			V
$I_{DSS}$	Drain-Source Leakage	$V_{DS} = 12\text{ V}$ , $V_{GS} = 0\text{ V}$		10	250	$\mu\text{A}$
$I_{GSS}$	Gate-to-Source Forward Leakage	$V_{GS} = 5\text{ V}$		0.1	1.2	mA
	Gate-to-Source Reverse Leakage	$V_{GS} = -4\text{ V}$		10	250	$\mu\text{A}$
$V_{GS(TH)}$	Gate Threshold Voltage	$V_{DS} = V_{GS}$ , $I_D = 1\text{ mA}$	0.8	1.4	2.5	V
$R_{DS(on)}$	Drain-Source On Resistance	$V_{GS} = 5\text{ V}$ , $I_D = 1.5\text{ A}$		24	30	m $\Omega$
$V_{SD}$	Source-Drain Forward Voltage	$I_S = 0.5\text{ A}$ , $V_{GS} = 0\text{ V}$		2.2		V

All measurements were done with substrate connected to source.

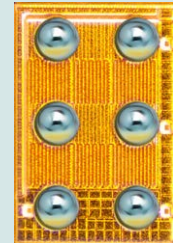

EPC2040 eGaN® FETs are supplied only in passivated die form with solder bumps  
Die Size: 0.85 mm x 1.2 mm

## Applications

- High Speed DC-DC conversion
- Lidar/Pulsed Power Applications
- Lidar for Augmented Reality Applications

## Benefits

- Ultra High Efficiency
- Ultra Low  $R_{DS(on)}$
- Ultra Low  $Q_G$
- Ultra Small Footprint

Dynamic Characteristics ( $T_J=25^\circ\text{C}$  unless otherwise stated)

PARAMETER		TEST CONDITIONS	MIN	TYP	MAX	UNIT	
$C_{ISS}$	Input Capacitance	$V_{DS} = 6\text{ V}, V_{GS} = 0\text{ V}$		86	105	pF	
$C_{RSS}$	Reverse Transfer Capacitance			20			
$C_{OSS}$	Output Capacitance			67	100		
$C_{OSS(ER)}$	Effective Output Capacitance, Energy Related (Note 2)	$V_{DS} = 0\text{ to }6\text{ V}, V_{GS} = 0\text{ V}$		106			
$C_{OSS(TR)}$	Effective Output Capacitance, Time Related (Note 3)			87			
$R_G$	Gate Resistance			0.5		$\Omega$	
$Q_G$	Total Gate Charge	$V_{DS} = 6\text{ V}, V_{GS} = 5\text{ V}, I_D = 1.5\text{ A}$		745	925	pC	
$Q_{GS}$	Gate-to-Source Charge			230			
$Q_{GD}$	Gate-to-Drain Charge		$V_{DS} = 6\text{ V}, I_D = 1.5\text{ A}$		140		
$Q_{G(TH)}$	Gate Charge at Threshold				165		
$Q_{OSS}$	Output Charge	$V_{DS} = 6\text{ V}, V_{GS} = 0\text{ V}$		420	630		
$Q_{RR}$	Source-Drain Recovery Charge			0			

Note 2:  $C_{OSS(ER)}$  is a fixed capacitance that gives the same stored energy as  $C_{OSS}$  while  $V_{DS}$  is rising from 0 to 40%  $BV_{DSS}$ .

Note 3:  $C_{OSS(TR)}$  is a fixed capacitance that gives the same charging time as  $C_{OSS}$  while  $V_{DS}$  is rising from 0 to 40%  $BV_{DSS}$ .

Figure 1: Typical Output Characteristics at 25°C

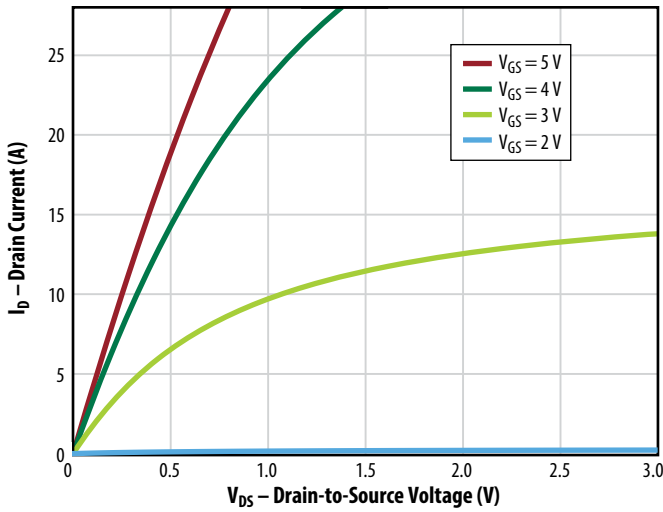

Figure 2: Transfer Characteristics

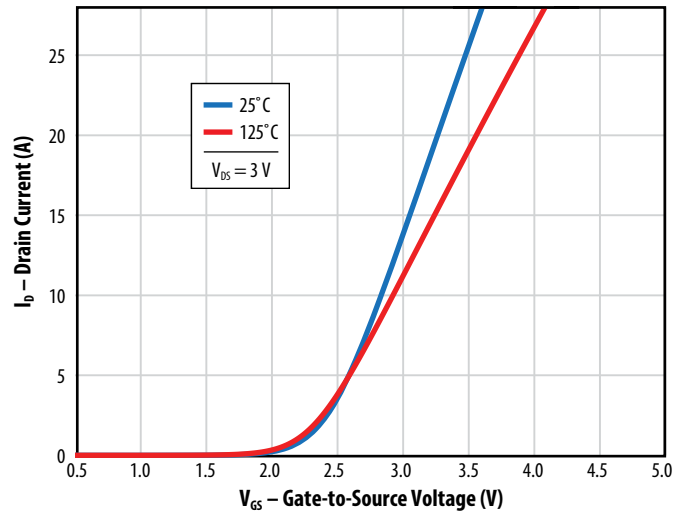

Figure 3:  $R_{DS(on)}$  vs.  $V_{GS}$  for Various Drain Currents

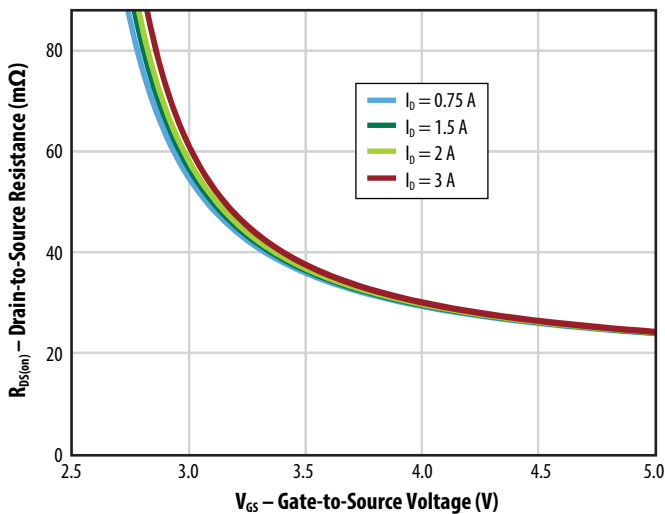

Figure 4:  $R_{DS(on)}$  vs.  $V_{GS}$  for Various Temperatures

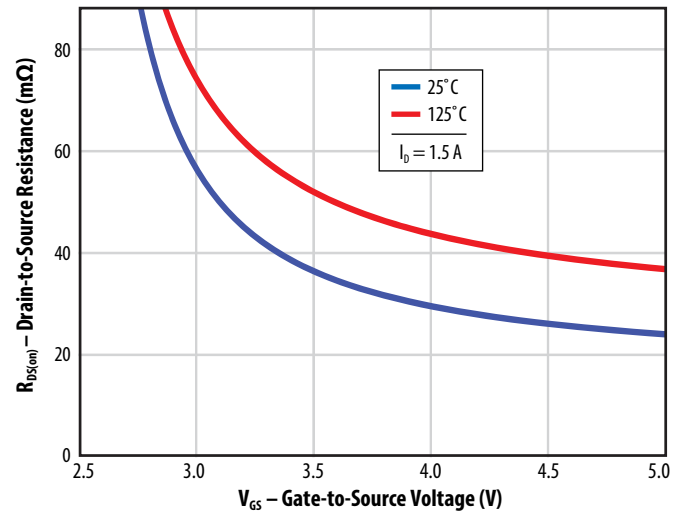

Figure 5a: Capacitance (Linear Scale)

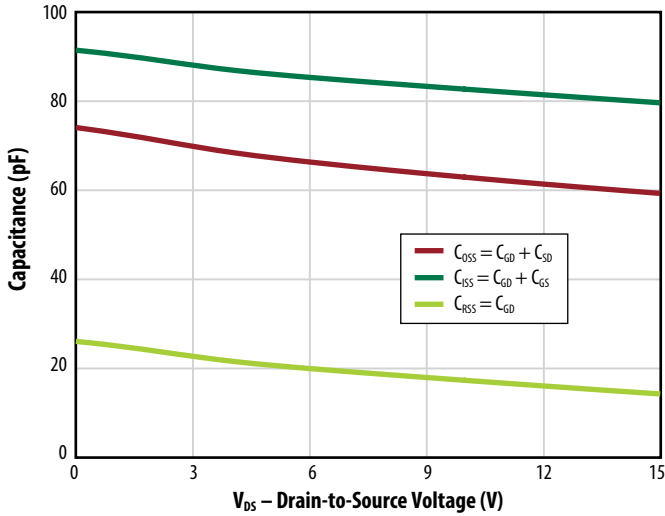

Figure 5b: Capacitance (Log Scale)

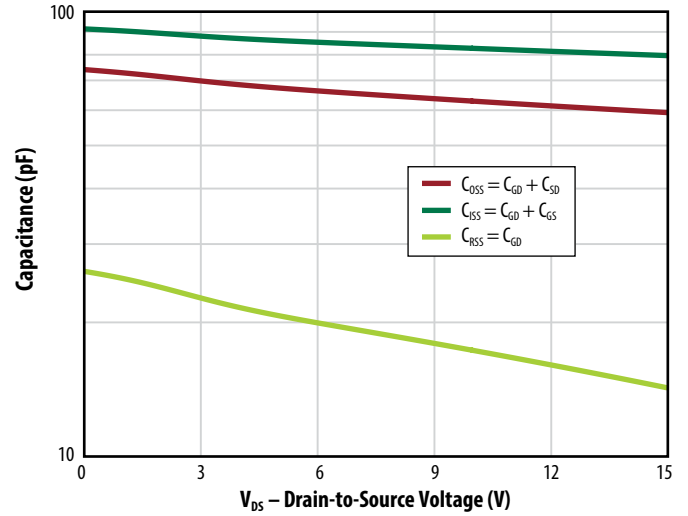

Figure 6: Gate Charge

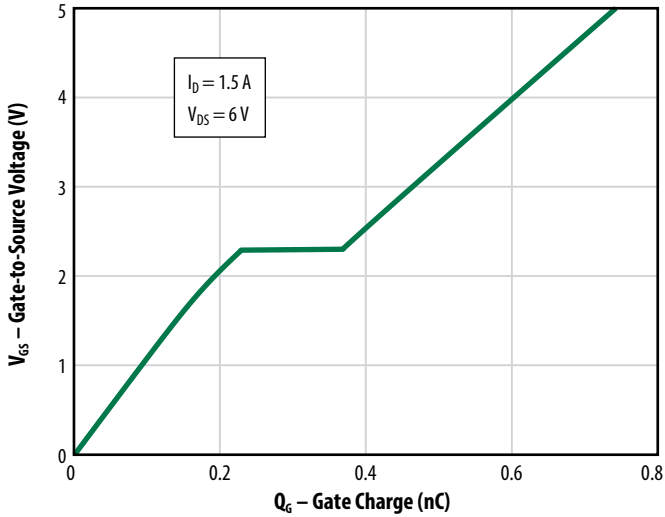

Figure 7: Reverse Drain-Source Characteristics

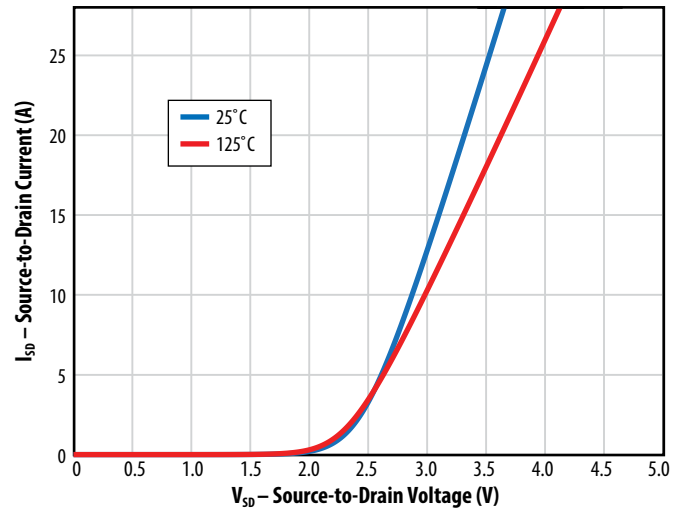

Figure 8: Normalized On-State Resistance vs. Temperature

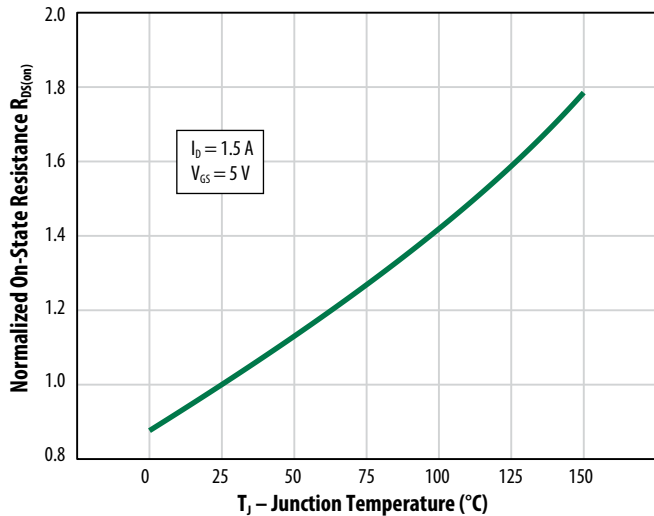
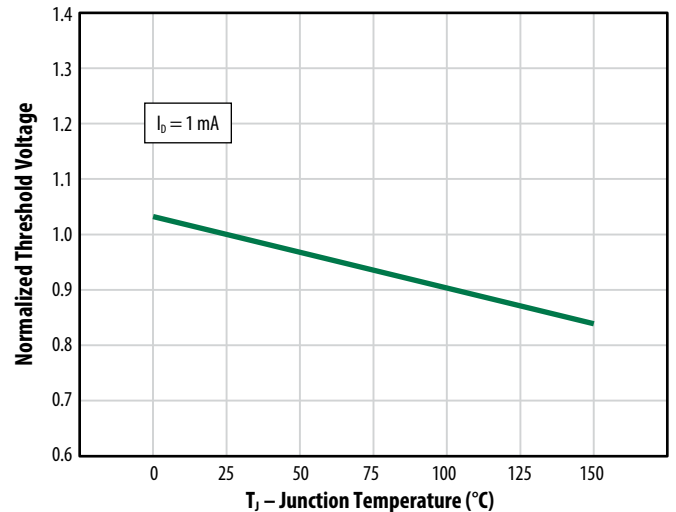

Figure 9: Normalized Threshold Voltage vs. Temperature



All measurements were done with substrate shorted to source.

Figure 10: Safe Operating Area

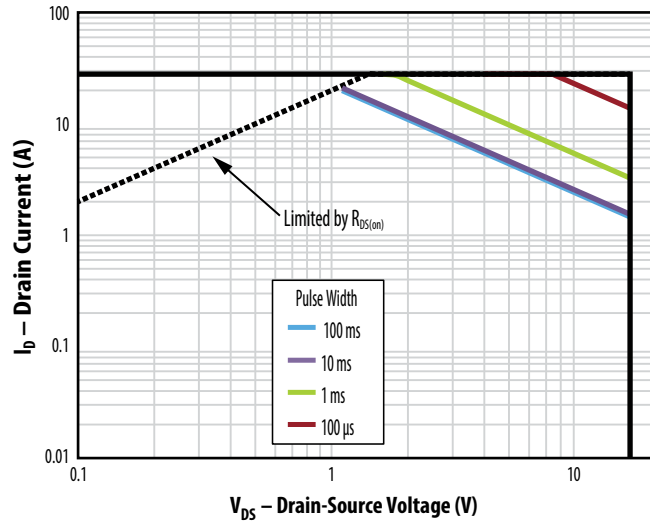
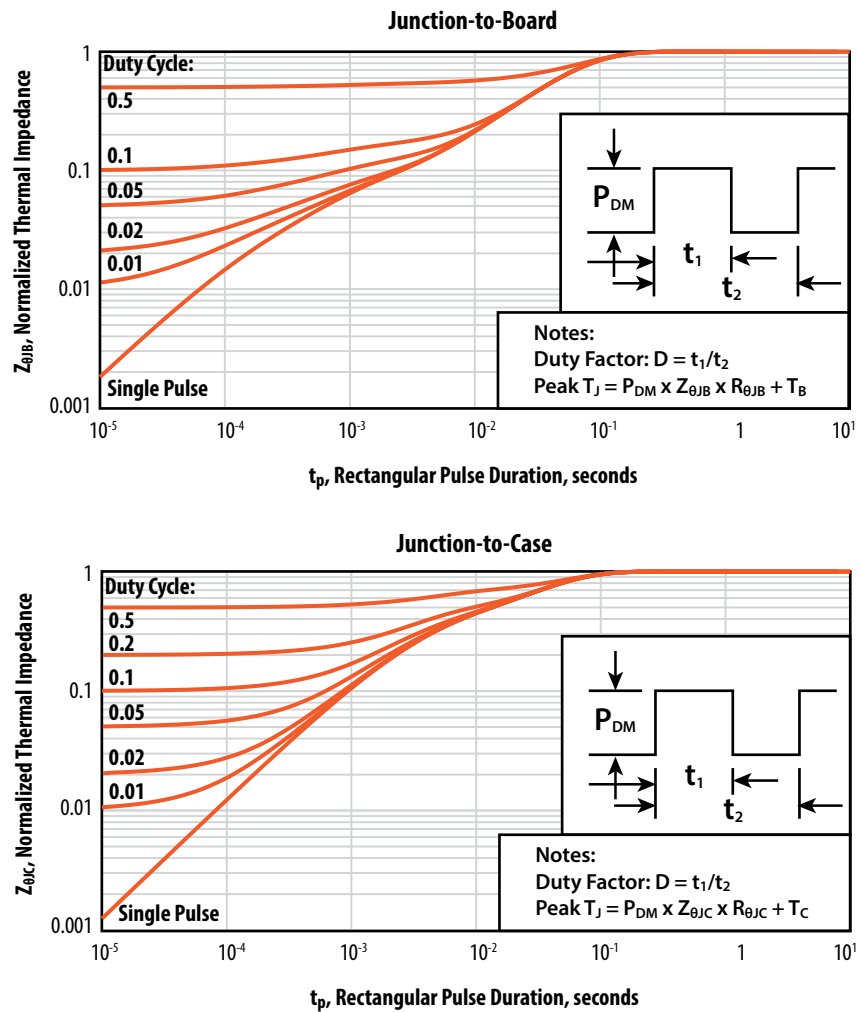
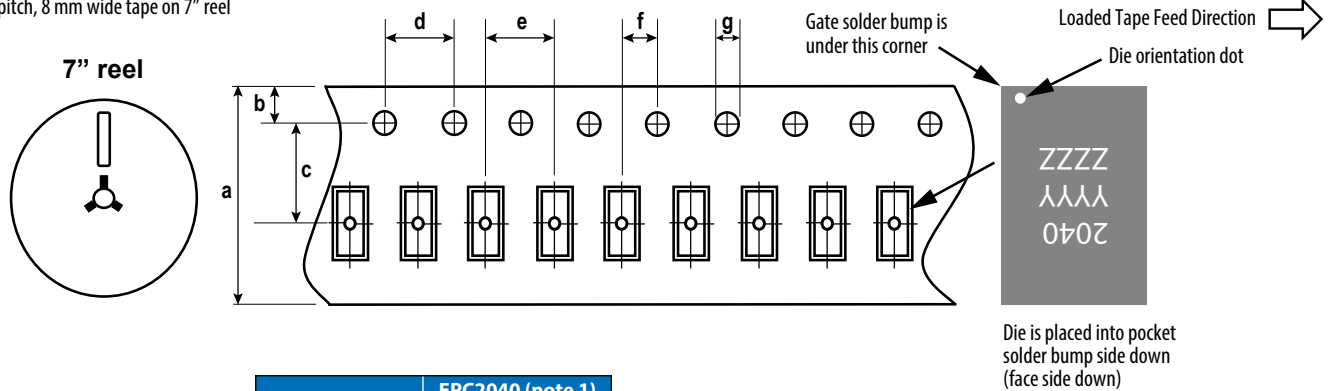

Figure 11: Transient Thermal Response Curves



**TAPE AND REEL CONFIGURATION**

4 mm pitch, 8 mm wide tape on 7" reel



Dimension (mm)	EPC2040 (note 1)		
	target	min	max
a	8.00	7.90	8.30
b	1.75	1.65	1.85
c (note 2)	3.50	3.45	3.55
d	4.00	3.90	4.10
e	4.00	3.90	4.10
f (note 2)	2.00	1.95	2.05
g	1.5	1.5	1.6

Note 1: MSL 1 (moisture sensitivity level 1) classified according to IPC/JEDEC industry standard.  
 Note 2: Pocket position is relative to the sprocket hole measured as true position of the pocket, not the pocket hole.

**DIE MARKINGS**

Part Number	Laser Markings		
	Part # Marking Line 1	Lot_Date Code Marking line 2	Lot_Date Code Marking line 3
EPC2040	2040	YYYY	ZZZZ

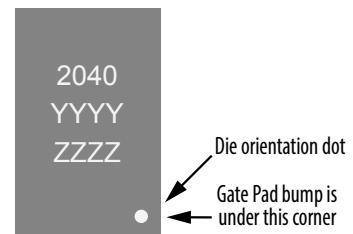

**DIE OUTLINE**  
Solder Bump View

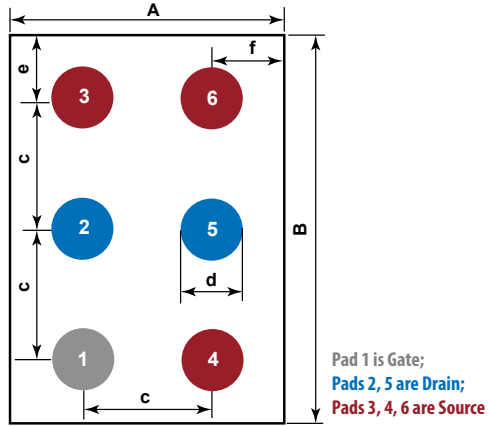

DIM	Micrometers		
	MIN	Nominal	MAX
A	820	850	880
B	1170	1200	1230
c		400	
d	187	208	229
e	185	200	215
f	210	225	240

Side View

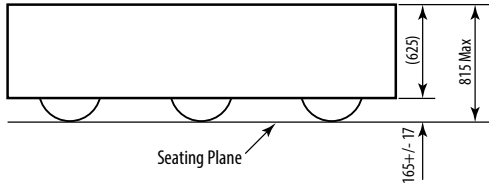

**RECOMMENDED LAND PATTERN**  
(measurements in  $\mu\text{m}$ )

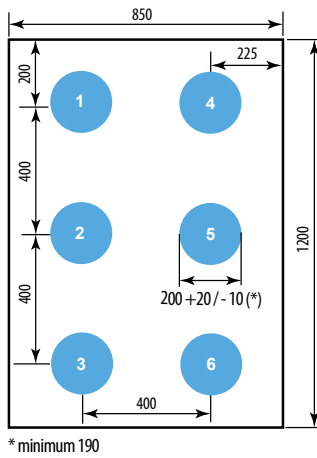

The land pattern is solder mask defined  
Solder mask is 10  $\mu\text{m}$  smaller per side than bump

Pad 1 is Gate;  
Pads 2, 5 are Drain;  
Pads 3, 4, 6 are Source

**RECOMMENDED STENCIL DRAWING**  
(measurements in  $\mu\text{m}$ )

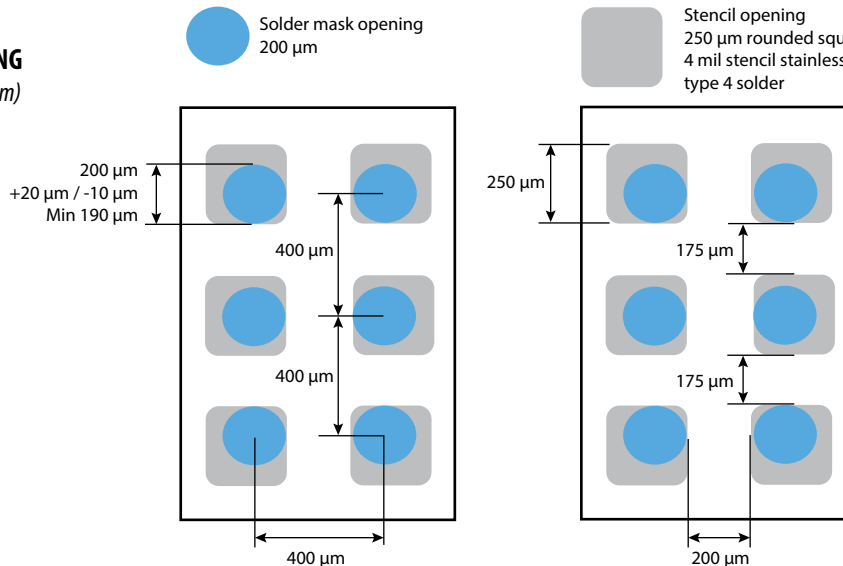

Recommended stencil should be 4 mil (100  $\mu\text{m}$ ) thick, must be laser cut, openings per drawing.

Intended for use with SAC305 Type 4 solder, reference 88.5% metals content.

Additional assembly resources available at  
<https://epc-co.com/epc/DesignSupport/AssemblyBasics.aspx>

Efficient Power Conversion Corporation (EPC) reserves the right to make changes without further notice to any products herein to improve reliability, function or design. EPC does not assume any liability arising out of the application or use of any product or circuit described herein; neither does it convey any license under its patent rights, nor the rights of others.

eGaN® is a registered trademark of Efficient Power Conversion Corporation.  
EPC Patent Listing: [epc-co.com/epc/AboutEPC/Patents.aspx](http://epc-co.com/epc/AboutEPC/Patents.aspx)

Information subject to change without notice.

Revised September, 2019