

Features

- AC and DC Models
- Back-to-Back Dual SCRs (Non-Suffix)
- Internal Snubbers on AC & DC Models
- TRIAC Versions (T-Suffix)
- Random Switching (R-Suffix)
- MOSFET DC Versions (M-Suffix)
- LED Input Status Indicator on Some Models



Ratings

INPUT PARAMETERS				
NTE TYPE No.	Control Signal Range	Must Operate Voltage	Must Release Voltage	Input Current
RS3-1D10-51	3-32VDC	3VDC	1VDC MIN	22mA MAX
RS3-1D10-51R	3-32VDC	3VDC	1VDC MIN	3.4mA TYP
RS3-1A10-52*	100-280VAC	80VAC	20VAC MIN	—
RS3-1A25-42	90-280VAC	90VAC	10VAC MIN	2mA MAX
RS3-1D25-24T	3-32VDC	3VDC	1VDC	4mA MAX
RS3-1A40-22	90-280VAC	90VAC	10VAC MIN	2mA MAX
RS3-1D40-41	3-32VDC	3VDC	1VDC MIN	4mA MAX
RS3-1D40-21*	3-32VDC	—	—	14mA MAX
RS3-1D40-21R*	3-32VDC	—	—	15mA MAX
RS3-1A75-22	90-280VAC	90VAC	10VAC MIN	2mA MAX
RS3-1D75-21*	3-32VDC	—	—	34mA MAX
RS3-1D75-41*	3-32VDC	—	—	34mA MAX
RS3-1D12-41M**	3.5-32VDC	3.5VDC	1VDC MIN	1.6mA MAX
RS3-1D40-41M**	3.5-32VDC	3.5VDC	1VDC MIN	1.6mA MAX

* Contains LED Input Status Indicator

** Does NOT meet CSA approval.

OUTPUT PARAMETERS				
NTE TYPE No.	Line Voltage Range	Max On-State Current	Max 1-Cycle Surge	On-State Voltage Drop
RS3-1D10-51	24-240VAC	10A	40A	1.5V
RS3-1D10-51R	24-240VAC	10A	40A	1.5V
RS3-1A10-52*	24-330VAC	10A	40A	1.5V
RS3-1A25-42	48-240VAC	25A	245	1.6V
RS3-1D25-24T	48-280VAC	25A	215	1.6V
RS3-1A40-22	48-240VAC	40A	245	1.6V
RS3-1D40-41	80-530VAC	40A	600	1.6V
RS3-1D40-21*	24-280VAC	50A	450	1.6V
RS3-1D40-21R*	24-280VAC	45A	450	1.6V
RS3-1A75-22	48-280VAC	75A	950	1.6V
RS3-1D75-21*	24-280VAC	75A	700	1.6V
RS3-1D75-41*	36-530VAC	75A	700	1.6V
RS3-1D12-41M**	0-100VDC	12A	28	1.6V
RS3-1D40-41M**	0-100VDC	40A	106	2.1V

* Contains LED Input Status Indicator

** Does NOT meet CSA approval.

Note 1. Can be used with R95-186, R95-187 or NTE441A Heat Sink.

Note 2. Dust Cover R95-184 Available.

RS3 Series



Panel Mount, Heavy Duty, SPST-NO, Solid State AC and DC Power Relays, 10 Amp to 75 Amp.

D31

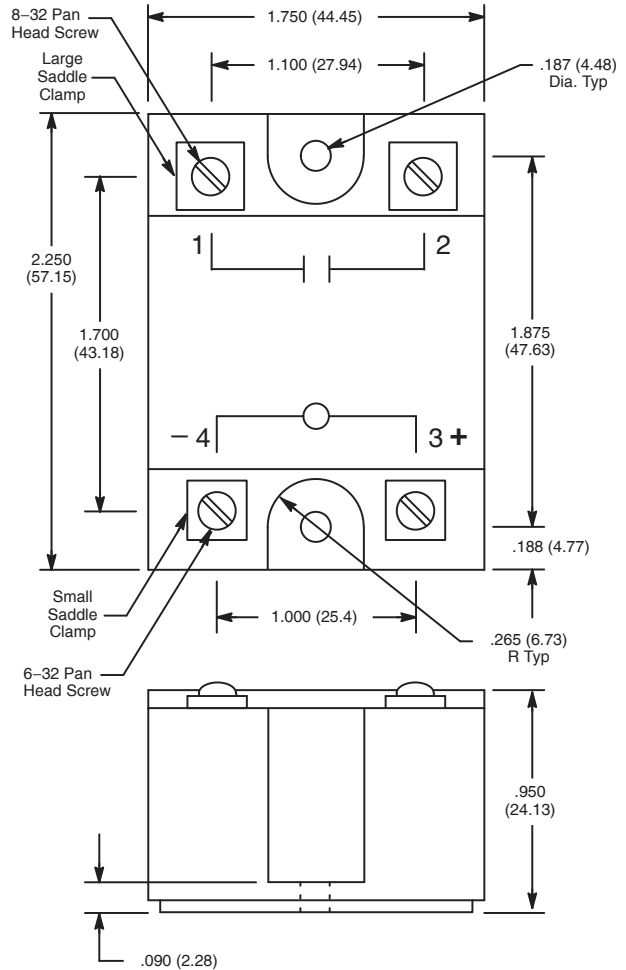

Products and specifications subject to change without notice

Electrical Specifications

Environmental Characteristics

Operating: -40°C to $+80^{\circ}\text{C}$

ACCESSORIES	
DESCRIPTION	NTE TYPE NO.
Dust Cover, Plastic	R95-184
Heat Sink for Solid State Relay	R95-186
Heat Sink for Solid State Relay	R95-187