



Power Factor Correction Boundary Current Mode Method BD7693FJ Reference Board

User's Guide

<High Voltage Safety Precautions>

◇ Read all safety precautions before use

Please note that this document covers only the **BD7693FJ** evaluation board (BD7693FJ-EVK-001) and its functions. For additional information, please refer to the datasheet.

To ensure safe operation, please carefully read all precautions before handling the evaluation board



Depending on the configuration of the board and voltages used,

Potentially lethal voltages may be generated.

Therefore, please make sure to read and observe all safety precautions described in the red box below.

Before Use

- [1] Verify that the parts/components are not damaged or missing (i.e. due to the drops).
- [2] Check that there are no conductive foreign objects on the board.
- [3] Be careful when performing soldering on the module and/or evaluation board to ensure that solder splash does not occur.
- [4] Check that there is no condensation or water droplets on the circuit board.

During Use

- [5] Be careful to not allow conductive objects to come into contact with the board.
- [6] **Brief accidental contact or even bringing your hand close to the board may result in discharge and lead to severe injury or death.**

Therefore, DO NOT touch the board with your bare hands or bring them too close to the board.

In addition, as mentioned above please exercise extreme caution when using conductive tools such as tweezers and screwdrivers.

- [7] If used under conditions beyond its rated voltage, it may cause defects such as short-circuit or, depending on the circumstances, explosion or other permanent damages.
- [8] Be sure to wear insulated gloves when handling is required during operation.

After Use

- [9] The ROHM Evaluation Board contains the circuits which store the high voltage. Since it stores the charges even after the connected power circuits are cut, please discharge the electricity after using it, and please deal with it after confirming such electric discharge.
- [10] Protect against electric shocks by wearing insulated gloves when handling.

This evaluation board is intended for use only in research and development facilities and should be handled **only by qualified personnel familiar with all safety and operating procedures.**

We recommend carrying out operation in a safe environment that includes the use of high voltage signage at all entrances, safety interlocks, and protective glasses.

PFC (power Factor Correction) IC

PFC BCM (Boundary Current Mode) Method Output 200 W 400 V BD7693FJ Reference Board

BD7693FJ-EVK-001

The BD7693FJ-EVK-001 reference board outputs 400 V voltage from the input of 90 Vac to 264 Vac. The output current supplies up to 0.5 A. The BD7693FJ which is BCM method PFC controller IC is used.

The BD7693FJ supplies the system which is suitable for all of products that requires PFC.

BCM is used for PFC part, and Zero Current Detection reduces both switching loss and noise.

THD is less than 6 %.

Electronics Characteristics

Not guarantee the characteristics, is representative value.

Unless otherwise noted; $V_{IN} = 230 \text{ Vac}$, $I_{OUT} = 0.5 \text{ A}$, $T_a = 25 \text{ }^\circ\text{C}$

Parameter		Min	Typ	Max	Units	Conditions
Input Voltage Range	V_{IN}	90	230	264	Vac	
Input Frequency	f_{LINE}	47	50/60	63	Hz	
Output Voltage	V_{OUT}	376	395	414	V	
Maximam Output Power	P_{OUT}	-	-	200	W	$I_{OUT} = 0.5 \text{ A}$
Output Current Range ^(Note 1)	I_{OUT}	0.0	-	0.5	A	
Total Harmonic Distortion(THD)	THD		3.6	6	%	
PF(Power Factor)	PF	0.93	0.97	-	-	AC230 V $I_{OUT} = 0.5 \text{ A}$
Efficiency	η	92	96.	-	%	
Output Ripple Voltage ^(Note 2)	V_R	-	11	20	Vpp	AC90 V $I_{OUT} = 0.5 \text{ A}$
Hold Time	T_{HOLD}	20			ms	$V_{OUT} \text{ min } 280 \text{ V}$
Operating Temperature Range	T_{OP}	-10	+25	+65	$^\circ\text{C}$	

(Note 1) Cool the component surface temperature with FAN, etc., if necessary, and the load application time so that the temperature does not exceed 105 $^\circ\text{C}$.

(Note 2) Not include spike noise

Operation Procedure

1. Operation Equipment

1. AC power supply 90 to 264 Vac, over 200 W
2. Electronic load capacity 0.5 A which supports input voltage 500 V
3. Multi meter
4. Power meter

2. Connect Method

1. AC power supply presetting range 90 to 264 Vac, Output switch is OFF.
2. Electronic load setting under 0.5 A, Load switch is OFF.
3. The reference board connects to measuring equipments and power supplies as in Figure. 1.
4. AC power supply switch is ON.
5. Check that output voltage is 400 V.
6. Electronic load switch is ON.
7. Operate with enough caution against electric shock because of non-isolated output voltage 400 V.

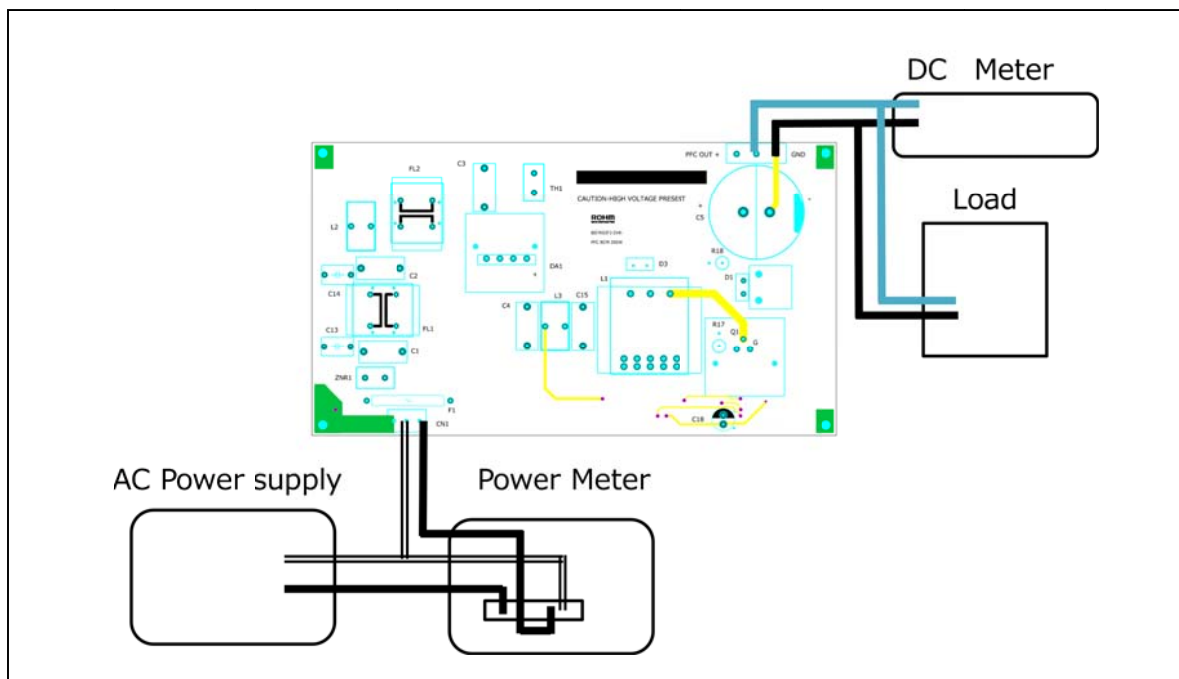

Figure 1. Connection Circuit

Derating

Maximum output power P_o of the reference board is 200 W. The derating curve is shown in Figure. 2.

If ambient temperature is over 40 °C, Consider the load current time and air-cool with FAN so that the component surface temperature does not exceed 105 °C.

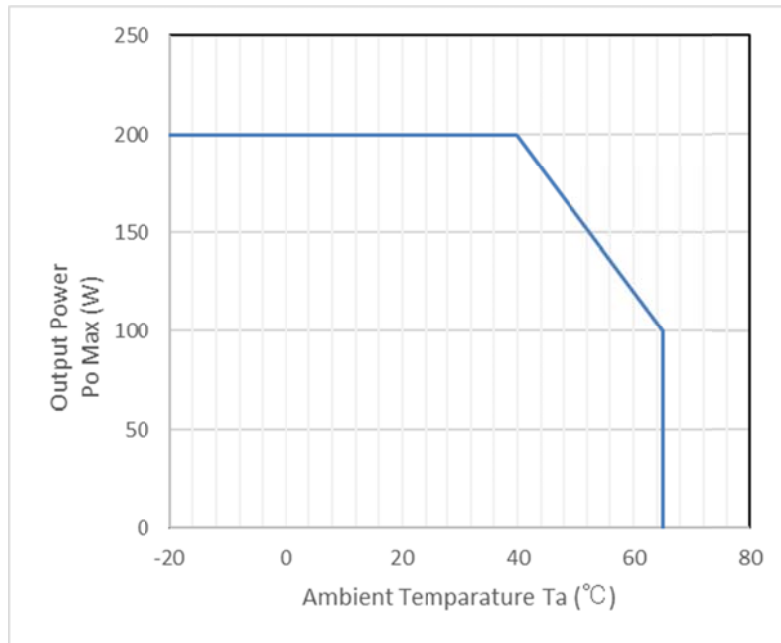

Figure 2. Temperature derating curve

Schematics

$V_{IN} = 90 \text{ to } 264 \text{ Vac}$, $V_{OUT} = 400 \text{ V}$

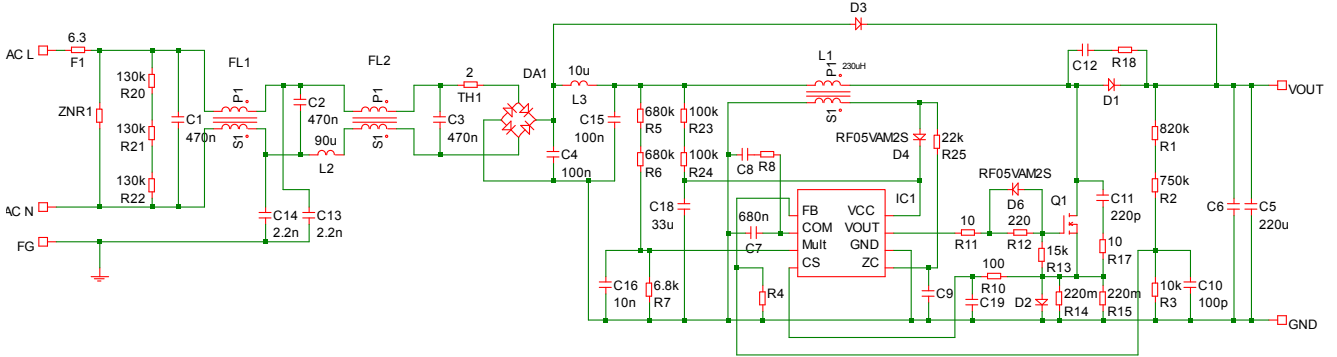

Figure 3. BD7693FJ-EVK-001 Schematics

Bill of Materials

Item	Specifications	Parts name	Manufacture
C1,C2,C3	470 n, 310 Vac	890334025039CS	WURTH ELECTRONIK
C4,C15	0.1 uF, 630 Vdc	890303425004CS	WURTH ELECTRONIK
C5	220 u, 450 V	LGN2W221MELA40	NICHICON
C6,C8,C9,C12,C19,D2,R4,R8,R16,R18,ZNR1	NON MOUNTED		
C7	0.68 uF, 50 V	885012206051_	WURTH ELECTRONIK
C10	100 pF, 100 V	HMK107SD101KA-T	TAIYO YUDEN
C11	220 pF, 2k V	885342209008	WURTH ELECTRONIK
C13,C14	2200 pF, 300 V	DE1E3RA222MJ4BP01F	MURATA
C16	0.01 uF, 50 V	885012206089_	WURTH ELECTRONIK
C18	33 uF, 50 V	86020672012_	WURTH ELECTRONIK
DA1	600 V, 15 A	GBU15J-U1	WILLAS Corp.
D1	FRD,10 A, 600 V	RFNL10TJ6S	ROHM
D3	15A , 600 V	RFNL15TJ6S	ROHM
D4,D6	FRD, 0.5 A, 200 V	RF05VAM2S	ROHM
F1	250 Vac, 6.3 A	VBS UDA-A6.30A	TAN DOE Corp.
IC1		BD7693FJ	ROHM
Q1	600 V, 24 A	R6024KNX	ROHM
R1	820 kΩ	KTR18EZPF8203	ROHM
R2	750 kΩ	KTR18EZPF7503	ROHM
R3	10 kΩ	MCR03EZPFX1002	ROHM
R5,R6	680 kΩ	KTR18EZPJ684	ROHM
R7	6.8 kΩ	MCR03EZPJ682	ROHM
R10	100 Ω	MCR18EZPJ101	ROHM
R11	10 Ω	MCR18EZPJ100	ROHM
R12	220 Ω	MCR18EZPJ221	ROHM
R13	15 kΩ	MCR18EZPJ153	ROHM
R14,R15	220 mΩ	LTR50EZPZFLR220	ROHM
R17	10 Ω	ERG2SJ100V	PANASONIC
TH1	2 Ω, 4 A	2D2-13LD	SEMITEC
R20,R21,R22	130 kΩ	MCR18EZPJ134	ROHM
R23,R24	100 kΩ	MCR18EZPF104	ROHM
R25	22 kΩ	MCR18EZPJ223	ROHM
FL1	35 mH / 3.5 A	7748040435	WURTH ELECTRONIK
FL2	15 mH	GSTC1810-153N	GANG SONG
HEAT1,HEAT3	11.5 K/W	30PBE30-30B	MARUSAN ELECTRONICS
HEAT2	22.9 k/W	IC-1625-STL	SANKYO THRMOTECH
CN1	3pin	B03P – NV(LF)(SN)	JST
CN2	3pin	691137910003_	WURTH ELECTRONIK
L1	230 uH 7.4A	PFC3819QM-231K07D-50	TDK
L2	90 uH	7447013_	WURTH ELECTRONIK
L3	10 uH	744750420100_	WURTH ELECTRONIK

Materials may be changed without notifying.

BD7693FJ Overview

Feature

- Boundary Conduction Mode PFC
- Low THD Circuit Incorporation
- VCC Under Voltage Lock Out Function
- ZCD by Auxiliary Winding
- Static OVP by The VS Pin
- Error Amplifier Input Short Protection
- Stable MOSFET Gate Driving
- Soft Start Function

Key Specification

- Operating Power Supply Voltage Range 10.0 V to 38.0 V
- Circuit Current 0.58 mA (Typ.)
- Operating Temperature Range -40 °C to +105 °C

Package

W(Typ) x D(Typ) x H(Max)

SOP-J8 4.90 mm x 6.00 mm x 1.65 mm
Pitch 1.27 mm

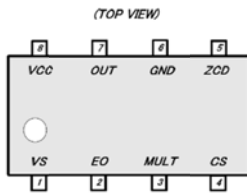

Figure 6. Block Diagram

Table 1. BD7693FJ PIN description

Pin No.	Pin Name	I/O	Function	ESD Diode	
				VCC	GND
1	VS	I	Feedback input pin	-	○
2	EO	O	Error amp output pin	-	○
3	MULT	I	Multiplier input pin	-	○
4	CS	I	Over current protection pin	-	○
5	ZCD	I	Zero current detection pin	-	○
6	GND	-	GND pin	○	-
7	OUT	O	External MOSFET driver pin	-	○
8	VCC	I	Power supply pin	-	○

Performance Data

Load Regulation

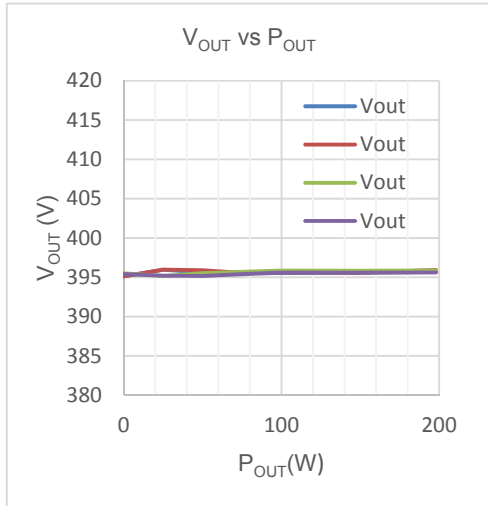

Figure 7. Load Regulation (V_{OUT} vs P_{OUT})

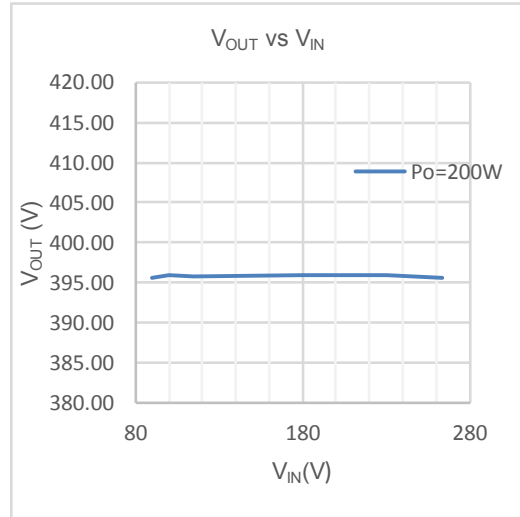

Figure 8. Line Regulation (V_{OUT} vs V_{IN})

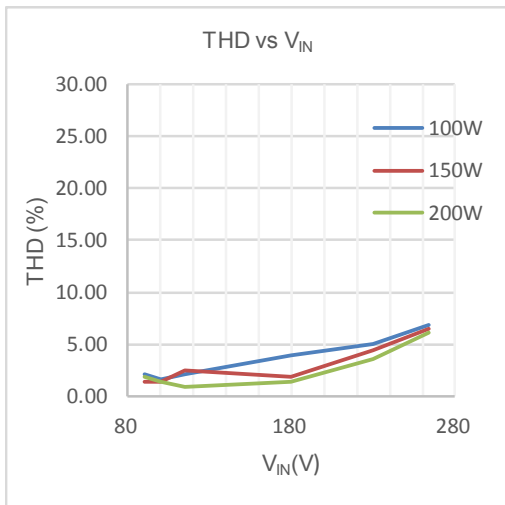

Figure 9. Total Harmonic Distortion (THD vs V_{IN})

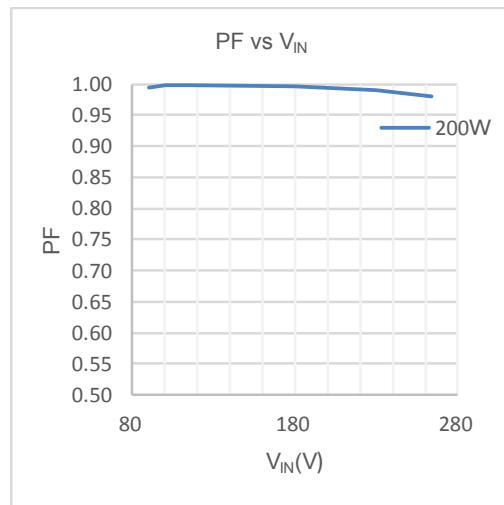

Figure 10. Power Factor (PF vs V_{IN})

Performance data – Continued

Efficiency

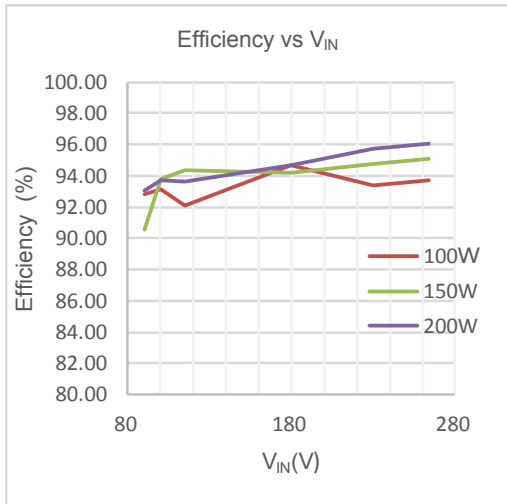

Figure 11. Efficiency (Efficiency vs VIN)

Harmonic Current

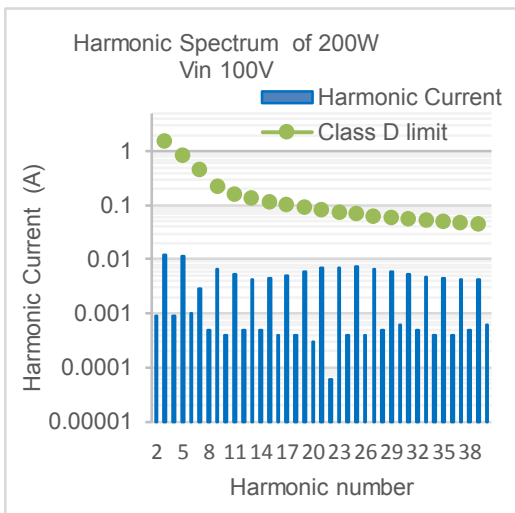

Figure 12. Harmonic Current V_{IN} = 100 V_{ac}

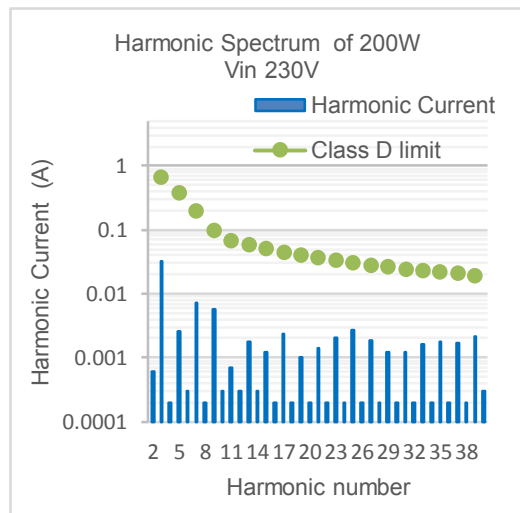

Figure 13. Harmonic Current V_{IN} = 230 V_{ac}

Performance Data – Continued

Input Current

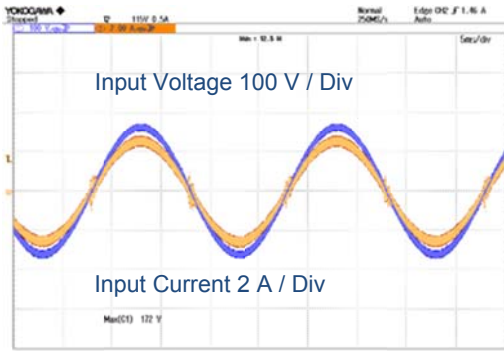

Figure 14. Input Current $V_{IN} = 115 V_{ac}$, $I_{OUT} = 0.5 A$

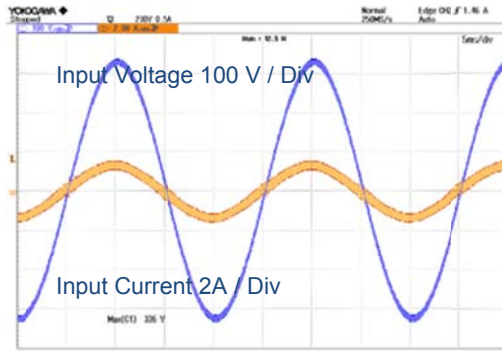

Figure 15. Input Current $V_{IN} = 230 V_{ac}$, $I_{OUT} = 0.5 A$

$V_{DS, Id}$ WaveForm $V_{IN} = 90 V_{ac}$ $I_o = 0.5 A$

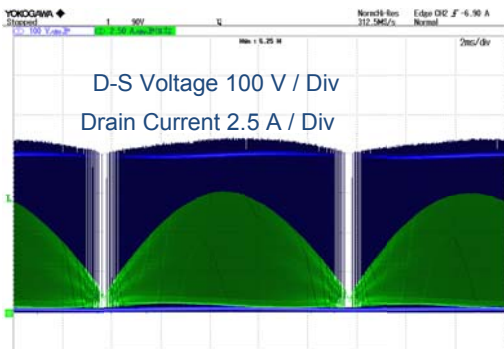

Figure 16. $V_{DS, Id}$ $V_{IN} = 90 V_{ac}$ $I_{OUT} = 0.5 A$

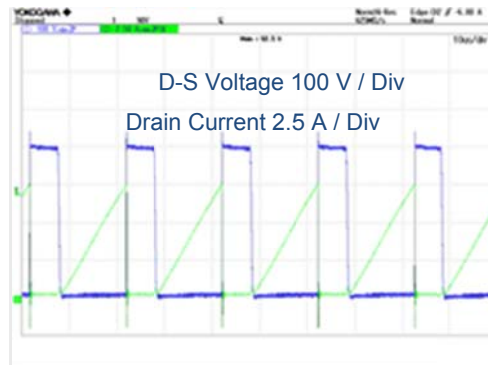

Figure 17. $V_{DS, Id}$ ZOOM

Performance Data – Continued

Hold time

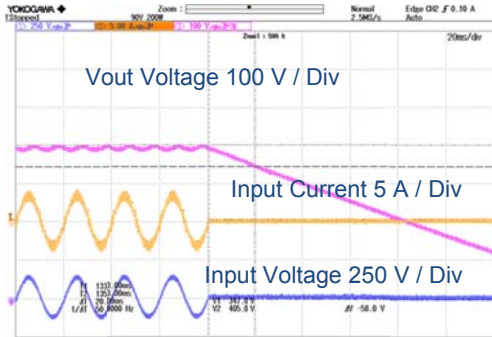

Figure 18. Hold time

Start Up $I_o = 0.5 A$

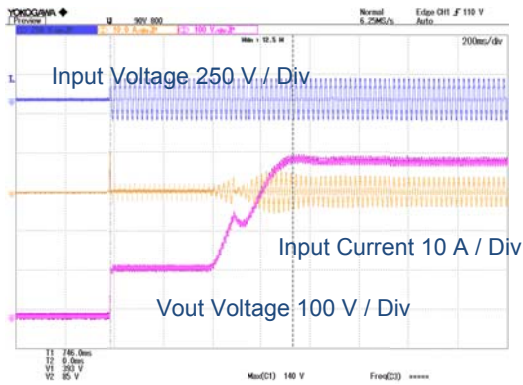

Figure 19. Start Up $V_{IN} = 90 V_{ac}$

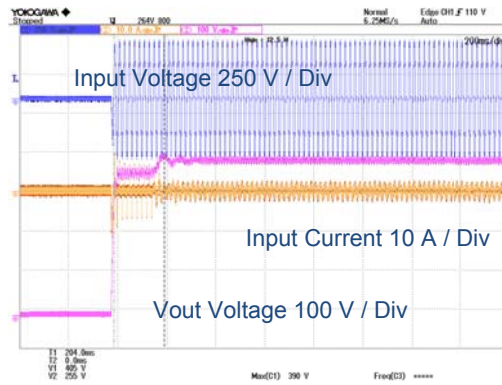

Figure 20. Start Up $V_{IN} = 264 V_{ac}$

Performance Data - Continued

Load Transient $I_o = 0.05\text{ A} \Leftrightarrow 0.5\text{ A}$

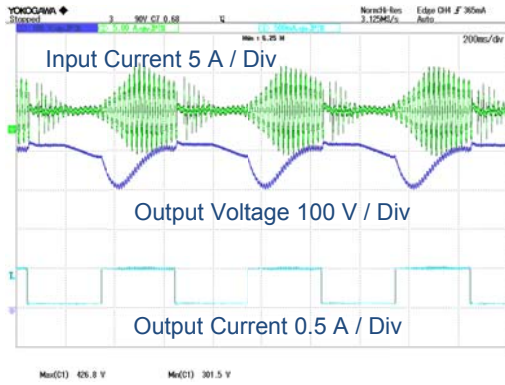

Figure 21. Load Transient $V_{IN} = 90\text{ V}_{ac}$

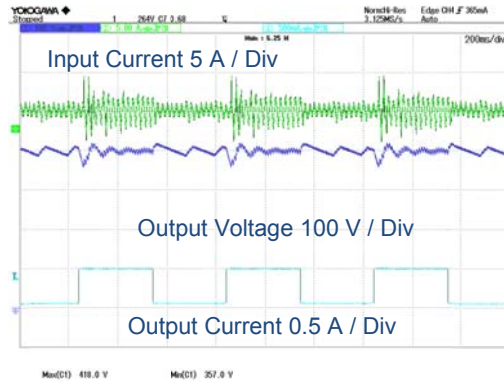

Figure 22. Load Transient $V_{IN} = 264\text{ V}_{ac}$

Output ripple $I_o = 0.5\text{ A}$

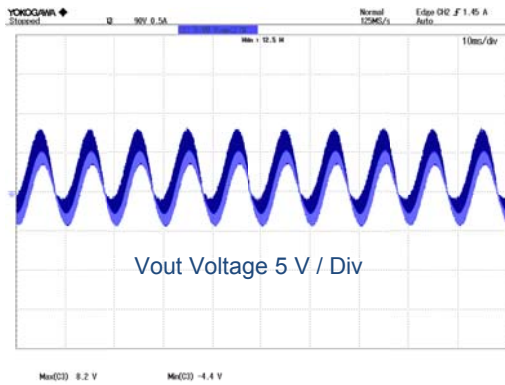

Figure 23. Output ripple $V_{IN} = 90\text{ V}_{ac}$

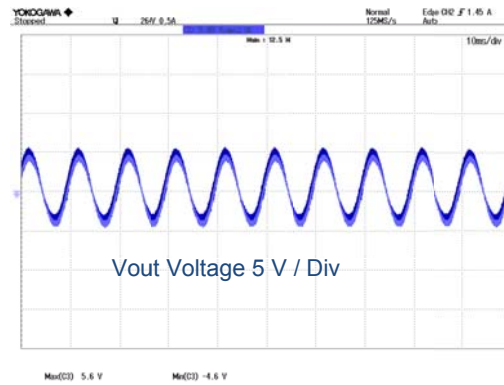

Figure 24. Output ripple $V_{IN} = 264\text{ V}_{ac}$

Performance Data - Continued

EMI

Conducted Emission: CISPR22 Pub 22 Class B

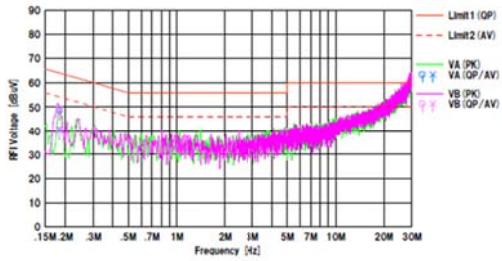

Figure 25. $V_{IN} = 100 V_{ac} / 60 \text{ Hz}$, $I_{OUT} = 0.5 \text{ A}$

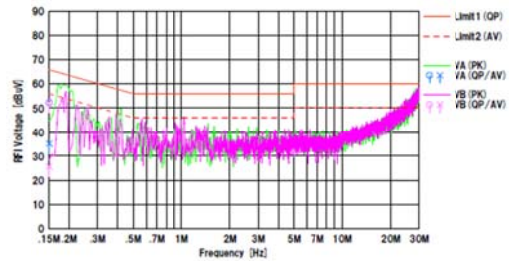

Figure 26. $V_{IN} = 230 V_{ac} / 60 \text{ Hz}$, $I_{OUT} = 0.5 \text{ A}$

Revision History

Date	Rev.	Changes
4.March.2021	001	New Release

Notes

- 1) The information contained herein is subject to change without notice.
- 2) Before you use our Products, please contact our sales representative and verify the latest specifications :
- 3) Although ROHM is continuously working to improve product reliability and quality, semiconductors can break down and malfunction due to various factors.
Therefore, in order to prevent personal injury or fire arising from failure, please take safety measures such as complying with the derating characteristics, implementing redundant and fire prevention designs, and utilizing backups and fail-safe procedures. ROHM shall have no responsibility for any damages arising out of the use of our Products beyond the rating specified by ROHM.
- 4) Examples of application circuits, circuit constants and any other information contained herein are provided only to illustrate the standard usage and operations of the Products. The peripheral conditions must be taken into account when designing circuits for mass production.
- 5) The technical information specified herein is intended only to show the typical functions of and examples of application circuits for the Products. ROHM does not grant you, explicitly or implicitly, any license to use or exercise intellectual property or other rights held by ROHM or any other parties. ROHM shall have no responsibility whatsoever for any dispute arising out of the use of such technical information.
- 6) The Products specified in this document are not designed to be radiation tolerant.
- 7) For use of our Products in applications requiring a high degree of reliability (as exemplified below), please contact and consult with a ROHM representative : transportation equipment (i.e. cars, ships, trains), primary communication equipment, traffic lights, fire/crime prevention, safety equipment, medical systems, servers, solar cells, and power transmission systems.
- 8) Do not use our Products in applications requiring extremely high reliability, such as aerospace equipment, nuclear power control systems, and submarine repeaters.
- 9) ROHM shall have no responsibility for any damages or injury arising from non-compliance with the recommended usage conditions and specifications contained herein.
- 10) ROHM has used reasonable care to ensure the accuracy of the information contained in this document. However, ROHM does not warrants that such information is error-free, and ROHM shall have no responsibility for any damages arising from any inaccuracy or misprint of such information.
- 11) Please use the Products in accordance with any applicable environmental laws and regulations, such as the RoHS Directive. For more details, including RoHS compatibility, please contact a ROHM sales office. ROHM shall have no responsibility for any damages or losses resulting non-compliance with any applicable laws or regulations.
- 12) When providing our Products and technologies contained in this document to other countries, you must abide by the procedures and provisions stipulated in all applicable export laws and regulations, including without limitation the US Export Administration Regulations and the Foreign Exchange and Foreign Trade Act.
- 13) This document, in part or in whole, may not be reprinted or reproduced without prior consent of ROHM.



Thank you for your accessing to ROHM product informations.
More detail product informations and catalogs are available, please contact us.

ROHM Customer Support System

<https://www.rohm.com/contact/>