

SMT Power Inductors

Power Beads - PGL6076.XXXAHLT Series

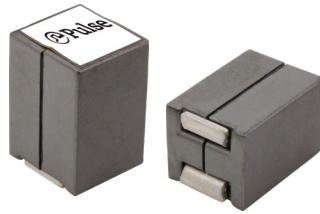

- Ⓢ **Current Rating:** Over 130Apk
- Ⓢ **Inductance Range:** 90nH to 320nH
- Ⓢ **Height:** 12.0mm Max
- Ⓢ **Footprint:** 8.3mm x 7.6mm Max

Electrical Specifications @ 25°C — Operating Temperature - 40°C to +130°C⁷

Part Number	Inductance ¹ @ 0Adc (nH +/- 10%)	Inductance ² @ Irated (nH TYP)	Irated ³ (ADC)	DCR (1-3) (mΩ nominal)	Saturation Current ⁵ (A TYP)		Heating Current ⁶ (A TYP)
					25°C	100°C	
PGL6076.900AHLT	90	90	60	0.155 +/-10%	137	116	60
PGL6076.131AHLT	130	126	60		95	81	60
PGL6076.321AHLT	320	256	37		37	31	60

NOTES:

- Inductance measured at 100kHz, 100mVrms.
- Inductance at Irated is the value of the inductance at 25°C at the listed rated current.
- The rated current as listed is either the saturation current (25°C or 100°C) or the heating current depending on which value is lower.
- The nominal DCR is measured at point $\triangle 2$, as shown below on the mechanical drawing.
- The saturation current is the typical current which causes the inductance to drop by 20% at the stated ambient temperatures (25°C, 100°C). This current is determined by placing the component in the specified ambient environment and applying a short duration pulse current (to eliminate self-heating effects) to the component.
- The heating current is the DC current which causes the part temperature to increase by approximately 40°C when used in a typical application.
- In high volt*time applications, additional heating in the component can occur due to core losses in the inductor which may necessitate derating the current in order to limit the temperature rise of the component. To determine the approximate total losses (or temperature rise) for a given application, the core loss and temperature rise curves can be used.
- Parts with the HLT suffix are sold in tape and reel packaging. Pulse complies to industry standard tape and reel specification EIA-481. The tape and reel for this product has a width (W=24mm), pitch (Po=16mm) and depth (Ko=12.4mm). Samples of these parts can be ordered by removing the HLT suffix and replacing with HL.
- The temperature of the component (ambient plus temperature rise) must be within the stated operating temperature range.
- Sample Value only. Guaranteed by Design and not tested in production

Mechanical

Schematic

PGL6076.XXXAHLT

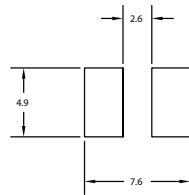

SUGGEST LAND PATTERN

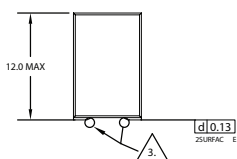
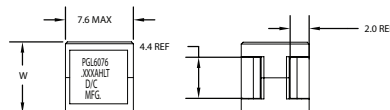

FINAL OUTLINE

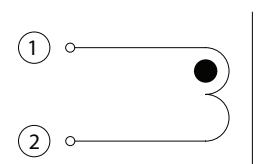

SCHEMATIC

Weight: 3.27grms

Tape & Reel: 250/ Reel

Dimensions: mm

Unless otherwise specified, all tolerances are ± 0.25

TAPE & REEL INFO

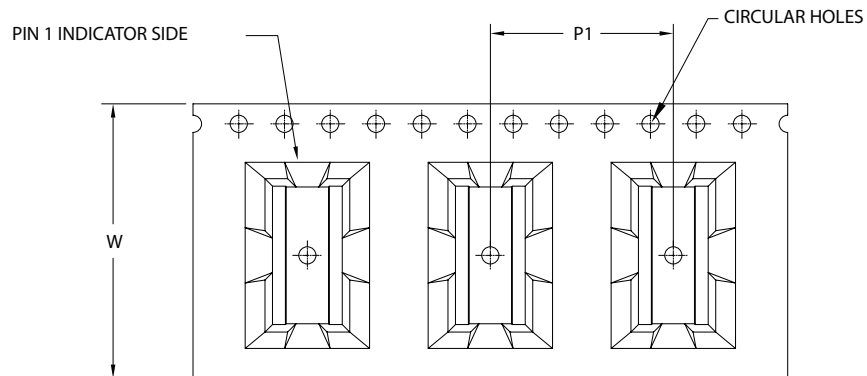

SURFACE MOUNTING TYPE, REEL/TAPE LIST			
TYPE	REEL SIZE (mm)		QTY
	W ± 0.30	P1 ± 0.1	PCS/REEL
PGL6076.XXXALT	24	16	250

PGL6076.900AHLT, L vs I Curve

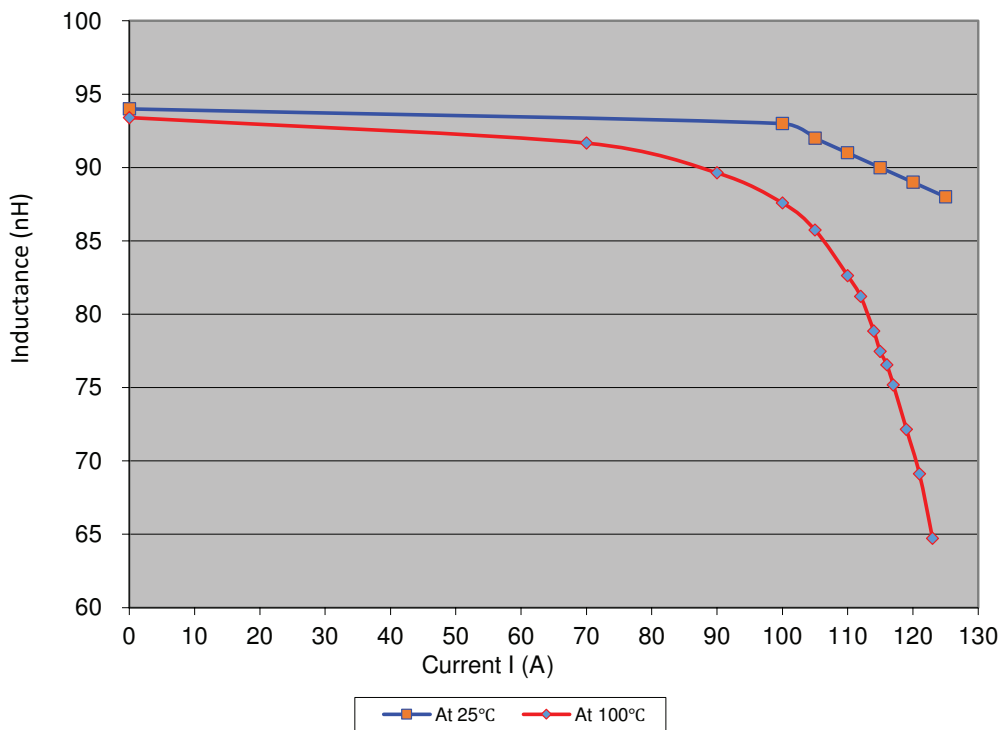

TAPE & REEL INFO

PGL6076.131AHLT, L vs I Curve

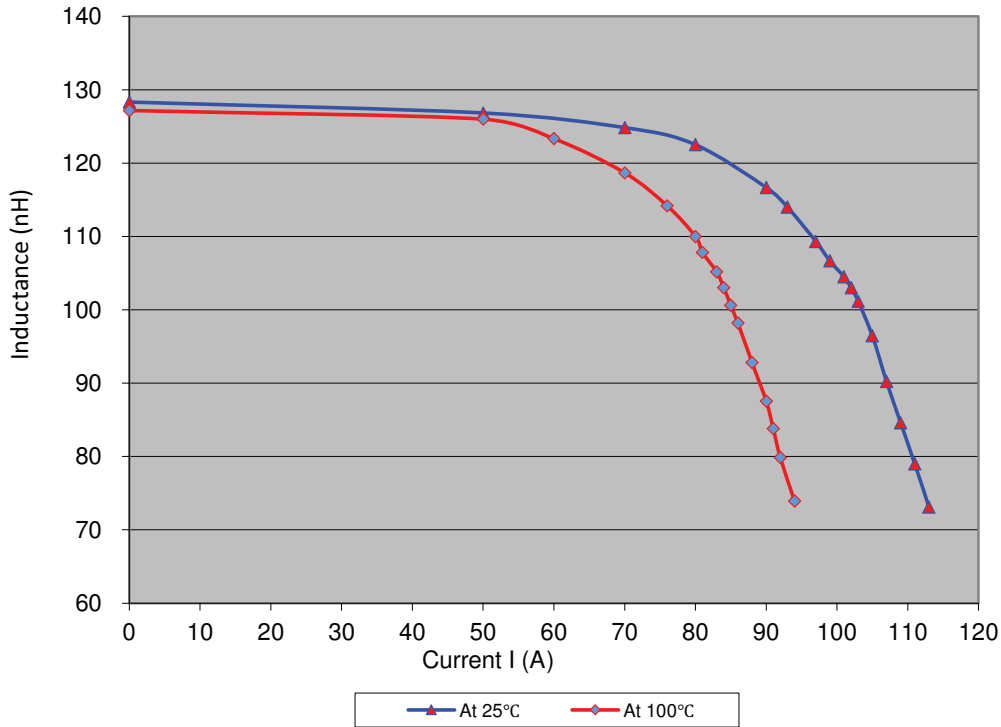

PGL6076.321AHLT, L vs I Curve

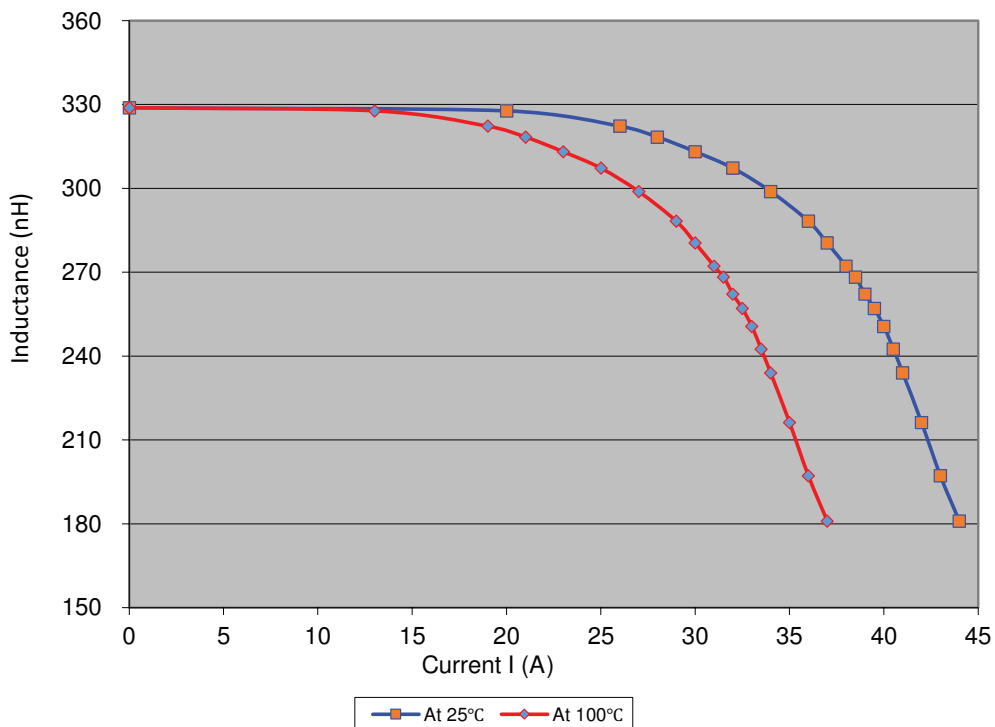

SMT Power Inductors

Power Beads - PGL6076.XXXAHLT Series

PGL6076.XXXAHLT, Core Loss

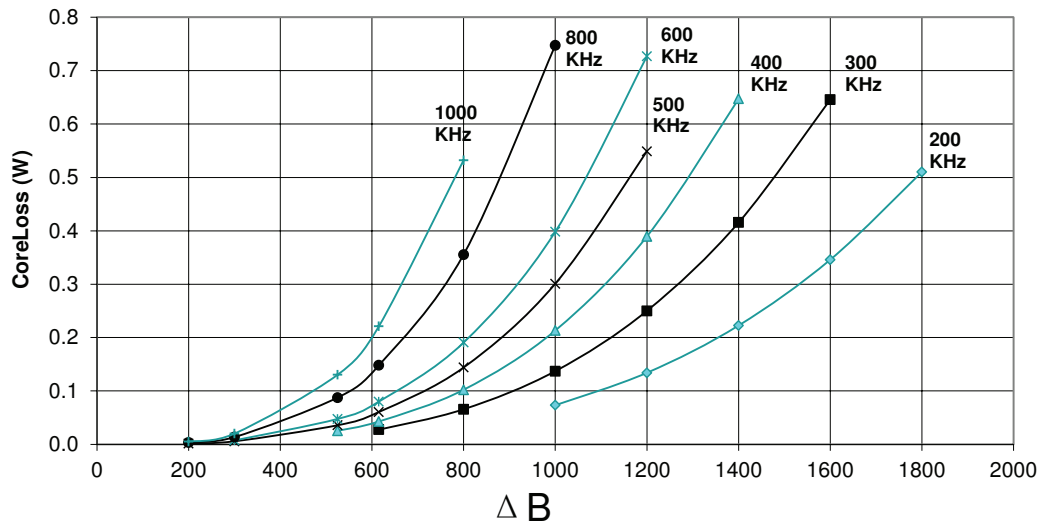

where $\Delta B = 0.32 * L(\text{nH}) * \Delta I$

For More Information:

Americas - prodinfo_power@pulseelectronics.com | Europe - power-apps-europe@pulseelectronics.com | Asia - power-apps-asia@pulseelectronics.com

Performance warranty of products offered on this data sheet is limited to the parameters specified. Data is subject to change without notice. Other brand and product names mentioned herein may be trademarks or registered trademarks of their respective owners. © Copyright, 2021. Pulse Electronics, Inc. All rights reserved.