

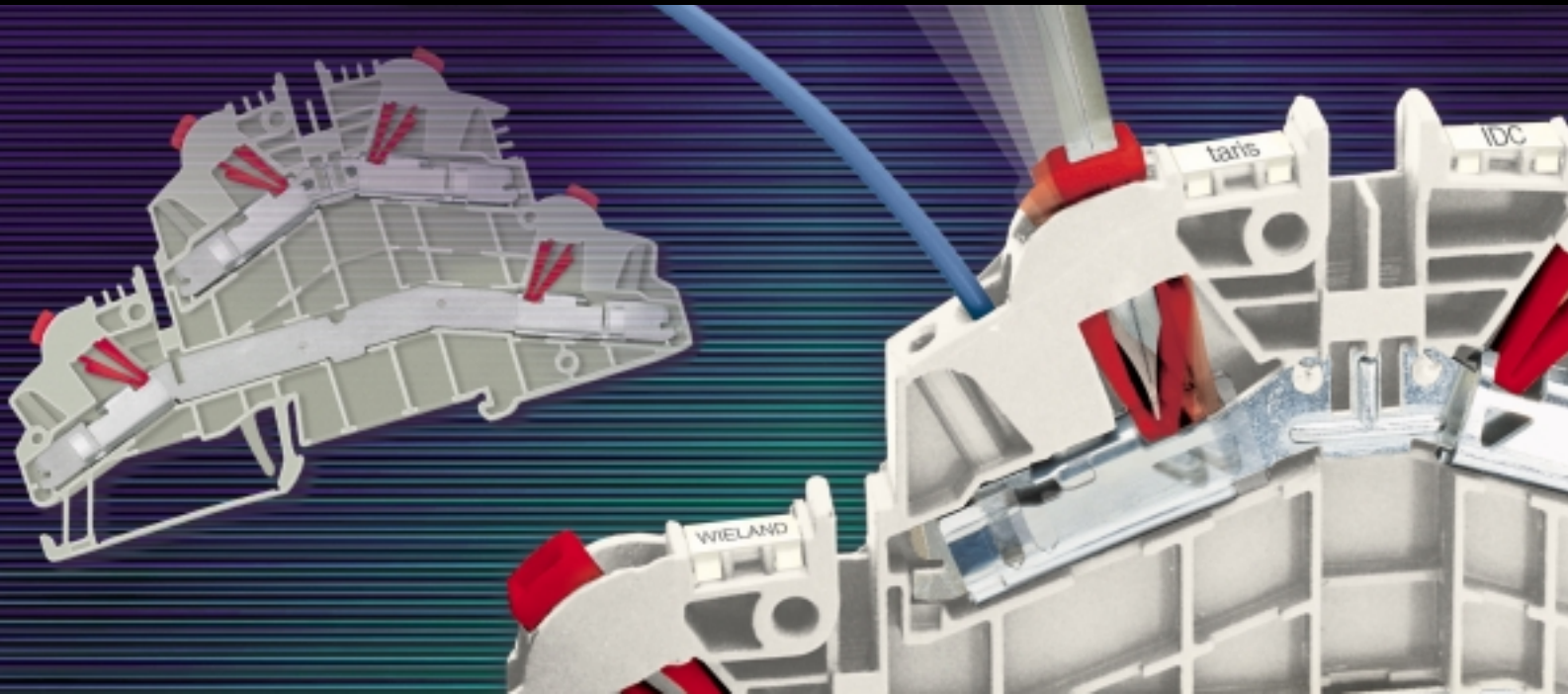







wieland

...your connection to the future™





taris-The industry's most comprehensive family of advanced IDC technology terminal blocks
reduce installation time by 60%, no wire stripping, no special tools required, narrowest IDC blocks capable of accepting 14AWG

IDC DIN Rail Terminal Blocks Type WKC

	1.0 mm ²	2.5 mm ²	taris
Feed-through blocks			
Neutral feed-through blocks			
Ground blocks			

Standard DIN Rail Terminal Blocks

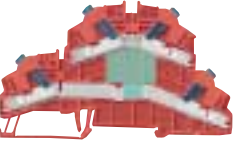
	1.0 mm ²	2.5 mm ²	taris
Double-tier blocks			
Double-tier blocks as function blocks, possible diode switches upon request		 	

Double-tier blocks



taris

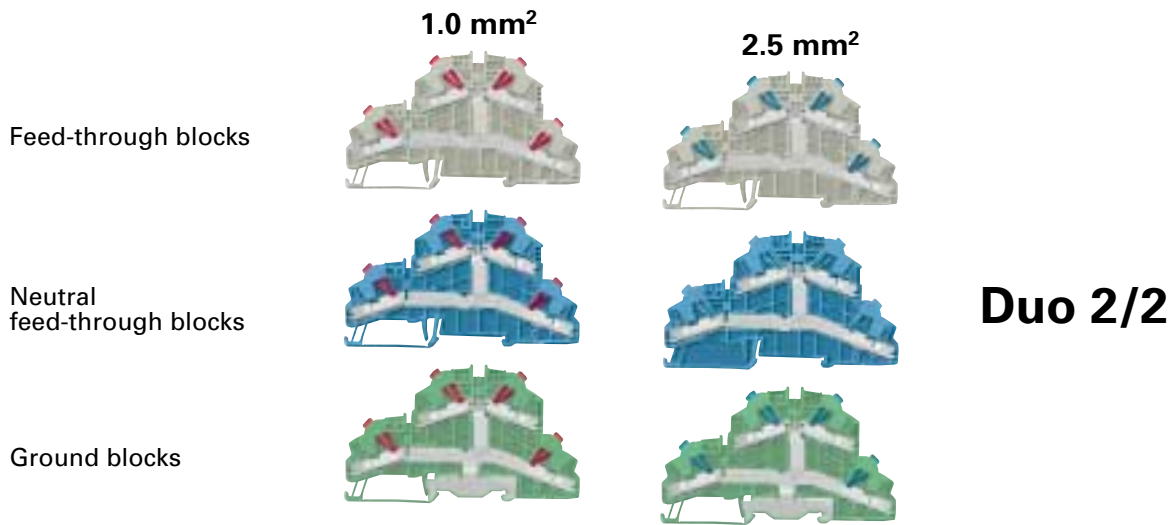
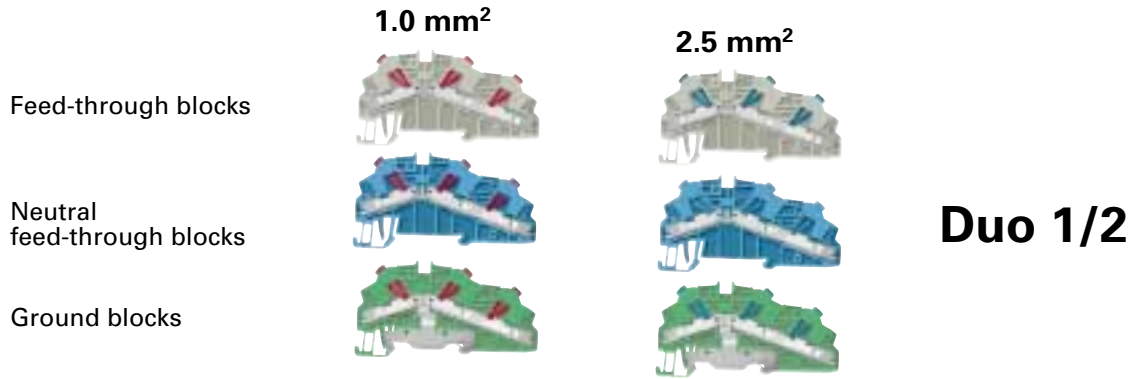

Duo DIN Rail Terminal Blocks

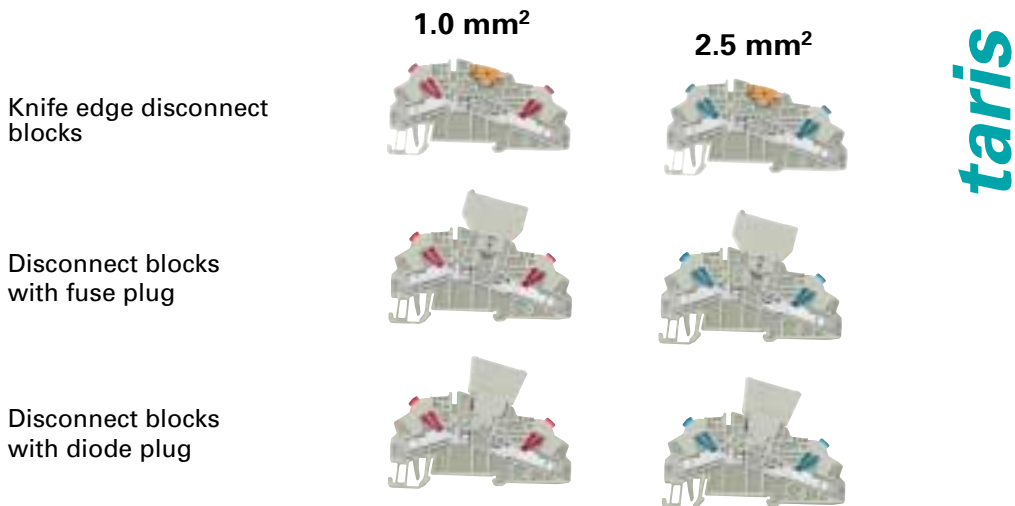

Disconnect Blocks

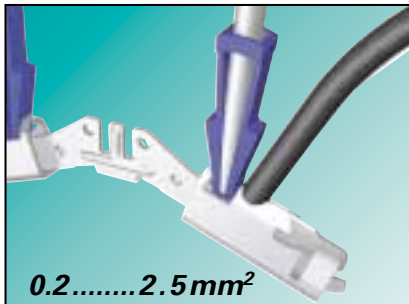

0.2.....2.5 mm²

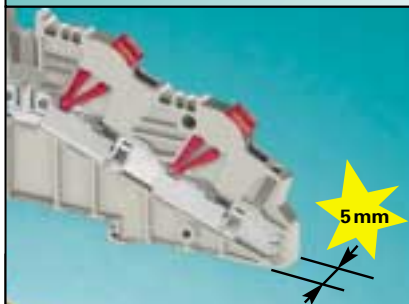
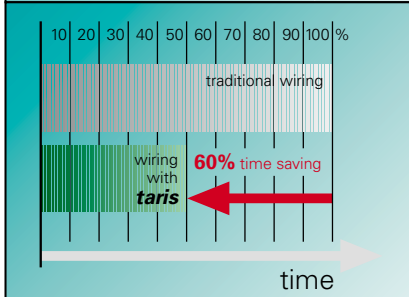

taris Technology

Wieland's **taris** (WKC) Series represents the industry's most comprehensive line of advanced IDC (insulation displacement contact) technology terminal blocks. The superior design of the **taris** IDC contact system reduces wiring installation time and labor, especially in high-volume wiring applications. **taris** IDC terminal blocks are suitable for applications in automated equipment and machine tools, packaging and material handling machinery, railway/mass transit systems, petrochemical, and any applications requiring high-volume interconnects for low-voltage control and signal circuitry where labor cost reduction and ease of assembly is a goal.

taris features

- The industry's narrowest blocks at just 5mm and 6mm wide
- Operates with a standard screwdriver
- Single and dual push-in jumpering slots
- Built-in test points
- Contact design moves the clamp to engage the wire
- Marking tag facilities at each termination point
- Top-entry system puts the wire entry and the screwdriver access in the same plane
- Tin-plated copper alloy contact material
- UL 94-V0 non-flammability rating on the polyamide 6.6 insulation material

benefits

- Uses less space in the cabinet
- No special tools required
- Flexibility in commoning potentials of adjacent blocks
- Provide true measurement reading without removing wires
- Ensures a secure, gas-tight and vibration-resistant connection even when the wire length is maxed out
- Easy circuit identification and troubleshooting
- Facilitates installation even in confined spaces
- Corrosion resistant connection
- Increased safety

WKC Series Terminal Block Versions

- Feed-through
- Ground
- Disconnect
- Fuse
- Arc suppression
- Reverse polarity protection
- 1-in, 2-out feed-through
- 1-in, 2-out ground
- Double-tier feed-through
- Double-tier ground
- Voltage indication



Test Plug

- All **taris** IDC DIN rail terminal blocks feature built-in test points so that measuring values can be taken without removing the wire.
- Entry guides on each side of the blocks permit measuring with standard \varnothing 2.3 mm test probes and test plugs for easy maintenance and trouble-shooting.



Cross connection

- IVB WKF insulated cross connectors offer complete protection from shock-hazard per EN 60352-3/4 and EN 60947-7-1.
- Partition plates between neighboring cross connections are not necessary to meet creepage requirements.
- IVB WKF cross connectors bear the same rated current as the terminal block.



Marking facilities

- Single marking tags
- Snap-On marking strips
- Tear-Off marking strips
- Custom marking options



ADC warning cover

- **taris** offers a Snap-On cover with the ADC warning symbol to prevent tampering of blocks which remain live after the system is switched off. A tool is required to remove the cover for added safety.



DQS certificates for all **taris** products

- DQS is the quality standard per DIN ISO 9001 certification.
- DQS applies to development, production and assembly.
- DQS assures regular internal/external quality audits to maintain Wieland's high quality standards.
- UL and CSA Certifications are pending.

taris materials

taris utilizes special alloys and surface treatments to provide minimal feed-through resistance and a high degree of protection from corrosion. **taris** material composition makes it suitable for use under extreme conditions and guarantees a long-term stable connection. (See catalog section 8: Technical Data for further specs).

taris metal part compositions

- clamping body and power rail are constructed of tin-plated copper
- grounding foot is constructed of tin-plated brass

taris insulating housing compositions

- housings are constructed of polyamide 6.6 for its excellent mechanical, electrical and chemical characteristics
- UL 94-V0 non-flammability rating, the best in the industry

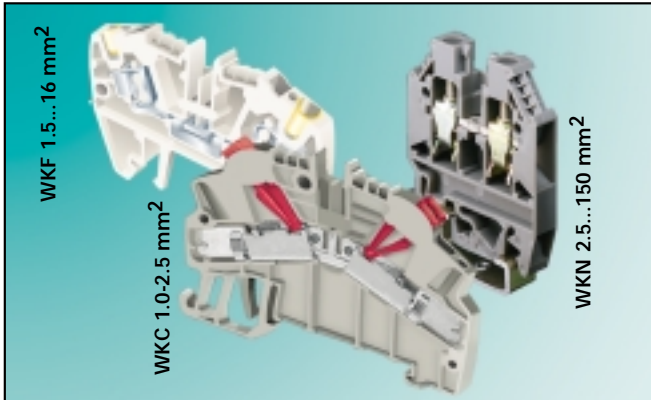

taris

With the addition of **taris** IDC terminal blocks, Wieland now offers the broadest offering of screw clamp, spring clamp and IDC technology, to provide the best possible connection for any control cabinet application. At just 5mm and 6mm wide, the **taris** Series includes the industry's narrowest IDC block capable of accepting 14 AWG. Like other Wieland products, **taris** is designed with superior function and quality in mind, thereby offering the most features and benefits of any terminal block on the market. To lower production costs or reduce installation and maintenance time, Wieland's **taris** WKC Series terminal blocks offer the connection technology you need.

The 2-second Connection

Installing copper wires is easy, fast and safe with **taris**.

- **Easy** – Cut the wire to length and insert into the wire entry guide. Move the clamping body into the wire by inserting and levering a standard flat screwdriver.
- **Fast** – There is no prep time with **taris**- no wire stripping and no ferruling. **taris** reduces installation time by as much as 60%.
- **Safe** – the wire does not move during operation- no risk of losing the wires. No live parts are able to be touched due to the design of the insulating housing. Jumpers are insulated as well.

taris makes disconnecting wires just as easy, fast and safe.

- It is possible to re-use spliced wires with **taris** by cutting the end of the wire before each new/re-termination.
- After connecting a larger wire, a smaller diameter wire can be connected to the same contact.

A color-coded screwdriver guide indicates the rated cross section* of the terminal block:

- WKC 1 24 – 18 AWG **red** indicator
- WKC 2.5 16 – 14 AWG **blue** indicator

*Note: The information regarding cross-sectional areas and connection types pertains to wires without ferrules. The voltage ratings apply to the terminals in their intended application. When different products are mounted adjacent to each other, the proper isolation distances must be maintained. Wieland offers a large selection of accessories. A detailed description of technical data, standard requirements and application conditions is available in catalog section 8 "Technical Explanations".

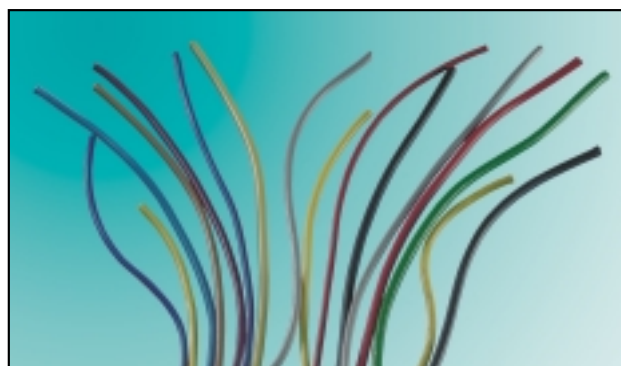
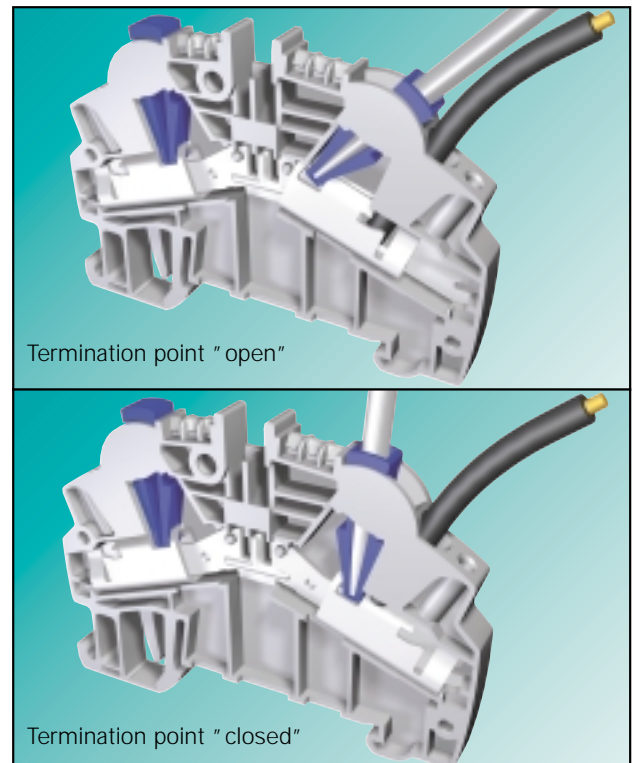

Wire Specifications

taris terminates solid or fine stranded copper wires with AWG between 24 and 14 with two sizes of terminal blocks:

- WKC 1: Copper wire between AWG 24-18; 5 mm wide terminal block
- WKC 2.5: Copper wire between AWG 16-14; 6 mm wide terminal block
- Standard control wire with PVC- and PE- insulation can be terminated. Wire with other insulation material can also be terminated, please consult Wieland for recommendation.
- For fine stranded copper wires, the wire diameter must be a minimum of 0.2 mm. The composition of conductors is based on DIN VDE 0295 Kl. 1-5.

taris

Wire Connection

Insert the wire into the clamping body through the wire entry guide. Insert a flat screwdriver into the colored screwdriver guide and push the screwdriver forward to move the clamping body into the wire. This action cuts the insulation of the wire at two defined points with proper contact and no damage to the copper wire. The result is a gas tight, vibration and corrosion resistant contact.

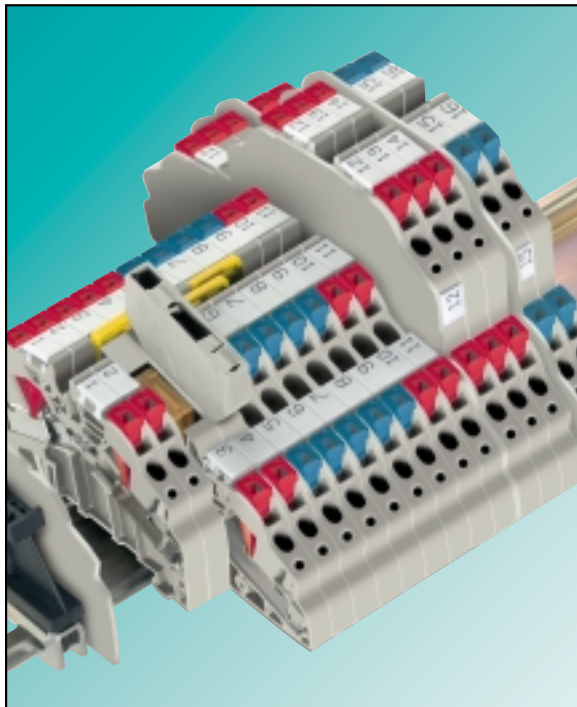
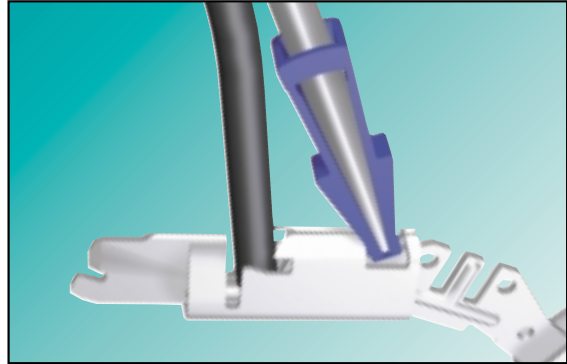

The taris Series

For various application requirements, **taris** offers a variety of terminal blocks in two different ranges of AWG cross sections. Both cross sections have the same contour outside for a clean symmetrical look along the DIN rail.

Standard DIN rail terminal blocks

- DIN rail terminal blocks as feed-through and ground blocks with one termination point on each side of the terminal block
- DIN rail terminal blocks with two jumpering slots provide flexibility in commoning potentials
- DIN rail terminal blocks with marking facilities on every termination point
- DIN rail terminal blocks with test holes for test probes on every termination point

Duo DIN rail terminal blocks

- Duo DIN rail terminal blocks with more than two termination points for one potential
- Duo DIN rail terminal blocks as feed-through and ground blocks in D1/2 and D2/2 version
- Duo DIN rail terminal blocks D1/2 can be jumpered with the standard DIN rail terminal blocks

Disconnect blocks

- as knife edge disconnect blocks or disconnect blocks for diode or fuse plugs
- can be jumpered with standard or Duo 1/2 DIN rail terminal blocks

Double-tier DIN rail terminal blocks

- double-tier blocks with same contour as Duo 2/2 blocks
- double-tier blocks as function block for diode switchings

Accessories

- **taris** utilizes Wieland's standard marking system.
- **taris** utilizes the same insulated cross connectors as Wieland's WKF series spring clamp connection technology for potential commoning.
- For more complex connections, **taris** uses the disconnect block with fuse plug SIST or diode plug DIST from the WK or WKF Series.
- For visual separation of terminal block groups, **taris** offers partitions and end plates, which also maintain shock-hazard protection.
- **taris** features built-in test points which accommodate Wieland test plugs or test probes from standard meters for easy maintenance and trouble-shooting.

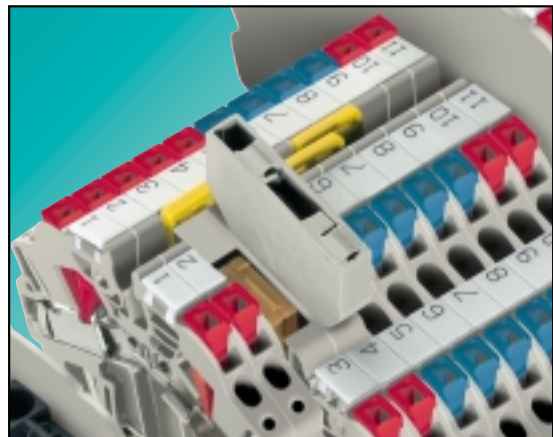

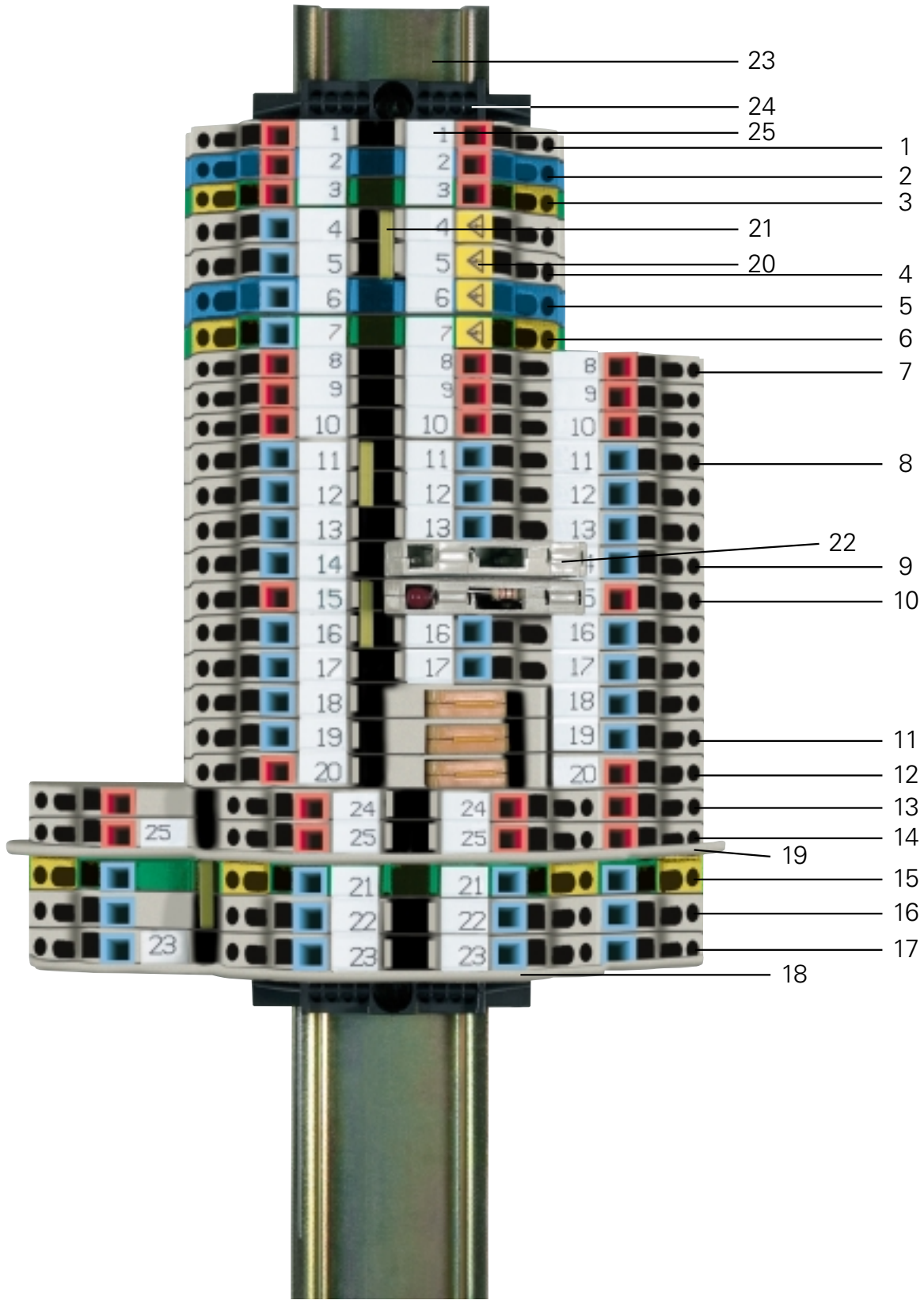

taris Sample Rail

Pos.	Description	Type	Part number
1	Feed-through block	WKC 1/35	56.301.0053.0
2	Feed-through block, blue	WKC 1/35 BLUE	56.301.0053.6
3	Ground block	WKC 1 SL/35	56.301.9053.0
4	Feed-through block	WKC 2.5/35	56.303.0053.0
5	Feed-through block, blue	WKC 2.5/35 BLUE	56.303.0053.6
6	Ground block	WKC 2.5 SL/35	56.303.9053.0
7	Duo feed-through block	WKC 1 D1/2/35	56.301.5053.0
8	Duo feed-through block	WKC 2.5 D1/2/35	56.303.5053.0
9	Disconnect block	WKC 2.5 TKG/35	56.303.4053.0
10	Disconnect block	WKC 1 TKG/35	56.301.4053.0
11	Knife edge disconnect block	WKC 2.5 TKG/35	56.303.2053.0
12	Knife edge disconnect block	WKC 1 TKG/35	56.301.2053.0
13	Duo feed-through block	WKC 1 D2/2/35	56.301.5153.0
14	Double-tier block	WKC 1 E/35	56.301.7053.0
15	Duo ground block	WKC 2.5 D2/2 SL/35	56.303.9153.0
16	Duo feed-through block	WKC 2.5 D2/2/35	56.303.5153.0
17	Double-tier block	WKC 2.5 E/35	56.303.7053.0
18	End plate	APC 1-2.5 D2./E.	07.312.5453.0
19	Partition plate	TWC 1-2.5 D2./E.	07.312.5553.0
20	Cover with warning symbol	ADC 2.5 YELLOW	04.344.0353.8
21	Cross connector, insulated	IVB WKF 4-2	Z7.261.1227.0
22	Fuse plug (G 5x20)	SIST	Z1.299.4053.0
23	Mounting rail	35x27x7.5 EN 50022	98.300.0000.0
24	End brackets	9708/2 S35	Z5.522.8553.0
25	Marking strips	9705 A/5/10 B	04.842.5053.0

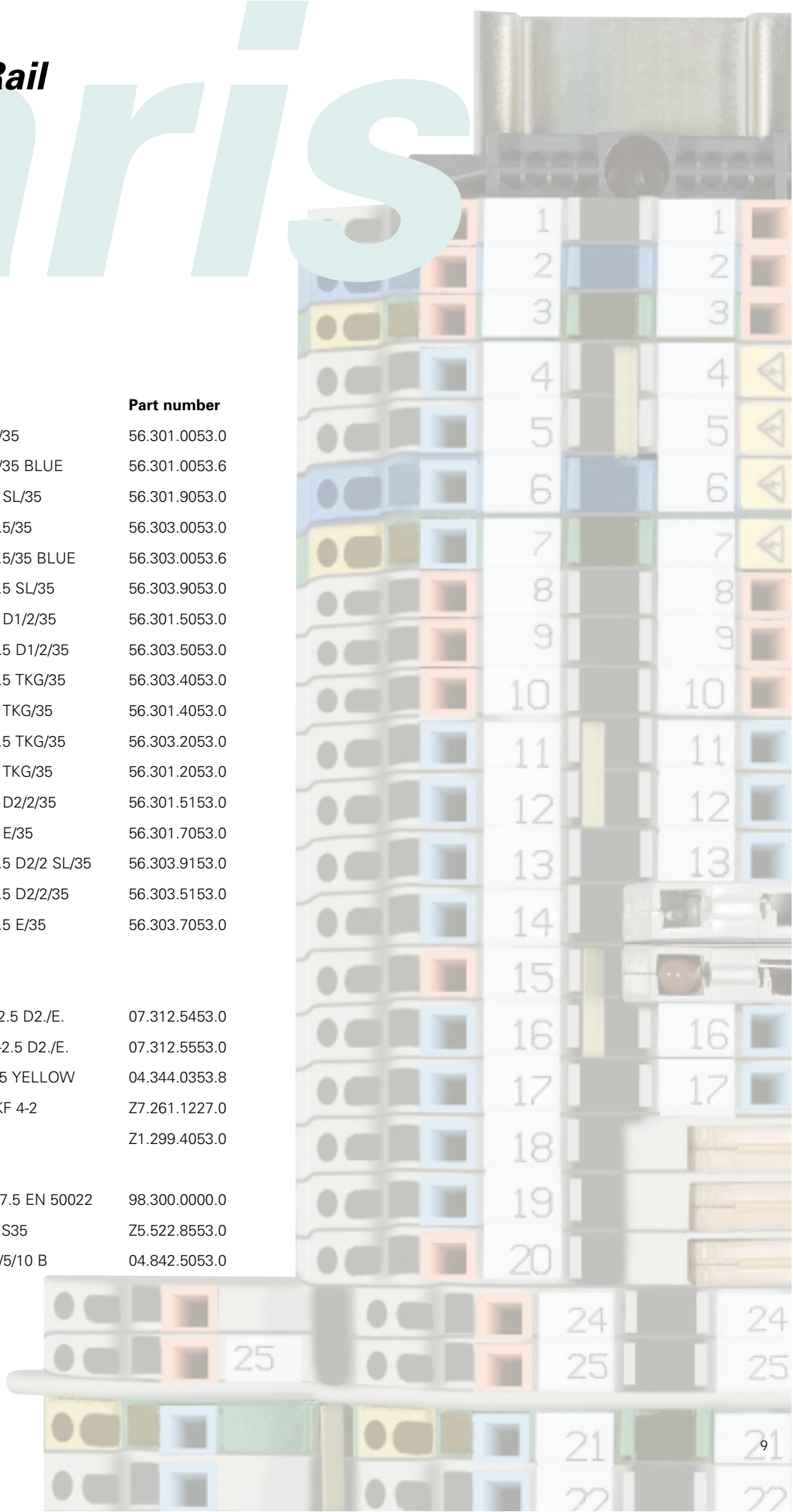

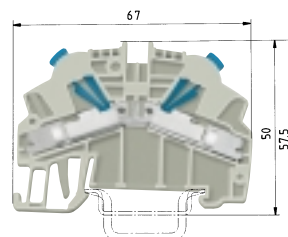
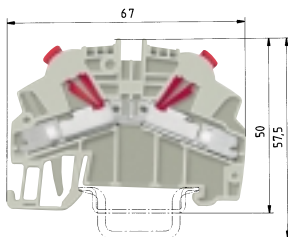

WKC 1/35

fine stranded	stranded	V	A
0.2 – 1 mm ²	0.2 – 1 mm ²	800 V/8kV/3	13.5
No. 24-18 AWG			
No. 24-18 AWG*			
Width	Rated cross section	5 mm	1 mm ²
Approvals	UL, CSA pending		

WKC 2.5/35

fine stranded	stranded	V	A
1 – 2.5 mm ²	1 – 2.5 mm ²	800 V/8kV/3	24
No. 16-14 AWG			
No. 16-14 AWG*			
Width	Rated cross section	6 mm	2.5 mm ²
Approvals	UL, CSA pending		

EN 60 947-7-1

UL ratings

CSA ratings

Width

Approvals

Rated cross section

		Type	Part no.	Std. pack	Type	Part no.	Std. pack
Feed-through block	gray	WKC 1/35	56.301.0053.0	100	WKC 2.5/35	56.303.0053.0	100
Feed-through block	blue	WKC 1/35 BLUE	56.301.0053.6	100	WKC 2.5/35 BLUE	56.303.0053.6	100
Accessories							
1. Mounting rail 35, 7.5 mm high	L = 2 m	35 x 27 x 7.5 EN 50022	98.300.0000.0	1	35 x 27 x 7.5 EN 50022	98.300.0000.0	1
Mounting rail 35, 15 mm high	L = 2 m	35 x 24 x 15 EN 50022	98.360.0000.0	1	35 x 24 x 15 EN 50022	98.360.0000.0	1
2. End brackets for TS 35	8 mm wide	9708/2 S 35	Z5.522.8553.0	100	9708/2 S 35	Z5.522.8553.0	100
3. End plate	gray	APC 1-2.5	07.312.5053.0	10	APC 1-2.5	07.312.5053.0	10
	blue	APC 1-2.5 BLUE	07.312.5053.6	10	APC 1-2.5 BLUE	07.312.5053.6	10
	green						
4. Partition plate	gray	TWC 1-2.5	07.312.5153.0	10	TWC 1-2.5	07.312.5153.0	10
	blue	TWC 1-2.5 BLUE	07.312.5153.6	10	TWC 1-2.5 BLUE	07.312.5153.6	10
5. Cross connector, insulated	2pole	IVB WKF 2.5-2	Z7.280.6227.0	10	IVB WKF 4-2	Z7.261.1227.0	10
	3pole	IVB WKF 2.5-3	Z7.280.6327.0	10	IVB WKF 4-3	Z7.261.1327.0	10
	4pole	IVB WKF 2.5-4	Z7.280.6427.0	10	IVB WKF 4-4	Z7.261.1427.0	10
	5pole	IVB WKF 2.5-5	Z7.280.6527.0	10	IVB WKF 4-5	Z7.261.1527.0	10
	6pole	IVB WKF 2.5-6	Z7.280.6627.0	10	IVB WKF 4-6	Z7.261.1627.0	10
	7pole	IVB WKF 2.5-7	Z7.280.6727.0	20	IVB WKF 4-7	Z7.261.1727.0	20
	8pole	IVB WKF 2.5-8	Z7.280.6827.0	20	IVB WKF 4-8	Z7.261.1827.0	20
	9pole	IVB WKF 2.5-9	Z7.280.6927.0	20	IVB WKF 4-9	Z7.261.1927.0	20
	10pole	IVB WKF 2.5-10	Z7.280.7027.0	20	IVB WKF 4-10	Z7.261.2027.0	20
6. Cover w. warning symbol over 4 blocks		ADC 1 YELLOW	04.344.0153.8	10	ADC 2.5 YELLOW	04.344.0353.8	10
7. Test plug		WK 2.5 ST 2/2.3	Z5.553.2921.0	10	WK 2.5 ST 2/2.3	Z5.553.2921.0	10
8. Screw driver, uninsulated		DIN 5264 B 0.6 x 3.5	06.502.4000.0	5	DIN 5264 B 0.6 x 3.5	06.502.4000.0	5
9. Marking accessories		also see page 21/22			also see page 21/22		
*CSA pending LR 12722							

IDC Ground Blocks Type WKC

taris

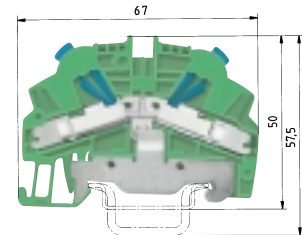
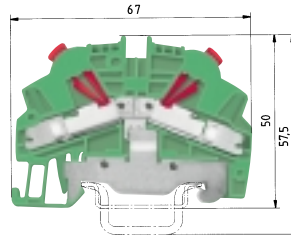

WKC 1 SL/35

fine stranded stranded V A
 0.2 – 1 mm² 0.2 – 1 mm² 800 V/8kV/3 13.5
 No. 24-18 AWG
 No. 24-18 AWG*
 Width Rated cross section 5 mm 1 mm²
 Approvals UL, CSA pending

WKC 2.5 SL/35

fine stranded stranded V A
 1 – 2.5 mm² 1 – 2.5 mm² 800 V/8kV/3 24
 No. 16-14 AWG
 No. 16-14 AWG*
 Width Rated cross section 6 mm 2.5 mm²
 Approvals UL, CSA pending

EN 60 947-7-2
 UL ratings
 CSA ratings
 Width
 Approvals

Rated cross section

		Type	Part no.	Std. pack	Type	Part no.	Std. pack
Ground block	green/yellow	WKC 1 SL/35	56.301.9053.0	100	WKC 2.5 SL/35	56.303.9053.0	100
Accessories							
1. Mounting rail 35, 7.5 mm high	L = 2 m	35 x 27 x 7.5 EN 50022	98.300.0000.0	1	35 x 27 x 7.5 EN 50022	98.300.0000.0	1
Mounting rail 35, 15 mm high	L = 2 m	35 x 24 x 15 EN 50022	98.360.0000.0	1	35 x 24 x 15 EN 50022	98.360.0000.0	1
2. End brackets for TS 35	8 mm wide	9708/2 S 35	Z5.522.8553.0	100	9708/2 S 35	Z5.522.8553.0	100
3. End plate	gray						
	blue						
	green	APC 1-2.5 GREEN	07.312.5053.7	10	APC 1-2.5 GREEN	07.312.5053.7	10
4. Partition plate	gray						
	blue						
5. Cross connector,	2pole						
insulated	3pole						
	4pole						
	5pole						
	6pole						
	7pole						
	8pole						
	9pole						
	10pole						
6. Cover w. warning symbol over 4 blocks		ADC 1 YELLOW	04.344.0153.8	10	ADC 2.5 YELLOW	04.344.0353.8	10
7. Test plug		WK 2.5 ST 2/2.3	Z5.553.2921.0	10	WK 2.5 ST 2/2.3	Z5.553.2921.0	10
8. Screw driver, uninsulated		DIN 5264 B 0.6 x 3.5	06.502.4000.0	5	DIN 5264 B 0.6 x 3.5	06.502.4000.0	5
9. Marking accessories		also see page 21/22			also see page 21/22		
*CSA pending LR 12722							

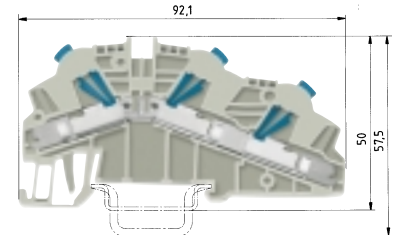
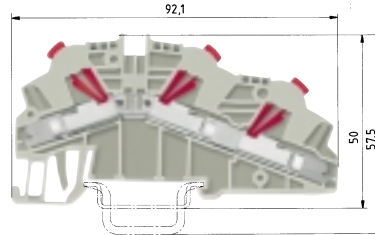

WKC 1 D1/2/35

fine stranded stranded V A
 0.2 – 1 mm² 0.2 – 1 mm² 800 V/8kV/3 13.5
 No. 24-18 AWG
 No. 24-18 AWG*
 Width Rated cross section
 5 mm 1 mm²
 Approvals UL, CSA pending

WKC 2.5 D1/2/35

fine stranded stranded V A
 1 – 2.5 mm² 1 – 2.5 mm² 800 V/8kV/3 24
 No. 16-14 AWG
 No. 16-14 AWG*
 Width Rated cross section
 6 mm 2.5 mm²
 Approvals UL, CSA pending

EN 60 947-7-1
 UL ratings
 CSA ratings
 Width
 Approvals

Rated cross section

		Type	Part no.	Std. pack	Type	Part no.	Std. pack
Duo feed-through block	gray	WKC 1 D1/2/35	56.301.5053.0	50	WKC 2.5 D1/2/35	56.303.5053.0	50
Duo feed-through block	blue	WKC 1 D1/2/35 BLUE	56.301.5053.6	50	WKC 2.5 D1/2/35 BLUE	56.303.5053.6	50
Accessories							
1. Mounting rail 35, 7.5 mm high	L = 2 m	35 x 27 x 7.5 EN 50022	98.300.0000.0	1	35 x 27 x 7.5 EN 50022	98.300.0000.0	1
Mounting rail 35, 15 mm high	L = 2 m	35 x 24 x 15 EN 50022	98.360.0000.0	1	35 x 24 x 15 EN 50022	98.360.0000.0	1
2. End brackets for TS 35	8 mm wide	9708/2 S 35	Z5.522.8553.0	100	9708/2 S 35	Z5.522.8553.0	100
3. End plate	gray	APC 1.5-2.5 D1./TK.	07.312.5253.0	10	APC 1.5-2.5 D1./TK.	07.312.5253.0	10
	blue	APC 1.5-2.5 D1./TK.BLUE	07.312.5253.6	10	APC 1.5-2.5 D1./TK.BLUE	07.312.5253.6	10
	green						
4. Partition plate	gray	TWC 1.5-2.5 D1.	07.312.5353.0	10	TWC 1.5-2.5 D1.	07.312.5353.0	10
	blue	TWC 1.5-2.5 D1. BLUE	07.312.5353.6	10	TWC 1.5-2.5 D1. BLUE	07.312.5353.6	10
5. Cross connector, insulated	2pole	IVB WKF 2.5-2	Z7.280.6227.0	10	IVB WKF 4-2	Z7.261.1227.0	10
	3pole	IVB WKF 2.5-3	Z7.280.6327.0	10	IVB WKF 4-3	Z7.261.1327.0	10
	4pole	IVB WKF 2.5-4	Z7.280.6427.0	10	IVB WKF 4-4	Z7.261.1427.0	10
	5pole	IVB WKF 2.5-5	Z7.280.6527.0	10	IVB WKF 4-5	Z7.261.1527.0	10
	6pole	IVB WKF 2.5-6	Z7.280.6627.0	10	IVB WKF 4-6	Z7.261.1627.0	10
	7pole	IVB WKF 2.5-7	Z7.280.6727.0	20	IVB WKF 4-7	Z7.261.1727.0	20
	8pole	IVB WKF 2.5-8	Z7.280.6827.0	20	IVB WKF 4-8	Z7.261.1827.0	20
	9pole	IVB WKF 2.5-9	Z7.280.6927.0	20	IVB WKF 4-9	Z7.261.1927.0	20
10pole	IVB WKF 2.5-10	Z7.280.7027.0	20	IVB WKF 4-10	Z7.261.2027.0	20	
6. Cover w. warning symbol over 4 blocks		ADC 1 YELLOW	04.344.0153.8	10	ADC 2.5 YELLOW	04.344.0353.8	10
7. Test plug		WK 2.5 ST 2/2.3	Z5.553.2921.0	10	WK 2.5 ST 2/2.3	Z5.553.2921.0	10
8. Screw driver, uninsulated		DIN 5264 B 0.6 x 3.5	06.502.4000.0	5	DIN 5264 B 0.6 x 3.5	06.502.4000.0	5
9. Marking accessories		also see page 21/22			9705 A/5/10	04.242.5053.0	25
*CSA pending LR 12722							

IDC Duo Ground Blocks Type WKC

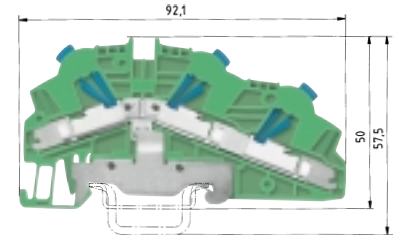
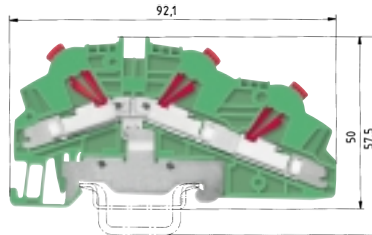

WKC 1 D1/2/SL/35

fine stranded stranded V A
 0.2 – 1 mm² 0.2 – 1 mm² 800 V/8kV/3 13.5
 No. 24-18 AWG
 No. 24-18 AWG*
 Width Rated cross section
 5 mm 1 mm²
 Approvals UL, CSA pending

WKC 2.5 D1/2/SL/35

fine stranded stranded V A
 1 – 2.5 mm² 1 – 2.5 mm² 800 V/8kV/3 24
 No. 16-14 AWG
 No. 16-14 AWG*
 Width Rated cross section
 6 mm 2.5 mm²
 Approvals UL, CSA pending

EN 60 947-7-2

UL ratings

CSA ratings

Width

Approvals

Rated cross section

		Type	Part no.	Std. pack	Type	Part no.	Std. pack
Duo ground block	green/yellow	WKC 1 D1/2/SL/35	56.301.9353.0	50	WKC 2.5 D1/2/SL/35	56.303.9353.0	50
Accessories							
1. Mounting rail 35, 7.5 mm high	L = 2 m	35 x 27 x 7.5 EN 50022	98.300.0000.0	1	35 x 27 x 7.5 EN 50022	98.300.0000.0	1
Mounting rail 35, 15 mm high	L = 2 m	35 x 24 x 15 EN 50022	98.360.0000.0	1	35 x 24 x 15 EN 50022	98.360.0000.0	1
2. End brackets for TS 35	8 mm wide	9708/2 S 35	Z5.522.8553.0	100	9708/2 S 35	Z5.522.8553.0	100
3. End plate	gray						
	blue						
	green	APC 1.5-2.5 D1./TK.GREEN	07.312.5253.7	10	APC 1.5-2.5 D1./TK.GREEN	07.312.5253.7	10
4. Partition plate	gray						
	blue						
5. Cross connector,	2pole						
insulated	3pole						
	4pole						
	5pole						
	6pole						
	7pole						
	8pole						
	9pole						
	10pole						
6. Cover w. warning symbol over 4 blocks		ADC 1 YELLOW	04.344.0153.8	10	ADC 2.5 YELLOW	04.344.0353.8	10
7. Test plug		WK 2.5 ST 2/2.3	Z5.553.2921.0	10	WK 2.5 ST 2/2.3	Z5.553.2921.0	10
8. Screw driver, uninsulated		DIN 5264 B 0.6 x 3.5	06.502.4000.0	5	DIN 5264 B 0.6 x 3.5	06.502.4000.0	5
9. Marking accessories		also see page 21/22			9705 A/5/10	04.242.5053.0	25

*CSA pending LR 12722

IDC Duo Feed-Through Blocks Type WKC

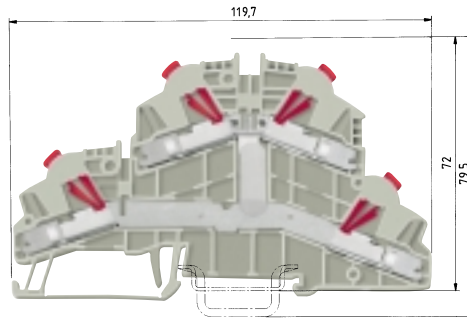

WKC 1 D2/2/35

fine stranded stranded V A
 0.2 – 1 mm² 0.2 – 1 mm² 800 V/8kV/3 13.5
 No. 24-18 AWG
 No. 24-18 AWG*
 5 mm 1 mm²
 UL, CSA pending

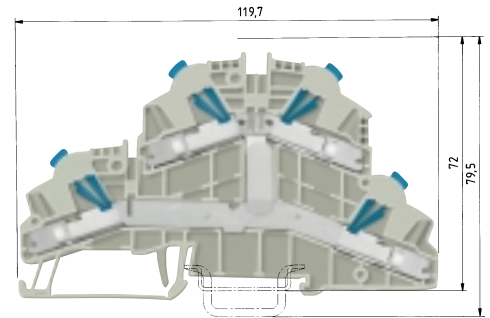

WKC 2.5 D2/2/35

fine stranded stranded V A
 1 – 2.5 mm² 1 – 2.5 mm² 800 V/8kV/3 24
 No. 16-14 AWG
 No. 16-14 AWG*
 6 mm 2.5 mm²
 UL, CSA pending

EN 60 947-7-1

UL ratings

CSA ratings

Width

Approvals

Rated cross section

		Type	Part no.	Std. pack	Type	Part no.	Std. pack
Duo feed-through block	gray	WKC 1 D2/2/35	56.301.5153.0	50	WKC 2.5 D2/2/35	56.303.5153.0	50
Duo feed-through block	blue	WKC 1 D2/2/35 BLUE	56.301.5153.6	50	WKC 2.5 D2/2/35 BLUE	56.303.5153.6	50
Accessories							
1. Mounting rail 35, 7.5 mm high	L = 2 m	35 x 27 x 7.5 EN 50022	98.300.0000.0	1	35 x 27 x 7.5 EN 50022	98.300.0000.0	1
Mounting rail 35, 15 mm high	L = 2 m	35 x 24 x 15 EN 50022	98.360.0000.0	1	35 x 24 x 15 EN 50022	98.360.0000.0	1
2. End brackets for TS 35	8 mm wide	9708/2 S 35	Z5.522.8553.0	100	9708/2 S 35	Z5.522.8553.0	100
3. End plate	gray	APC 1-2.5 D2./E.	07.312.5453.0	10	APC 1-2.5 D2./E.	07.312.5453.0	10
	blue	APC 1-2.5 D2./E. BLUE	07.312.5453.6	10	APC 1-2.5 D2./E. BLUE	07.312.5453.6	10
	green						
4. Partition plate	gray	TWC 1-2.5 D2./E.	07.312.5553.0	10	TWC 1-2.5 D2./E.	07.312.5553.0	10
	blue	TWC 1-2.5 D2./E. BLUE	07.312.5553.6	10	TWC 1-2.5 D2./E. BLUE	07.312.5553.6	10
5. Cross connector, insulated	2pole	IVB WKF 2.5-2	Z7.280.6227.0	10	IVB WKF 4-2	Z7.261.1227.0	10
	3pole	IVB WKF 2.5-3	Z7.280.6327.0	10	IVB WKF 4-3	Z7.261.1327.0	10
	4pole	IVB WKF 2.5-4	Z7.280.6427.0	10	IVB WKF 4-4	Z7.261.1427.0	10
	5pole	IVB WKF 2.5-5	Z7.280.6527.0	10	IVB WKF 4-5	Z7.261.1527.0	10
	6pole	IVB WKF 2.5-6	Z7.280.6627.0	10	IVB WKF 4-6	Z7.261.1627.0	10
	7pole	IVB WKF 2.5-7	Z7.280.6727.0	20	IVB WKF 4-7	Z7.261.1727.0	20
	8pole	IVB WKF 2.5-8	Z7.280.6827.0	20	IVB WKF 4-8	Z7.261.1827.0	20
	9pole	IVB WKF 2.5-9	Z7.280.6927.0	20	IVB WKF 4-9	Z7.261.1927.0	20
	10pole	IVB WKF 2.5-10	Z7.280.7027.0	20	IVB WKF 4-10	Z7.261.2027.0	20
	6. Cover w. warning symbol over 4 blocks		ADC 1 YELLOW	04.344.0153.8	10	ADC 2.5 YELLOW	04.344.0353.8
7. Test plug		WK 2.5 ST 2/2.3	Z5.553.2921.0	10	WK 2.5 ST 2/2.3	Z5.553.2921.0	10
8. Screw driver, uninsulated		DIN 5264 B 0.6 x 3.5	06.502.4000.0	5	DIN 5264 B 0.6 x 3.5	06.502.4000.0	5
9. Marking accessories		also see page 21/22			also see page 21/22		
*CSA pending LR 12722							

IDC Duo Ground Blocks Type WKC

taris

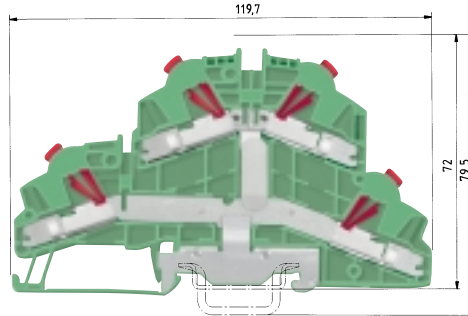

WKC 1 D2/2/SL/35

fine stranded	stranded	V	A
0.2 – 1 mm ²	0.2 – 1 mm ²	800 V/8kV/3	13.5
No. 24-18 AWG			
No. 24-18 AWG*			
5 mm		1 mm ²	
UL, CSA pending			

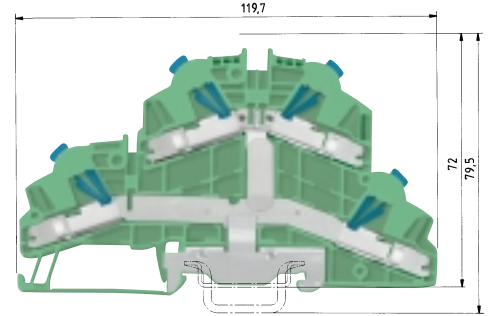

WKC 2.5 D2/2/SL/35

fine stranded	stranded	V	A
1 – 2.5 mm ²	1 – 2.5 mm ²	800 V/8kV/3	24
No. 16-14 AWG			
No. 16-14 AWG*			
6 mm		2.5 mm ²	
UL, CSA pending			

EN 60 947-7-2

UL ratings

CSA ratings

Width

Approvals

Rated cross section

		Type	Part no.	Std. pack	Type	Part no.	Std. pack
Duo ground block	green/yellow	WKC 1 D2/2/SL/35	56.301.9153.0	50	WKC 2.5 D2/2/SL/35	56.303.9153.0	50
Accessories							
1. Mounting rail 35, 7.5 mm high	L = 2 m	35 x 27 x 7.5 EN 50022	98.300.0000.0	1	35 x 27 x 7.5 EN 50022	98.300.0000.0	1
Mounting rail 35, 15 mm high	L = 2 m	35 x 24 x 15 EN 50022	98.360.0000.0	1	35 x 24 x 15 EN 50022	98.360.0000.0	1
2. End brackets for TS 35	8 mm wide	9708/2 S 35	Z5.522.8553.0	100	9708/2 S 35	Z5.522.8553.0	100
3. End plate	gray						
	blue						
	green	APC 1-2.5 D2./E. GREEN	07.312.5453.7	10	APC 1-2.5 D2./E. GREEN	07.312.5453.7	10
4. Partition plate	gray						
	blue						
5. Cross connector,	2pole						
insulated	3pole						
	4pole						
	5pole						
	6pole						
	7pole						
	8pole						
	9pole						
	10pole						
6. Cover w. warning symbol over 4 blocks		ADC 1 YELLOW	04.344.0153.8	10	ADC 2.5 YELLOW	04.344.0353.8	10
7. Test plug		WK 2.5 ST 2/2.3	Z5.553.2921.0	10	WK 2.5 ST 2/2.3	Z5.553.2921.0	10
8. Screw driver, uninsulated		DIN 5264 B 0.6 x 3.5	06.502.4000.0	5	DIN 5264 B 0.6 x 3.5	06.502.4000.0	5
9. Marking accessories		also see page 21/22			also see page 21/22		
*CSA pending LR 12722							

IDC Double-Tier Blocks Type WKC

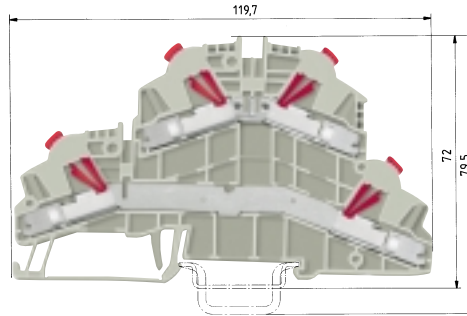

WKC 1 E/35

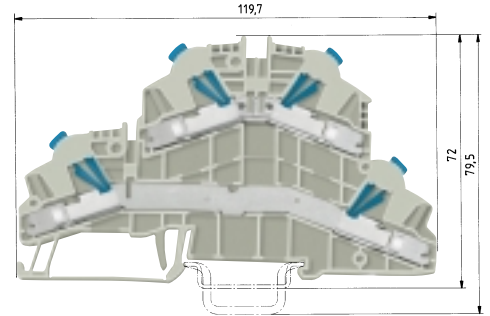

WKC 2.5 E/35

EN 60 947-7-1

UL ratings

CSA ratings

Width

Approvals

Rated cross section

fine stranded stranded V A
 0.2 – 1 mm² 0.2 – 1 mm² 500 V/6kV/3 13.5
 No. 24-18 AWG
 No. 24-18 AWG*
 5 mm 1 mm²
 UL, CSA pending

fine stranded stranded V A
 1 – 2.5 mm² 1 – 2.5 mm² 500 V/6kV/3 24
 No. 16-14 AWG
 No. 16-14 AWG*
 6 mm 2.5 mm²
 UL, CSA pending

		Type	Part no.	Std. pack	Type	Part no.	Std. pack
Double-tier block	gray	WKC 1 E/35	56.301.7053.0	50	WKC 2.5 E/35	56.303.7053.0	50
Accessories							
1. Mounting rail 35, 7.5 mm high	L = 2 m	35 x 27 x 7.5 EN 50022	98.300.0000.0	1	35 x 27 x 7.5 EN 50022	98.300.0000.0	1
Mounting rail 35, 15 mm high	L = 2 m	35 x 24 x 15 EN 50022	98.360.0000.0	1	35 x 24 x 15 EN 50022	98.360.0000.0	1
2. End brackets for TS 35	8 mm wide	9708/2 S 35	Z5.522.8553.0	100	9708/2 S 35	Z5.522.8553.0	100
3. End plate	gray	APC 1-2.5 D2./E.	07.312.5453.0	10	APC 1-2.5 D2./E.	07.312.5453.0	10
	blue						
	green						
4. Partition plate	gray	TWC 1-2.5 D2./E.	07.312.5553.0	10	TWC 1-2.5 D2./E.	07.312.5553.0	10
	blue	TWC 1-2.5 D2./E. BLUE	07.312.5553.6	10	TWC 1-2.5 D2./E. BLUE	07.312.5553.6	10
5. Cross connector,	2pole	IVB WKF 2.5-2	Z7.280.6227.0	10	IVB WKF 4-2	Z7.261.1227.0	10
insulated	3pole	IVB WKF 2.5-3	Z7.280.6327.0	10	IVB WKF 4-3	Z7.261.1327.0	10
	4pole	IVB WKF 2.5-4	Z7.280.6427.0	10	IVB WKF 4-4	Z7.261.1427.0	10
	5pole	IVB WKF 2.5-5	Z7.280.6527.0	10	IVB WKF 4-5	Z7.261.1527.0	10
	6pole	IVB WKF 2.5-6	Z7.280.6627.0	10	IVB WKF 4-6	Z7.261.1627.0	10
	7pole	IVB WKF 2.5-7	Z7.280.6727.0	20	IVB WKF 4-7	Z7.261.1727.0	20
	8pole	IVB WKF 2.5-8	Z7.280.6827.0	20	IVB WKF 4-8	Z7.261.1827.0	20
	9pole	IVB WKF 2.5-9	Z7.280.6927.0	20	IVB WKF 4-9	Z7.261.1927.0	20
	10pole	IVB WKF 2.5-10	Z7.280.7027.0	20	IVB WKF 4-10	Z7.261.2027.0	20
6. Cover w. warning symbol over 4 blocks		ADC 1 YELLOW	04.344.0153.8	10	ADC 2.5 YELLOW	04.344.0353.8	10
7. Test plug		WK 2.5 ST 2/2.3	Z5.553.2921.0	10	WK 2.5 ST 2/2.3	Z5.553.2921.0	10
8. Screw driver, uninsulated		DIN 5264 B 0.6 x 3.5	06.502.4000.0	5	DIN 5264 B 0.6 x 3.5	06.502.4000.0	5
9. Marking accessories		also see page 21/22			also see page 21/22		
*CSA pending LR 12722							

IDC Function Blocks

Type WKC

taris

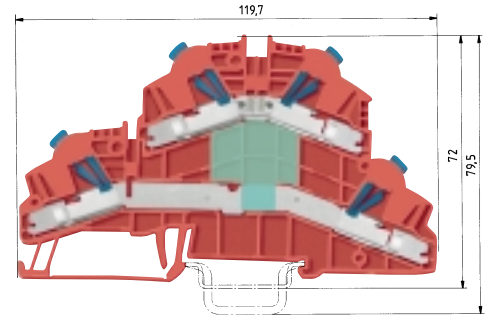
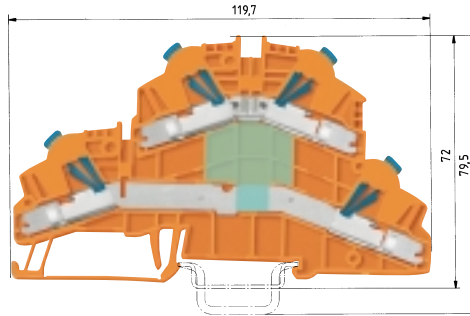

WKC 2.5 E/35...

fine stranded stranded V A

1 – 2.5 mm² 1 – 2.5 mm²

No. 24-18 AWG

No. 24-18 AWG*

6 mm 2.5 mm²

UL, CSA pending

EN 60 947-7-1

UL ratings

CSA ratings

Width

Rated cross section

Approvals

The double-tier block is available upon request as function block for most different connection tasks.

Examples of functions

	Type	Part no.	Std. pack
Double-tier block	red	WKC 2.5 E/35...	56.303.xx53.5 50
	orange	WKC 2.5 E/35...	56.303.xx53.9 50
Accessories			
1. Mounting rail 35, 7.5 mm high	L = 2 m	35 x 27 x 7.5 EN 50022	98.300.0000.0 1
Mounting rail 35, 15 mm high	L = 2 m	35 x 24 x 15 EN 50022	98.360.0000.0 1
2. End brackets for TS 35	8 mm wide	9708/2 S 35	Z5.522.8553.0 100
3. End plate	gray	APC 1-2.5 D2./E.	07.312.5453.0 10
	blue		
	green		
4. Partition plate	gray	TWC 1-2.5 D2./E.	07.312.5553.0 10
	blue	TWC 1-2.5 D2./E. BLUE	07.312.5553.6 10
5. Cross connector, insulated	2pole	IVB WKF 2.5-2	Z7.280.6227.0 10
	3pole	IVB WKF 2.5-3	Z7.280.6327.0 10
	4pole	IVB WKF 2.5-4	Z7.280.6427.0 10
	5pole	IVB WKF 2.5-5	Z7.280.6527.0 10
	6pole	IVB WKF 2.5-6	Z7.280.6627.0 10
	7pole	IVB WKF 2.5-7	Z7.280.6727.0 20
	8pole	IVB WKF 2.5-8	Z7.280.6827.0 20
9pole	IVB WKF 2.5-9	Z7.280.6927.0 20	
10pole	IVB WKF 2.5-10	Z7.280.7027.0 20	
6. Cover w. warning symbol over 4 blocks		ADC 1 YELLOW	04.344.0153.8 10
7. Test plug		WK 2.5 ST 2/2.3	Z5.553.2921.0 10
8. Screw driver, uninsulated		DIN 5264 B 0.6 x 3.5	06.502.4000.0 5
9. Marking accessories		also see page 21/22	
*CSA pending LR 12722			

56.303.7053.9		
56.303.7053.5		
56.303.7153.5		
56.303.7153.9		
56.303.8153.9		I = 1 A U = 1000 V
56.303.8253.5		I = 1 A U = 1000 V
56.303.7953.5		I = 1 A U = 1000 V
56.303.8353.5		I = 1 A U = 1000 V
56.303.7453.9		R = 2.2 KΩ P = 0.35 W U = 24 V DC
56.303.7253.5		R = 2.2 KΩ P = 0.35 W U = 24 V DC
56.303.7353.5		R = 680 KΩ P = 0.25 W U = 100-500 V

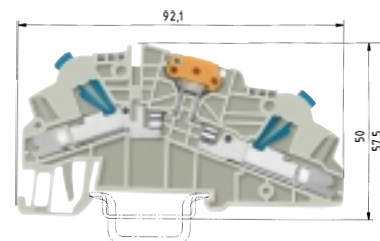
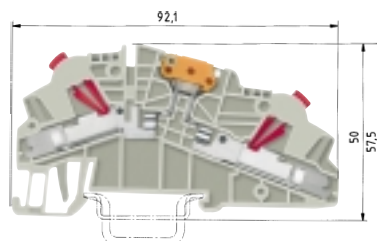

The disconnect knife of the knife edge disconnect block is swung in and out via a hinge.

The conspicuous color of the disconnect lever indicates the open position.

The blocks can be fixed both in the open and the closed position.

WKC 1 TKM/35

fine stranded stranded V A
 0.2 – 1 mm² 0.2 – 1 mm² 800 V/8kV/3 13.5
 No. 24-18 AWG
 No. 24-18 AWG*
 5 mm 1 mm²
 UL, CSA pending

WKC 2.5 TKM/35

fine stranded stranded V A
 1 – 2.5 mm² 1 – 2.5 mm² 800 V/8kV/3 20
 No. 16-14 AWG
 No. 16-14 AWG*
 6 mm 2.5 mm²
 UL, CSA pending

EN 60 947-7-1

UL ratings

CSA ratings

Width

Rated cross section

Approvals

		Type	Part no.	Std. pack	Type	Part no.	Std. pack
Knife edge disconnect block	gray	WKC 1 TKM/35	56.301.2053.0	50	WKC 2.5 TKM/35	56.303.2053.0	50
Knife edge disconnect block	blue	WKC 1 TKM/35 BLUE	56.301.2053.6	50	WKC 2.5 TKM/35 BLUE	56.303.2053.6	50
Accessories							
1. Mounting rail 35, 7.5 mm high	L = 2 m	35 x 27 x 7.5 EN 50022	98.300.0000.0	1	35 x 27 x 7.5 EN 50022	98.300.0000.0	1
Mounting rail 35, 15 mm high	L = 2 m	35 x 24 x 15 EN 50022	98.360.0000.0	1	35 x 24 x 15 EN 50022	98.360.0000.0	1
2. End brackets for TS 35	8 mm wide	9708/2 S 35	Z5.522.8553.0	100	9708/2 S 35	Z5.522.8553.0	100
3. End plate	gray	APC 1.5-2.5 D1./TK.	07.312.5253.0	10	APC 1.5-2.5 D1./TK.	07.312.5253.0	10
	blue	APC 1.5-2.5 D1./TK.BLUE	07.312.5253.6	10	APC 1.5-2.5 D1./TK.BLUE	07.312.5253.6	10
	green						
4. Partition plate	gray	TWC 1.5-2.5 D1.	07.312.5353.0	10	TWC 1.5-2.5 D1.	07.312.5353.0	10
	blue	TWC 1.5-2.5 D1. BLUE	07.312.5353.6	10	TWC 1.5-2.5 D1. BLUE	07.312.5353.6	10
5. Cross connector, insulated	2pole	IVB WKF 2.5-2	Z7.280.6227.0	10	IVB WKF 4-2	Z7.261.1227.0	10
	3pole	IVB WKF 2.5-3	Z7.280.6327.0	10	IVB WKF 4-3	Z7.261.1327.0	10
	4pole	IVB WKF 2.5-4	Z7.280.6427.0	10	IVB WKF 4-4	Z7.261.1427.0	10
	5pole	IVB WKF 2.5-5	Z7.280.6527.0	10	IVB WKF 4-5	Z7.261.1527.0	10
	6pole	IVB WKF 2.5-6	Z7.280.6627.0	10	IVB WKF 4-6	Z7.261.1627.0	10
	7pole	IVB WKF 2.5-7	Z7.280.6727.0	20	IVB WKF 4-7	Z7.261.1727.0	20
	8pole	IVB WKF 2.5-8	Z7.280.6827.0	20	IVB WKF 4-8	Z7.261.1827.0	20
9pole		IVB WKF 2.5-9	Z7.280.6927.0	20	IVB WKF 4-9	Z7.261.1927.0	20
	10pole	IVB WKF 2.5-10	Z7.280.7027.0	20	IVB WKF 4-10	Z7.261.2027.0	20
6. Cover w. warning symbol over 4 blocks		ADC 1 YELLOW	04.344.0153.8	10	ADC 2.5 YELLOW	04.344.0353.8	10
7. Test plug		WK 2.5 ST 2/2.3	Z5.553.2921.0	10	WK 2.5 ST 2/2.3	Z5.553.2921.0	10
8. Screw driver, uninsulated		DIN 5264 B 0.6 x 3.5	06.502.4000.0	5	DIN 5264 B 0.6 x 3.5	06.502.4000.0	5
9. Marking accessories		also see page 21/22			also see page 21/22		
*CSA pending LR 12722							

IDC Disconnect Block Type WKC

Fuse plug:

Nominal voltage: 250 V~
 Nominal current: – 6.3 A for single blocks
 – 4 A for blocks directly snapped together
 Max. power loss of the fuse insert: 1.6 W
 Indicator (24 V): signal color red
 current intake: 10.3 mA
 Indicator (220 V): signal color red
 current intake: 0.3 mA

*) The power load is determined by the built-in fuse. The voltage range is determined by the built-in LED.

EN 60 947-7-1

UL ratings

CSA ratings

Width Rated cross section

Approvals

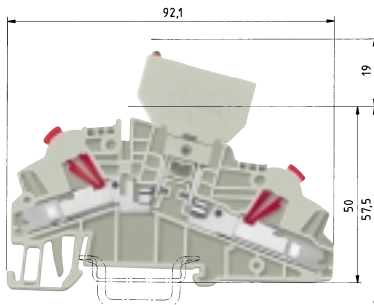

**WKC 1 TKG/35
with fuse holder**

fine stranded	stranded	V	A
0.2 – 1 mm ²	0.2 – 1 mm ²	800 V/8kV/3	*
No. 24-18 AWG			
No. 24-18 AWG**			
5 mm		1 mm ²	
UL, CSA pending			

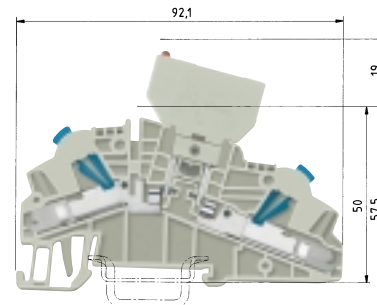

**WKC 2.5 TKG/35
with fuse holder**

fine stranded	stranded	V	A
1 – 2.5 mm ²	1 – 2.5 mm ²	800 V/8kV/3	*
No. 16-14 AWG			
No. 16-14 AWG**			
6 mm		2.5 mm ²	
UL, CSA pending			

		Type	Part no.	Std. pack	Type	Part no.	Std. pack
Disconnect block	gray	WKC 1 TKG/35	56.301.4053.0	50	WKC 2.5 TKG/35	56.303.4053.0	50
Fuse holder for fuse 5 x 20	gray	Si ST	Z1.299.4053.0	10	Si ST	Z1.299.4053.0	10
Fuse holder with indicator (24 V)	gray	Si ST LED	Z1.299.4153.0	10	Si ST LED	Z1.299.4153.0	10
Fuse holder with indicator (220 V)	gray	Si ST GL	Z1.299.4253.0	10	Si ST GL	Z1.299.4253.0	10
Accessories							
1. Mounting rail 35, 7.5 mm high	L = 2 m	35 x 27 x 7.5 EN 50022	98.300.0000.0	1	35 x 27 x 7.5 EN 50022	98.300.0000.0	1
Mounting rail 35, 15 mm high	L = 2 m	35 x 24 x 15 EN 50022	98.360.0000.0	1	35 x 24 x 15 EN 50022	98.360.0000.0	1
2. End brackets for TS 35	8 mm wide	9708/2 S 35	Z5.522.8553.0	100	9708/2 S 35	Z5.522.8553.0	100
3. End plate	gray	APC 1.5-2.5 D1./TK.	07.312.5253.0	10	APC 1.5-2.5 D1./TK.	07.312.5253.0	10
	blue				APC 1.5-2.5 D1./TK.BLUE	07.312.5253.6	10
	green						
4. Partition plate	gray	TWC 1.5-2.5 D1.	07.312.5353.0	10	TWC 1.5-2.5 D1.	07.312.5353.0	10
	blue						
5. Cross connector,	2pole	IVB WKF 2.5-2	Z7.280.6227.0	10	IVB WKF 4-2	Z7.261.1227.0	10
insulated	3pole	IVB WKF 2.5-3	Z7.280.6327.0	10	IVB WKF 4-3	Z7.261.1327.0	10
	4pole	IVB WKF 2.5-4	Z7.280.6427.0	10	IVB WKF 4-4	Z7.261.1427.0	10
	5pole	IVB WKF 2.5-5	Z7.280.6527.0	10	IVB WKF 4-5	Z7.261.1527.0	10
	6pole	IVB WKF 2.5-6	Z7.280.6627.0	10	IVB WKF 4-6	Z7.261.1627.0	10
	7pole	IVB WKF 2.5-7	Z7.280.6727.0	20	IVB WKF 4-7	Z7.261.1727.0	20
	8pole	IVB WKF 2.5-8	Z7.280.6827.0	20	IVB WKF 4-8	Z7.261.1827.0	20
	9pole	IVB WKF 2.5-9	Z7.280.6927.0	20	IVB WKF 4-9	Z7.261.1927.0	20
	10pole	IVB WKF 2.5-10	Z7.280.7027.0	20	IVB WKF 4-10	Z7.261.2027.0	20
6. Cover w. warning symbol over 4 blocks		ADC 1 YELLOW	04.344.0153.8	10	ADC 2.5 YELLOW	04.344.0353.8	10
7. Test plug		WK 2.5 ST 2/2.3	Z5.553.2921.0	10	WK 2.5 ST 2/2.3	Z5.553.2921.0	10
8. Screw driver, uninsulated		DIN 5264 B 0.6 x 3.5	06.502.4000.0	5	DIN 5264 B 0.6 x 3.5	06.502.4000.0	5
9. Marking accessories		also see page 21/22			also see page 21/22		
**CSA pending LR 12722							

IDC Disconnect Block Type WKC

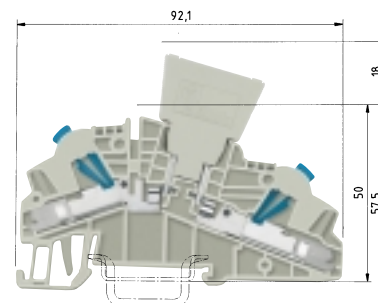
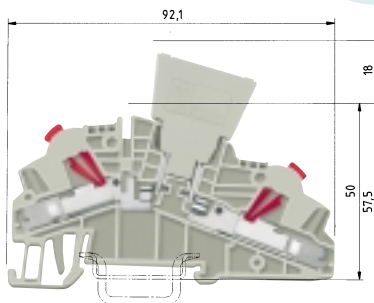

***) The power load is determined by the inserted part
 Periodic peak voltage 1000 V
 Direction of the diode: Anode Cathode
 Cathode Anode

WKC 1 TKG/35 with diode plug

WKC 2.5 TKG/35 with diode plug

fine stranded stranded V A
 0.2 – 1 mm² 0.2 – 1 mm² 800 V/8kV/3 **
 No. 24-18 AWG
 No. 24-18 AWG*
 5 mm 1 mm²
 UL, CSA pending

fine stranded stranded V A
 1 – 2.5 mm² 1 – 2.5 mm² 800 V/8kV/3 **
 No. 16-14 AWG
 No. 16-14 AWG*
 6 mm 2.5 mm²
 UL, CSA pending

EN 60 947-7-1

UL ratings

CSA ratings

Width Rated cross section

Approvals

			Type	Part no.	Std. pack	Type	Part no.	Std. pack
Disconnect block		gray	WKC 1 TKG/35	56.301.4053.0	50	WKC 2.5 TKG/35	56.303.4053.0	50
Diode plug – empty	J _{max} = 10 A	gray	DIST ...	Z1.299.3053.0	10	DIST ...	Z1.299.3053.0	10
Diode plug – diode	J _{max} = 1 A	gray	DIST-1 N 4007-1 ¹⁾	Z1.299.3153.0	10	DIST-1 N 4007-1 ¹⁾	Z1.299.3153.0	10
Diode plug – diode	J _{max} = 1 A	gray	DIST-1 N 4007-2 ²⁾	Z1.299.3353.0	10	DIST-1 N 4007-2 ²⁾	Z1.299.3353.0	10
Diode plug with jumper	J _{max} = 10 A	gray	DIST-D	Z1.299.3253.0	10	DIST-D	Z1.299.3253.0	10
Accessories								
1. Mounting rail 35, 7.5 mm high	L = 2 m		35 x 27 x 7.5 EN 50022	98.300.0000.0	1	35 x 27 x 7.5 EN 50022	98.300.0000.0	1
Mounting rail 35, 15 mm high	L = 2 m		35 x 24 x 15 EN 50022	98.360.0000.0	1	35 x 24 x 15 EN 50022	98.360.0000.0	1
2. End brackets for TS 35	8 mm wide		9708/2 S 35	Z5.522.8553.0	100	9708/2 S 35	Z5.522.8553.0	100
3. End plate		gray	APC 1.5-2.5 D1./TK.	07.312.5253.0	10	APC 1.5-2.5 D1./TK.	07.312.5253.0	10
		blue						
		green						
4. Partition plate		gray	TWC 1.5-2.5 D1.	07.312.5353.0	10	TWC 1.5-2.5 D1.	07.312.5353.0	10
		blue						
5. Cross connector,	2pole		IVB WKF 2.5-2	Z7.280.6227.0	10	IVB WKF 4-2	Z7.261.1227.0	10
insulated	3pole		IVB WKF 2.5-3	Z7.280.6327.0	10	IVB WKF 4-3	Z7.261.1327.0	10
	4pole		IVB WKF 2.5-4	Z7.280.6427.0	10	IVB WKF 4-4	Z7.261.1427.0	10
	5pole		IVB WKF 2.5-5	Z7.280.6527.0	10	IVB WKF 4-5	Z7.261.1527.0	10
	6pole		IVB WKF 2.5-6	Z7.280.6627.0	10	IVB WKF 4-6	Z7.261.1627.0	10
	7pole		IVB WKF 2.5-7	Z7.280.6727.0	20	IVB WKF 4-7	Z7.261.1727.0	20
	8pole		IVB WKF 2.5-8	Z7.280.6827.0	20	IVB WKF 4-8	Z7.261.1827.0	20
	9pole		IVB WKF 2.5-9	Z7.280.6927.0	20	IVB WKF 4-9	Z7.261.1927.0	20
	10pole		IVB WKF 2.5-10	Z7.280.7027.0	20	IVB WKF 4-10	Z7.261.2027.0	20
6. Cover w. warning symbol over 4 blocks			ADC 1 YELLOW	04.344.0153.8	10	ADC 2.5 YELLOW	04.344.0353.8	10
7. Test plug			WK 2.5 ST 2/2.3	Z5.553.2921.0	10	WK 2.5 ST 2/2.3	Z5.553.2921.0	10
8. Screw driver, uninsulated			DIN 5264 B 0.6 x 3.5	06.502.4000.0	5	DIN 5264 B 0.6 x 3.5	06.502.4000.0	5
9. Marking accessories			also see page 21/22			also see page 21/22		
*CSA pending LR 12722								

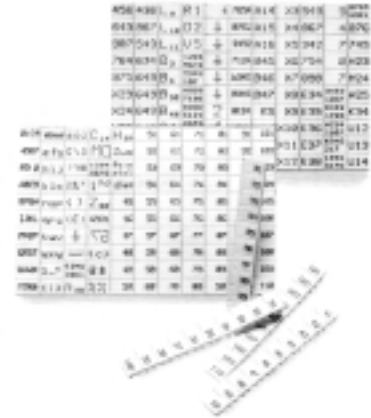
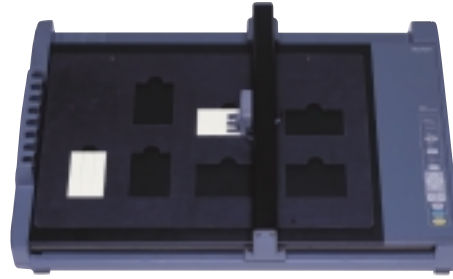

Material: Polyamide 6.6
Color: black figures on white background

taris IDC DIN rail terminal blocks, type WKC, can take in marking tags on both sides on top of the block in a three-chamber slot.

- Marking strips** made from Polyamide 6.6, suitable for 10 blocks in a row, marked and unmarked.
Marking 1-10, 11-20 etc. up to 991-999.
Type 9705 A/5/10 (5 mm spacing) for terminal blocks of type WKC 1.
Type 9705 A/6/10 (6 mm spacing) for terminal blocks of type WKC 2.5.
- Tear-off marking strips** are made from white Polyamide 6.6 and feature 10 marking tags, marked and unmarked. With only 11 stock positions, this marking system reduces the time needed to pick and attach tags and keeps inventory low for additional cost savings.
Type 9704 A. (see master catalog page 1/104)
- Single marking tag**, made from white Polyamide 6.6, marked and unmarked.
Type 9705 A.
- Marking plates** made from Polyamide 6.6 consisting of 11 marking strips.
Type 9705 A/5/10 (5 mm spacing) for terminal blocks type WKC 1.
Type 9705 A/6/10 (6 mm spacing) for terminal blocks type WKC 2.5.

Marcom 2000 Custom Marking Tag System

Description:	Description:	Part no.
The Wieland Marcom 2000 is a plotter system that uses Wieland's Windows® based software package to interface with a PC, allowing custom printing on standard Wieland marking tags. These standard marking tags provide circuit identification for Wieland DIN rail mount terminal blocks, rectangular multipole connectors and WEB/WEG electronic housings.	Plotter	IP220-WI*
	Software	MARCOM2000 Software* **
	Manual	MARCOM2000 Manual* **
	Templates:	
	Multicard Template	PT ALL TAGS* **
	9705 AL/5/10/6	PT AL-5-10* **
	9705 A/5/10/11	PT A-5-10* **
	9705 AL/6/10/6	PT AL-6-10* **
	9705 A/6/10/11	PT A-6-10* **
Resolution:	0.025mm	
Accuracy:	+/-0.1mm	
Power Supply:	50/60 hertz	
	180-264V, 90-132V	
	Automatic switch over from	
	110V to 230V	
Power Rating:	About 0.3A for 220V	
Approvals:	UL-UL478 (REV.4)	
	CSA-22.2 No. 220 and	
	VDE EN 60 950	
Interference:	FCC Class B	
	FCC Part 15 and VDE Class B	
Dimensions:	620mm x 425mm x 106.5mm	
Weight:	6.4kg	
Interfaces:	RS-232C and parallel (Centronics)	
Software:		
Supports Windows 3.1®, Windows 95®, or Windows NT®		
(plotter does not support NT, only the software supports NT).		
Requirements:		
486 IBM compatible PC with 4MB of RAM		
(8MB recommended), 5 Megabytes of free hard drive space.		
	Marker Cards:	
	9705 A/5/10/11	Z4.242.5053.0 110 tags per card
	9705 AL/5/10/6	Z4.242.5153.0 60 tags per card
	9705 A/6/10/11	Z4.242.6053.0 110 tags per card
	9705 AL/6/10/6	Z4.242.6153.0 60 tags per card
	9705 A/6.7/12/7	Z4.242.6753.0* 84 tags per card
	9705 AL/6.7/12/7	Z4.242.6853.0* 36 tags per card
	9705 A/8/10/7	Z4.242.8053.0*
		* must use multi-card template.
	Pens & Accessories:	
	Pen point 0.25mm	759 025*
	Pen point 0.18mm (recommended)	759 018
	Pen Adaptor	75PL07H2*
	Ink, Black	485 23SAR-9*
	Pen Cleanser	05.579.3301.0
	Container for Cleanser	05.579.3302.0
	Kits:	
	Turnkey Kit	MARCOM2000 KIT1 (includes *)
	Accessories Kit	MARCOM2000 KIT2 (includes **)

Marking Strips and Marking Plates

taris



Marking facilities for terminal blocks

1 mm²/5 mm Width

2.5 mm²/6 mm Width

Type	Part no.	Std. pack	Type	Part no.	Std. pack	Type	Part no.	Std. pack
Partition plate with marking facilities for terminal blocks (color: gray)			Marking strips, unmarked			Marking strips, unmarked		
			9705 A/5/10	04.242.5053.0	25	9705 A/6/10	04.242.6053.0	25
			Marking strips, marked			Marking strips, marked		
	Z7.311.7055.0	10	9705 A/5/10 B 1 - 10	04.845.0153.0	25	9705 A/6/10 B 1 - 10	04.846.0153.0	25
			11 - 20	04.845.0253.0	25	11 - 20	04.846.0253.0	25
			21 - 30	04.845.0353.0	25	21 - 30	04.846.0353.0	25
			31 - 40	04.845.0453.0	25	31 - 40	04.846.0453.0	25
End brackets with marking facilities for terminal blocks (color: black)			41 - 50	04.845.0553.0	25	41 - 50	04.846.0553.0	25
			51 - 60	04.845.0653.0	25	51 - 60	04.846.0653.0	25
			61 - 70	04.845.0753.0	25	61 - 70	04.846.0753.0	25
			71 - 80	04.845.0853.0	25	71 - 80	04.846.0853.0	25
	69.920.0553.0	10	81 - 90	04.845.0953.0	25	81 - 90	04.846.0953.0	25
			91 - 100	04.845.1053.0	25	91 - 100	04.846.1053.0	25
Marking card in perforated sheets (1 sheet = 100 individual tags)			⊕ (10 x)	04.855.0053.0	25	⊕ (10 x)	04.856.0053.0	25
			⊖ (10 x)	04.855.0153.0	25	⊖ (10 x)	04.856.0153.0	25
			+ (10 x)	04.855.0253.0	25	+ (10 x)	04.856.0253.0	25
			- (10 x)	04.855.0353.0	25	- (10 x)	04.856.0353.0	25
			L1 (10 x)	04.855.0453.0	25	L1 (10 x)	04.856.0453.0	25
	04.019.0289.0	10	L2 (10 x)	04.855.0553.0	25	L2 (10 x)	04.856.0553.0	25
			L3 (10 x)	04.855.0653.0	25	L3 (10 x)	04.856.0653.0	25
			PE (10 x)	04.855.0753.0	25	PE (10 x)	04.856.0753.0	25
			SL (10 x)	04.855.3153.0	25	SL (10 x)	04.856.3153.0	25
			N (10 x)	04.855.3253.0	25	N (10 x)	04.856.3253.0	25
			F1 (10 x)	04.855.0953.0	25	F1 (10 x)	04.856.0953.0	25
			F2 (10 x)	04.855.1053.0	25	F2 (10 x)	04.856.1053.0	25
			L1, L2, L3, N, PE (2 x)	04.855.0853.0	25	L1, L2, L3, N, PE (2 x)	04.856.0853.0	25
			Marking plates, unmarked			Marking plates, unmarked		
			9705 A/5/10/11	Z4.242.5053.0	10	9705 A/6/10/11	Z4.242.6053.0	10
			custom marking upon request			custom marking upon request		

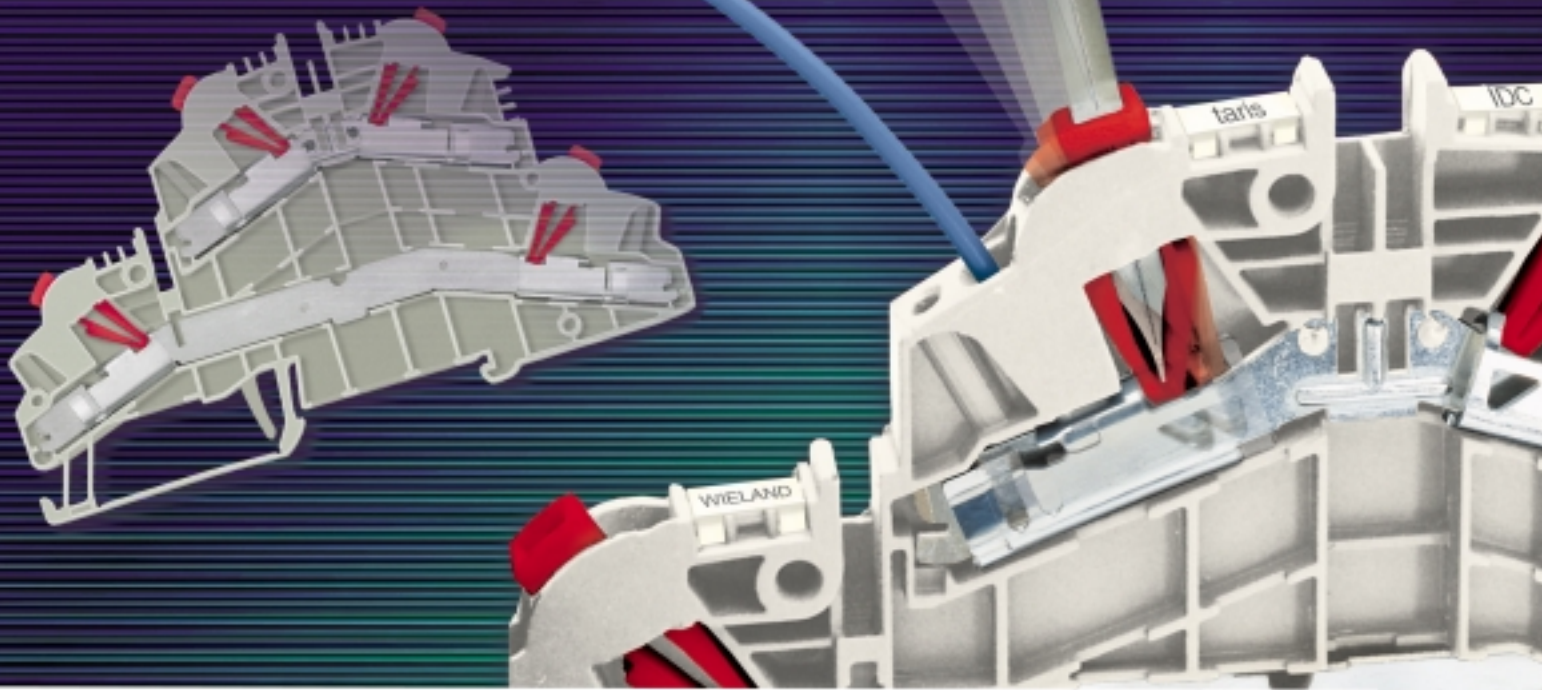

taris: The Two-Second Connection.

Advanced IDC Technology From Wieland

Introducing Wieland's new *taris* IDC technology in the first comprehensive family of DIN rail terminal blocks:

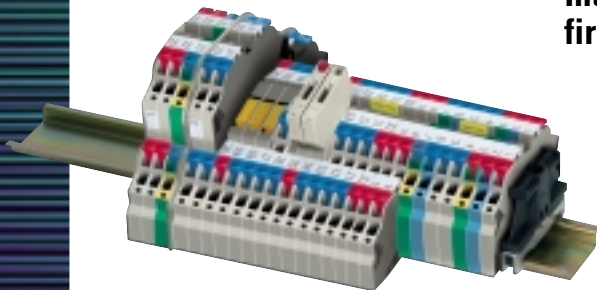

The complete *taris* IDC Series includes the following terminal block versions in 5mm and 6mm widths:

- Feed-through
- Ground
- Disconnect
- Fuse
- Arc suppression
- Reverse polarity protection
- 1-in, 2-out feed-through
- 1-in, 2-out ground
- Double-tier feed-through
- Double-tier ground
- Voltage indication

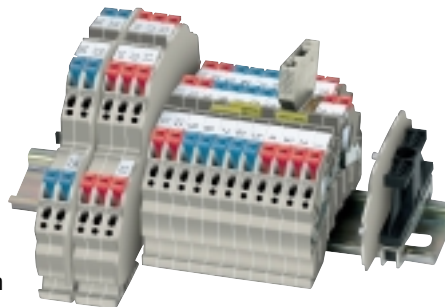

- Advanced *taris* IDC (insulation displacement contact) technology makes wiring installation fast and easy – no wire stripping or preparation required
- The *taris* Series' superior contact design moves the clamp to the wire to ensure a proper connection even when the wire length is maxed out
- At just 5mm and 6mm wide, the *taris* Series includes the industry's narrowest IDC blocks capable of accepting 14 AWG
- Designed to Wieland's superior quality standards, the *taris* IDC Series offers a UL 94-V0 non-flammability rating, built-in test points, jumpering and marking facilities at each termination point

For more information on *taris* IDC, call:

1-800-wieland
(1-800-943-5263)

or visit www.wielandinc.com



***taris* Advanced IDC: the two-second connection**

- Superior insulation displacement contact design
- No wire stripping or preparation
- Reduces installation time by 50-60%
- No special tools required
- UL 94-V0 non-flammability rating
- Built-in test points, jumpering and marking facilities at each termination point
- At just 5mm and 6mm wide-the industry's narrowest IDC blocks capable of accepting 14 AWG



wieland

...your connection to the future™

U.S.A.

49 International Road
Burgaw, NC 28425
Phone (910) 259-5050
Fax (910) 259-3691

Canada

2889 Brighton Road
Oakville, Ontario L6H 6C9
Phone (905) 829-8414
Fax (905) 829-8413

On the Internet

www.wielandinc.com

taris

IDC terminal blocks