

# LMS202

## 5V Single Supply TIA/EIA-232 Dual Transceivers

### General Description

The LMS202 features two transmitters and two receivers for RS-232 communication. It has a DC-to-DC converter that permits the device to operate with only a single +5V power supply. The on-chip DC-to-DC converter which utilizes four external 0.1µF capacitors to generate dual internal power supplies for RS-232 compatible output levels.

The device meet EIA/TIA-232E and CCITT V.28 specifications up to 230kbits/sec. The LMS202 is available in a 16 pin narrow and Wide SOIC package.

### Features

- Single +5V power supply
- 230 kbps data rate
- On-board DC-to-DC converter
- 0.1µF charge pump capacitors
- Drop-in replacement to Maxim's MAX202

### Applications

- POS equipment (Bar code reader)
- Hand-held equipment
- General purpose RS-232 communication

### Connection Diagram and Typical Circuit

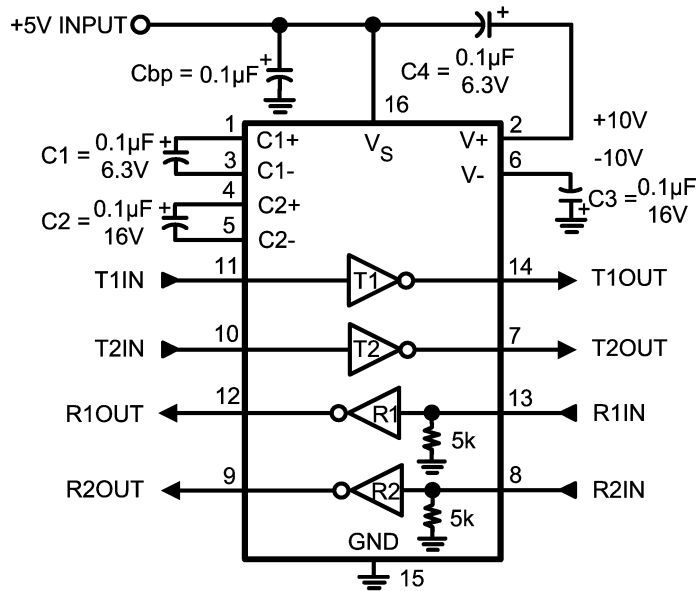

20062901

## Pin Descriptions

Pin Number	Pin Name	Pin Function
1, 3	C1+, C1-	External capacitor connection pins. Recommended external capacitor C1 = 0.1 $\mu$ F (6.3V)
2	V+	Positive supply for TIA/EIA-232E drivers. Recommended external capacitor C4 = 0.1 $\mu$ F (6.3V)
4, 5	C2+, C2-	External capacitor connection pins. Recommended external capacitor C2 = 0.1 $\mu$ F (16V)
6	V-	Negative supply for TIA/EIA-232E drivers. Recommended external capacitor C3 = 0.1 $\mu$ F (16V)
7, 14	T1out, T2out	Transmitter output pins conform to TIA/EIA-232E levels. The typical transmitter output swing is $\pm$ 8V when loaded 3k $\Omega$ load to ground. The open-circuit output voltage swings from (V+ - 0.6V) to V-
8,13	R1in, R2in	Receiver inputs accept TIA/EIA-232
9, 12	R1out and R2out	Receiver output pins are TTL/CMOS compatible
10, 11	Tin1, Tin2	Transmitter input pins are TTL/CMOS compatible. Inputs of transmitter do not have pull-up resistors. Connect all unused transmitter inputs to ground
15	GND	Ground pin
16	V <sub>S</sub>	Power supply pin for the device, +5V ( $\pm$ 10%)

## Ordering Information

Package	Part Number	Package Marking	Transport Media	NSC Drawing
16-Pin SOIC	LMS202CM	LMS202CM	48 Units/Rail	M16A
	LMS202CMX		2.5k Units Tape and Reel	
	LMS202IM	LMS202IM	48 Units/Rail	
	LMS202IMX		2.5k Units Tape and Reel	
16-Pin Wide SOIC	LMS202CMW	LMS202CMW	45 Units/Rail	M16B
	LMS202CMWX		1.0k Units Tape and Reel	
	LMS202IMW	LMS202IMW	45 Units/Rail	
	LMS202IMWX		1.0k Units Tape and Reel	

**Absolute Maximum Ratings** (Note 1)

If Military/Aerospace specified devices are required, please contact the National Semiconductor Sales Office/Distributors for availability and specifications.

$V_S$	-0.3V to 6V
$V_+$	$(V_S - 0.3V)$ to +14V
$V_-$	+0.3V to -14V
Driver Input Voltage, $T_{IN}$	-0.3V to $(V_+ + 0.3V)$
Receiver Input Voltage, $R_{IN}$	$\pm 30V$
Driver Output Voltage $T_O$	$(V_- - 0.3V)$ to $(V_+ + 0.3V)$
Receiver Output Voltage $R_O$	-0.3 to $(V_S + 0.3)$
Short Circuit Duration, $T_O$	Continuous
ESD Rating	
Human Body Model (Note 2)	2kV
Machine Model (Note 6)	200V
Soldering Information	

Infrared or Convection (20sec.)	235°C
Junction Temperature	150°C
Storage Temperature Range	-65°C to +150°C

**Operating Ratings**

Supply Voltage $V_S$	4.5V to 5.5V
Ambient Temperature Range, $T_A$	
Commercial (C)	0°C to +70°C
Industrial (I)	-40°C to +85°C
Package Thermal Resistance (Note 3)	
SO	71°C/W
WSO	55°C/W

**Electrical Characteristics**

Over recommended operating supply and temperature ranges unless otherwise specified  $C_1 = C_2 = C_3 = C_4 = C_{bp} = 0.1\mu F$

Symbol	Parameter	Conditions	Min (Note 5)	Typ	Max (Note 5)	Units
<b>DC Characteristics</b>						
$I_S$	Supply Current	No Load, $T_A = 25^\circ C$		1	7	mA
<b>Logic</b>						
$I_{INPUT}$	Input Leakage Current	$T_{IN} = 0V$ to $V_S$			$\pm 10$	$\mu A$
$V_{THL}$	Input Logic Theshold Low	$T_{IN}$			0.8	V
$V_{THH}$	Input Logic Theshold High	$T_{IN}$	2.0			V
$V_{OL}$	TTL/CMOS Output Voltage Low	$R_{OUT}, I_{OUT} = 3.2mA$			0.4	V
$V_{OH}$	TTL/CMOS Output Voltage High	$R_{OUT}, I_{OUT} = -1.0mA$	3.5	$V_S - 0.1$		V
<b>RS-232 Receiver Inputs</b>						
$V_{RI}$	Receiver Input Voltage Range		-30		+30	V
$V_{RTHL}$	Receiver Input Theshold Low	$V_S = 5V, T_A = 25^\circ C$	0.8	1.4		V
$V_{RTHH}$	Receiver Input Theshold High	$V_S = 5V, T_A = 25^\circ C$		2	2.4	V
$V_{HYST}$	Receiver Input Hysteresis	$V_S = 5V$	0.2	0.6	1.0	V
$R_I$	Receiver Input Resistance	$V_S = 5V, T_A = 25^\circ C$	3	5	7	k $\Omega$
<b>RS-232 Transmitter Outputs</b>						
$V_O$	Transmitter Output Voltage Swing	All transmitters loaded with 3k $\Omega$ to GND	$\pm 5$	$\pm 8$		V
$R_O$	Output Resistance	$V_S = V_+ = V_- = 0V,$ $V_O = \pm 2V$	300			$\Omega$
$I_{OS}$	Output Short Circuit Current			$\pm 11$	$\pm 60$	mA
<b>Timing Characteristics</b>						
DR	Maximum Data Rate	$C_L = 50pF$ to 1000pF, $R_L = 3k\Omega$ to 7k $\Omega$	230			kbps
$T_{RPLH}$ $T_{RPHL}$	Receiver Propagation Delay	$C_L = 150pF$		0.08	1	$\mu s$
$T_{DPLH}$ $T_{DPHL}$	Transmitter Propagation Delay	$R_L = 3k\Omega, C_L = 2500pF$ All transmitters loaded		2.4		$\mu s$

## Electrical Characteristics (Continued)

Over recommended operating supply and temperature ranges unless otherwise specified  $C1 = C2 = C3 = C4 = C_{bp} = 0.1\mu\text{F}$

Symbol	Parameter	Conditions	Min (Note 5)	Typ	Max (Note 5)	Units
$V_{SLEW}$	Transition Region Slew Rate	$T_A = 25^\circ\text{C}$ , $V_S = 5\text{V}$ $C_L = 50\text{pF}$ to $1000\text{pF}$ , $R_L = 3\text{k}\Omega$ to $7\text{k}\Omega$ Measured from $+3\text{V}$ to $-3\text{V}$ or vice versa	3	6	30	$\text{V}/\mu\text{s}$

**Note 1:** Absolute Maximum Ratings indicate limits beyond which damage to the device may occur. Operating Ratings indicate conditions for which the device is intended to be functional, but specific performance is not guaranteed. For guaranteed specifications and the test conditions, see the Electrical Characteristics.

**Note 2:** Human Body Model,  $1.5\text{k}\Omega$  in series with  $100\text{pF}$

**Note 3:** The maximum power dissipation is a function of  $T_{J(\text{MAX})}$ ,  $\theta_{JA}$ , and  $T_A$ . The maximum allowable power dissipation at any ambient temperature is  $P_D = (T_{J(\text{MAX})} - T_A) / \theta_{JA}$ . All numbers apply for packages soldered directly onto a PC board.

**Note 4:** Typical Values represent the most likely parametric norm.

**Note 5:** All limits are guaranteed by testing or statistical analysis

**Note 6:** Machine model,  $0\Omega$  in series with  $200\text{pF}$

## Typical Characteristics

Transmitter Output High Voltage vs. Load Capacitance

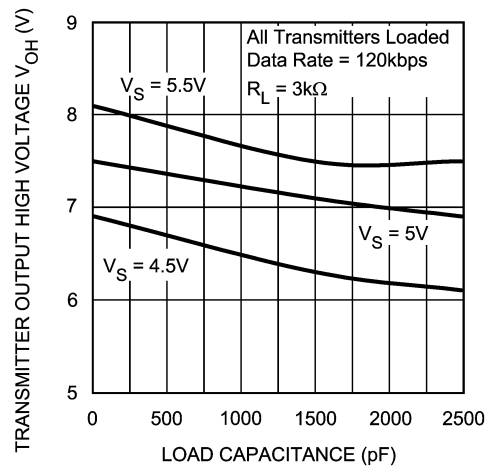

20062902

Transmitter Slew Rate vs. Load Capacitance

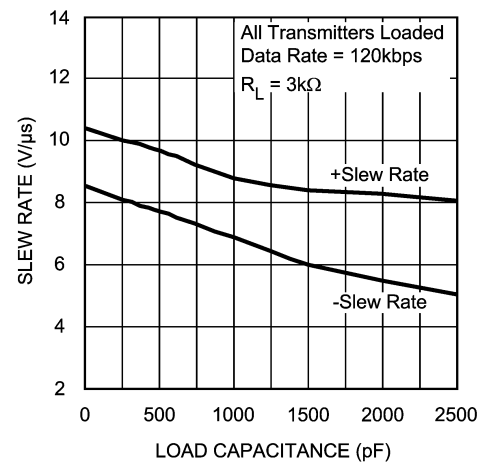

20062903

## Application Information

### CAPACITOR SELECTION

The recommended capacitors are  $0.1\mu\text{F}$ . However, larger capacitors for the charge pump may be used to minimize ripples on  $V_+$  and  $V_-$  pins.

### POWER SUPPLY DECOUPLING

In some applications that are sensitive to power supply noise from the charge pump, place a decoupling capacitor,  $C_{bp}$ , from  $V_S$  to GND. Use at least a  $0.1\mu\text{F}$  capacitor or the same size as the charge pump capacitors ( $C1 - C4$ ).

### CHARGED PUMP

The dual internal charged-pump provides the  $\pm 10\text{V}$  to the transmitters. Using capacitor  $C1$ , the charge pump converts  $+5\text{V}$  to  $+10\text{V}$  then stores the  $+10\text{V}$  in capacitor  $C3$ . The charge pump uses capacitor  $C2$  to invert the  $+10\text{V}$  to  $-10\text{V}$ . The  $-10\text{V}$  is then stored in capacitor  $C4$ .

**Physical Dimensions** inches (millimeters) unless otherwise noted

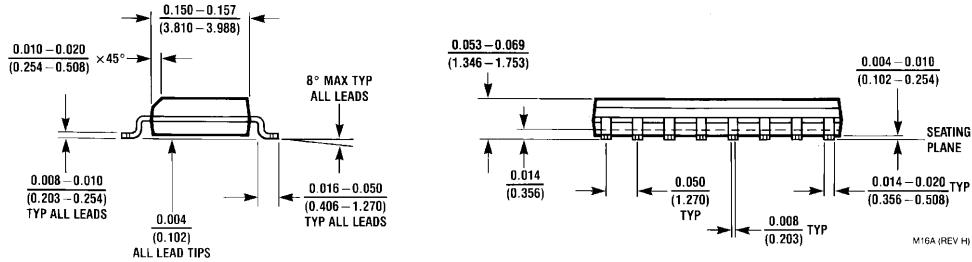
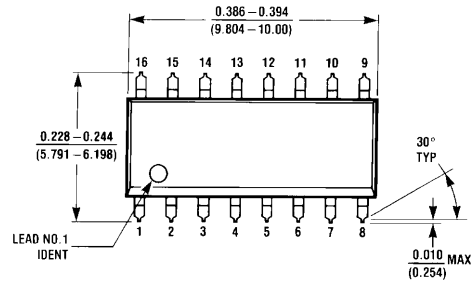

**16-Pin SOIC**  
**NS Package Number M16A**

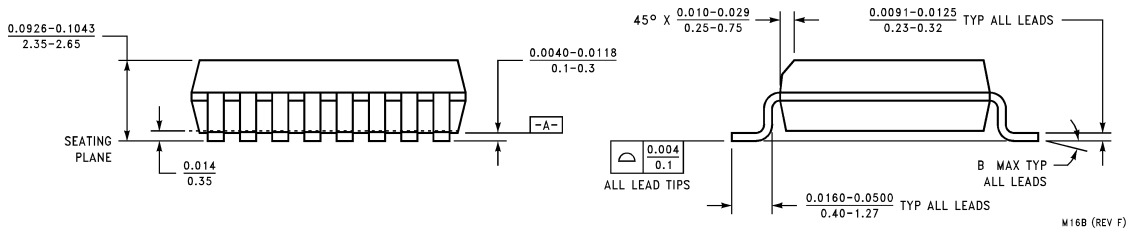
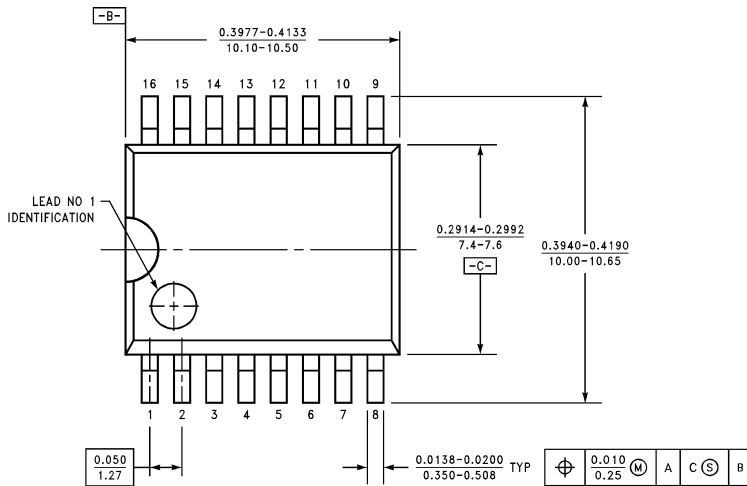

**16-Pin Wide SOIC**  
**NS Package Number M16B**

## Notes

### LIFE SUPPORT POLICY

NATIONAL'S PRODUCTS ARE NOT AUTHORIZED FOR USE AS CRITICAL COMPONENTS IN LIFE SUPPORT DEVICES OR SYSTEMS WITHOUT THE EXPRESS WRITTEN APPROVAL OF THE PRESIDENT AND GENERAL COUNSEL OF NATIONAL SEMICONDUCTOR CORPORATION. As used herein:

1. Life support devices or systems are devices or systems which, (a) are intended for surgical implant into the body, or (b) support or sustain life, and whose failure to perform when properly used in accordance with instructions for use provided in the labeling, can be reasonably expected to result in a significant injury to the user.
2. A critical component is any component of a life support device or system whose failure to perform can be reasonably expected to cause the failure of the life support device or system, or to affect its safety or effectiveness.



**National Semiconductor**  
**Americas Customer**  
**Support Center**  
Email: [new.feedback@nsc.com](mailto:new.feedback@nsc.com)  
Tel: 1-800-272-9959

[www.national.com](http://www.national.com)

**National Semiconductor**  
**Europe Customer Support Center**  
Fax: +49 (0) 180-530 85 86  
Email: [europa.support@nsc.com](mailto:europa.support@nsc.com)  
Deutsch Tel: +49 (0) 69 9508 6208  
English Tel: +44 (0) 870 24 0 2171  
Français Tel: +33 (0) 1 41 91 8790

**National Semiconductor**  
**Asia Pacific Customer**  
**Support Center**  
Fax: +65-6250 4466  
Email: [ap.support@nsc.com](mailto:ap.support@nsc.com)  
Tel: +65-6254 4466

**National Semiconductor**  
**Japan Customer Support Center**  
Fax: 81-3-5639-7507  
Email: [jpn.feedback@nsc.com](mailto:jpn.feedback@nsc.com)  
Tel: 81-3-5639-7560