

Wide input voltage Non-Isolated and Regulated Single Output

FEATURES

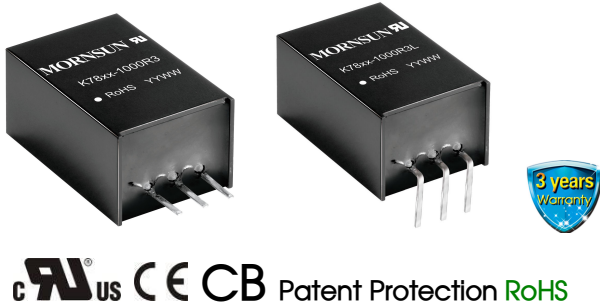

- High efficiency up to 96%
- No-load input current as low as 0.1mA
- Operating ambient temperature range -40°C to +85°C
- Support the negative output
- Output short-circuit protection
- Pin compatible with LM78xx series
- IEC60950, UL60950, EN62368 Approval

K78xx-1000R3(L) series are high efficiency switching regulators and ideal substitutes for LM78xx series three-terminal linear regulators. The converters feature high efficiency, low loss, short circuit protection, positive or negative output voltage, and there is no need for a heat sink. These products are widely used in applications such as industrial control, instrumentation and electric power.

Selection Guide

Certification	Part No.	Input Voltage (VDC) ^①	Output		Full Load Efficiency (%) Vin Min. / Vin Max.	Max. Capacitive Load (µF)
		Nominal (Range)	Voltage (VDC)	Current (mA) Max.		
UL/CE/CB	K7803-1000R3(L)	24 (6-36)	3.3	1000	90/81	680
	K7805-1000R3(L)	24 (8-36)	5	1000	93/86	680
		12 (8-27)	-5	-500	86/82	330
	K7809-1000R3(L)	24 (13-36)	9	1000	95/90	680
		K7812-1000R3(L)	24 (16-36)	12	1000	96/93
	12 (8-20)		-12	-300	89/88	330
	K7815-1000R3(L)	24 (20-36)	15	1000	96/94	680
		12 (8-18)	-15	-300	89/89	330

Note:

① For input voltage exceeding 30 VDC, an input capacitor of 22µF/50V is required;

② L-suffix: Add L-suffix for horizontal mount with 90 degree angled pins (K78xx-1000R3L).

Input Specifications

Item	Operating Conditions	Min.	Typ.	Max.	Unit
No-load Input Current	Positive output	--	0.1	1	mA
Reverse Polarity Input		Forbidden			
Input Filter		Capacitance filter			

Output Specifications

Item	Operating Conditions	Min.	Typ.	Max.	Unit	
Voltage Accuracy	Full load, input voltage range	K7803-1000R3(L)	--	±2	±4	%
		Others	--	±2	±3	
Linear Regulation	Full load, input voltage range	--	±0.2	±0.4		
Load Regulation	Nominal input, 10% -100% load	--	±0.4	±0.6		
Ripple & Noise*	20MHz bandwidth, nominal input, 20% -100% load	--	20	75	mVp-p	

Temperature Coefficient	Operating ambient temperature -40°C to +85°C	--	--	±0.03	%/°C
Transient Response Deviation	Nominal input voltage, 25% load step change	--	50	300	mV
Transient Recovery Time		--	0.1	1	ms
Short-circuit Protection	Nominal input	Continuous, self-recovery			

*Note: 1. The "parallel cable" method is used for Ripple and noise test, please refer to *DC-DC Converter Application Notes* for specific information;
2. With light loads at or below 20%, Ripple & Noise for 3.3/5V output parts increases to 100mVp-p max, and for 9V/12V/15V output parts to 2%Vo max.

General Specifications

Item	Operating Condition	Min.	Typ.	Max.	Unit	
Operating Temperature*	Derating if the temperature ≥71°C (see Fig. 1)	-40	--	85	°C	
Storage Temperature		-55	--	125		
Pin Soldering Resistance Temperature	Soldering time: 10 seconds	--	--	260		
Storage Humidity	Non-condensing	5	--	95	%RH	
Switching Frequency	100% load, input voltage range	K7803-1000R3(L)/K7805-1000R3(L)	420	520	620	kHz
		Other output	580	680	780	
MTBF	MIL-HDBK-217F@25°C	2000	--	--	k hours	

Note: *The K7803-2000 (L) part requires an input voltage ≥5V for operation at -40°C.

Mechanical Specifications

Case Material	Black plastic; flame-retardant and heat-resistant (UL94 V-0)	
Dimensions	K78xx-1000R3	11.50 x 9.00 x 17.50 mm
	K78xx-1000R3L	19.00 x 11.50 x 9.00 mm
Weight	3.8g (Typ.)	
Cooling Method	Free air convection	

Electromagnetic Compatibility (EMC)

Emissions	CE	CISPR32/EN55032	CLASS B (see Fig. 4-② for recommended circuit)	
	RE	CISPR32/EN55032	CLASS B (see Fig. 4-② for recommended circuit)	
Immunity	ESD	IEC/EN 61000-4-2	Contact ±4KV	perf. Criteria B
	RS	IEC/EN 61000-4-3	10V/m	perf. Criteria A
	EFT	IEC/EN 61000-4-4	±1KV (see Fig. 4-① for recommended circuit)	perf. Criteria B
	Surge	IEC/EN 61000-4-5	line to line ±1KV(see Fig. 4-① for recommended circuit)	perf. Criteria B
	CS	IEC/EN 61000-4-6	3Vr.m.s	perf. Criteria A

Typical Characteristic Curves

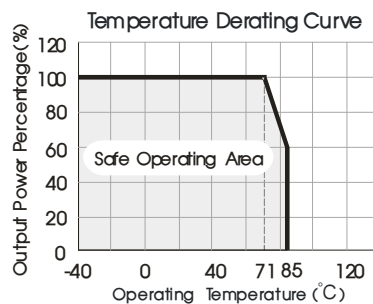
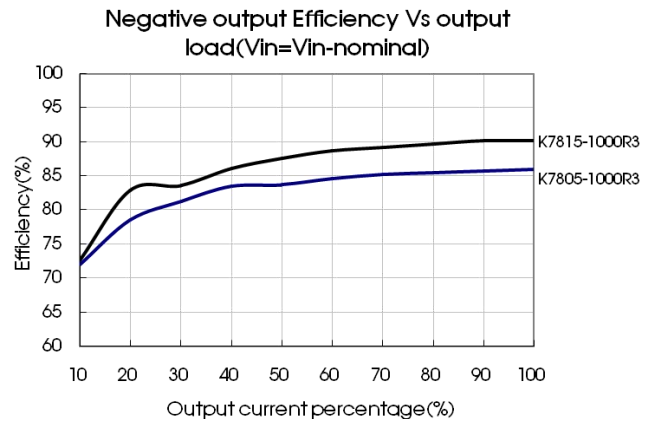
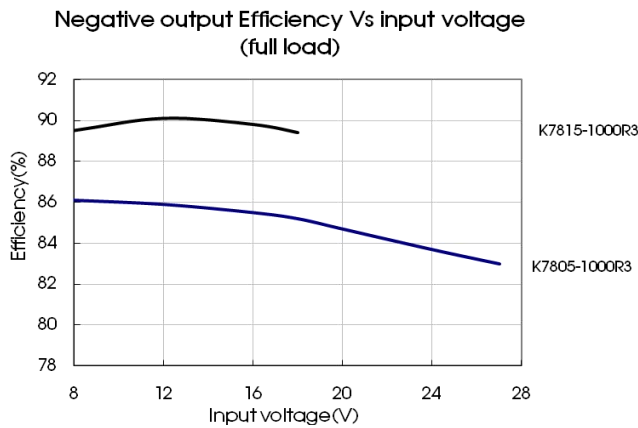
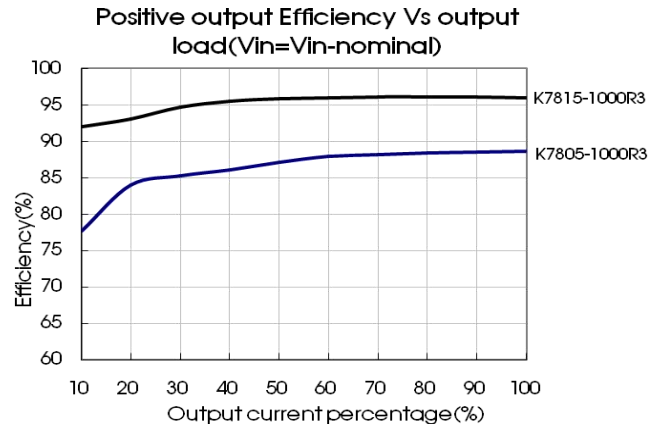
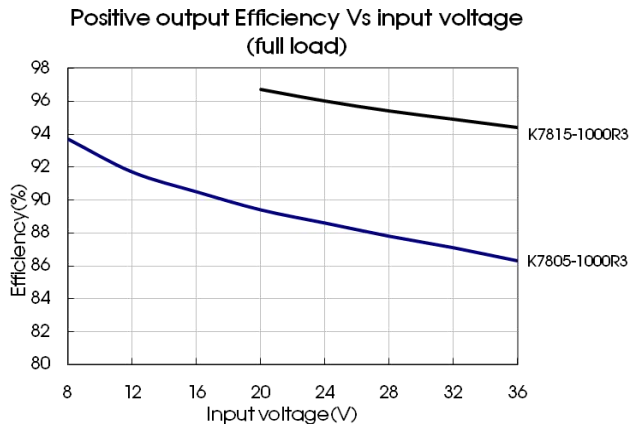

Fig. 1



Design Reference

1. Typical application

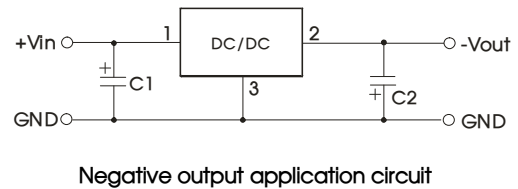
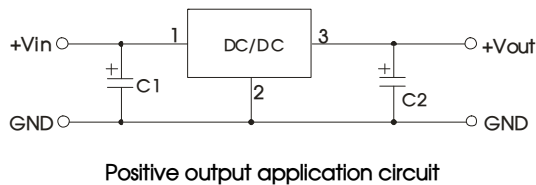

Fig. 2 Typical application circuit

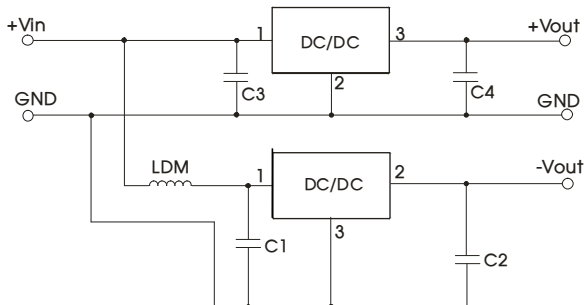

Fig. 3 Positive and Negative output application circuit

Part No.	C1/C3 (ceramic capacitor)	C2/C4 (ceramic capacitor)
K7803-1000R3(L)	10μF/50V	22μF/10V
K7805-1000R3(L)		22μF/10V
K7809-1000R3(L)		22μF/16V
K7812-1000R3(L)		22μF/25V
K7815-1000R3(L)		22μF/25V

- Note:
- The required capacitors C1 and C2 (C3 and C4) must be connected as close as possible to the terminals of the module;
 - Refer to Table 1 for C1 and C2 (C3 and C4) capacitor values. For certain applications, increased values for C2 and C4 and/or tantalum or low ESR electrolytic capacitors may also be used instead;
 - When using configurations as shown in figure 3, we recommended to add an inductor (LDM) with a value of up to 10μH which helps reducing mutual interference;
 - Converter cannot be used for hot swap and with output in parallel.

2. EMC compliance circuit

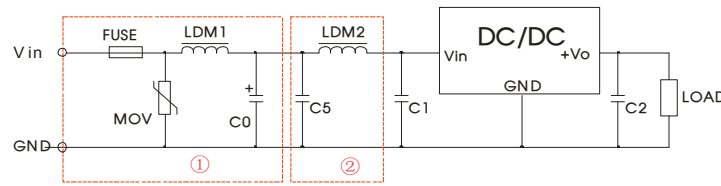

Fig. 4 EMC recommended circuit

FUSE	MOV	LDM1	C0	C1/C2	C5	LDM2
Select fuse value according to actual input current	S20K30	82μH	680μF /50V	Refer to table 1	4.7μF /50V	12μH

Note: Part ① in Fig. 4 shows EMS compliance filter and part ② filter for EMI compliance; depending on requirement both filters ① and ② can be used in series as shown.

3. For additional information please refer to DC-DC converter application notes on

www.mornsun-power.com

Dimensions and Recommended Layout

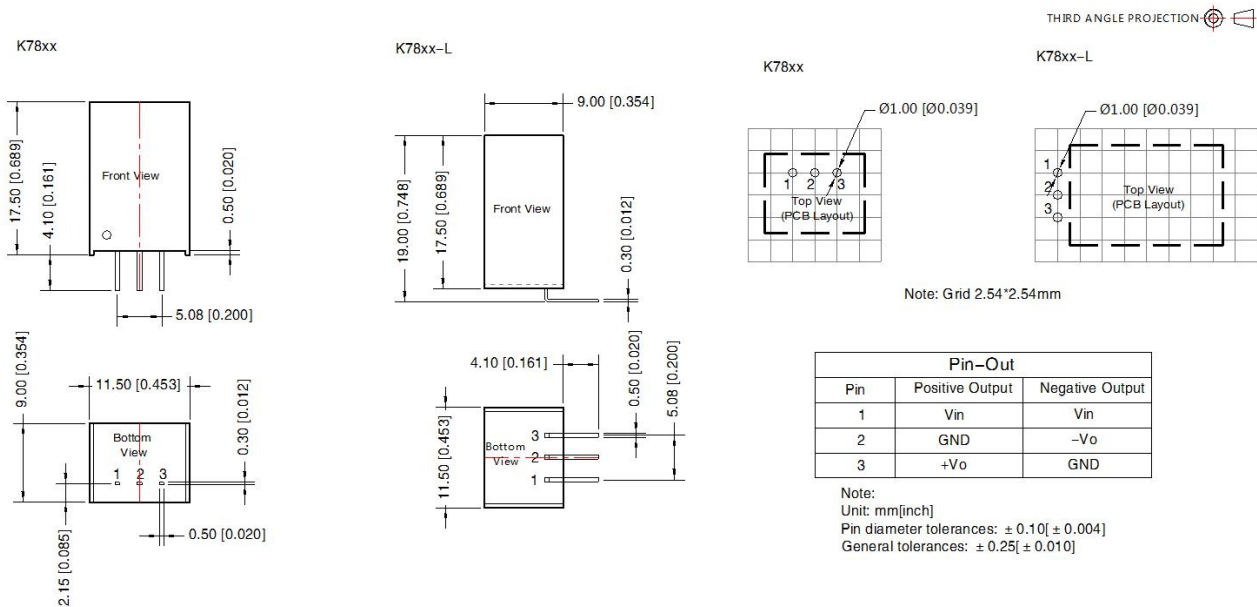

Notes:

- For additional information on Product Packaging please refer to www.mornsun-power.com. Packaging bag number: 58210021 (K78xx-1000R3), 58210027 (K78xx-1000R3L);
- The maximum capacitive load offered were tested at nominal input voltage and full load;
- Unless otherwise specified, parameters in this datasheet were measured under the conditions of Ta=25°C, humidity<75%RH with nominal input voltage and rated output load;
- All index testing methods in this datasheet are based on our company corporate standards;
- We can provide product customization service, please contact our technicians directly for specific information;
- Products are related to laws and regulations: see "Features" and "EMC";
- Our products shall be classified according to ISO14001 and related environmental laws and regulations, and shall be handled by qualified units.

MORNSUN Guangzhou Science & Technology Co., Ltd.

Address: No. 5, Kehui St. 1, Kehui Development Center, Science Ave., Guangzhou Science City, Huangpu District, Guangzhou, P. R. China
Tel: 86-20-38601850 Fax: 86-20-38601272 E-mail: info@mornsun.cn www.mornsun-power.com