

## SURFACE MOUNT SCHOTTKY BARRIER RECTIFIER

### Features

- ◆ The plastic package carries Underwriters Laboratory Flammability Classification 94V-0
- ◆ For surface mounted applications
- ◆ Metal silicon junction, majority carrier conduction
- ◆ Low power loss, high efficiency
- ◆ Built-in strain relief, ideal for automated placement
- ◆ High forward surge current capability
- ◆ High temperature soldering guaranteed:  
260 °C/10 seconds at terminals

SMAF

ROHS  
COMPLIANT

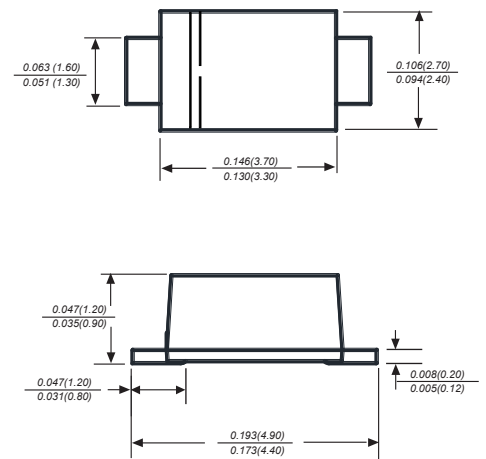

Dimensions in inches and (millimeters)

### Mechanical Data

Case: JEDEC SMAF molded plastic body

Terminals: Solderable per MIL-STD-750, Method 2026

Polarity: Color band denotes cathode end

Mounting Position: Any

Weight: 0.00095 ounce, 0.027 grams

### Maximum Ratings And Electrical Characteristics

Ratings at 25°C ambient temperature unless otherwise specified.

Single phase half-wave 60Hz, resistive or inductive load, for capacitive load current derate by 20%.

Parameter	SYMBOLS	MDD SS32F	MDD SS33F	MDD SS34F	MDD SS35F	MDD SS36F	MDD SS38F	MDD SS310F	MDD SS3150F	MDD SS3200F	UNITS	
Marking Code												
Maximum repetitive peak reverse voltage	$V_{RRM}$	20	30	40	50	60	80	100	150	200	V	
Maximum RMS voltage	$V_{RMS}$	14	21	28	35	42	56	70	105	140	V	
Maximum DC blocking voltage	$V_{DC}$	20	30	40	50	60	80	100	150	200	V	
Maximum average forward rectified current	$I_{AV}$	3.0									A	
Peak forward surge current 8.3ms single half sine-wave superimposed on rated load (JEDEC Method)	$I_{FSM}$	80									A	
Maximum instantaneous forward voltage at 3.0A	$V_F$	0.55		0.70			0.85		0.95		V	
Maximum DC reverse current at rated DC blocking voltage $T_A=25^\circ\text{C}$ $T_A=100^\circ\text{C}$	$I_R$	0.5			5.0			0.3		3.0		mA
Typical junction capacitance (NOTE 1)	$C_J$	250			180						pF	
Typical thermal resistance (NOTE 2)	$R_{\theta JA}$ $R_{\theta JC}$	70						18				°C/W
Operating junction temperature range	$T_J$	-55 to +125									°C	
Storage temperature range	$T_{STG}$	-55 to +150									°C	

Note: 1. Measured at 1MHz and applied reverse voltage of 4.0V D.C.

2. P.C.B. mounted with 2.0"x2.0" (5.0x5.0cm) copper pad areas

## Typical Characteristics

Fig.1 Forward Current Derating Curve

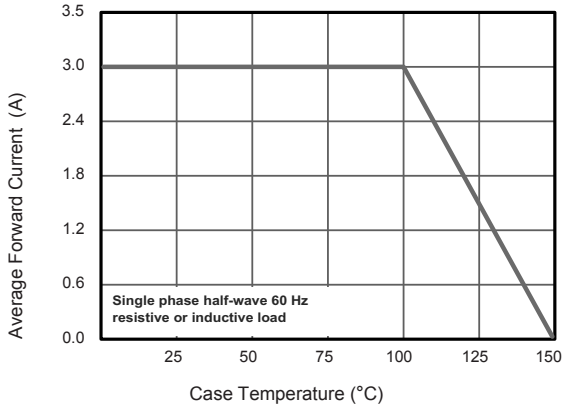

Fig.2 Typical Reverse Characteristics

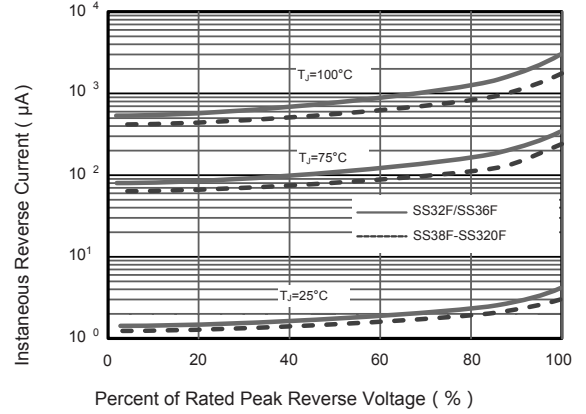

Fig.3 Typical Forward Characteristic

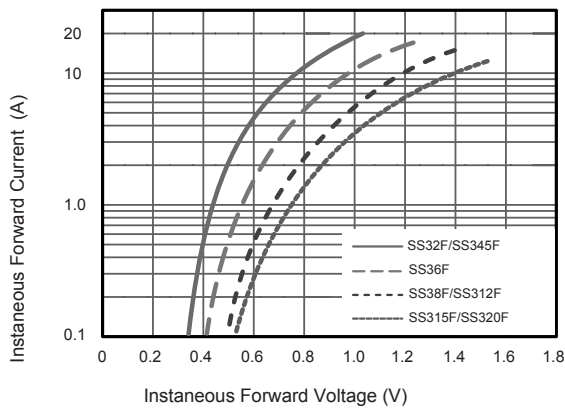

Fig.4 Typical Junction Capacitance

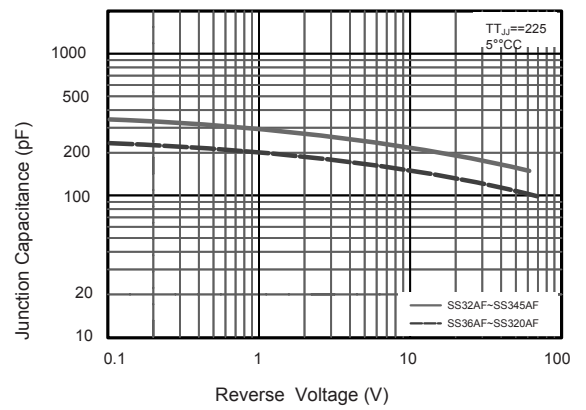

Fig.5 Maximum Non-Repetitive Peak Forward Surge Current

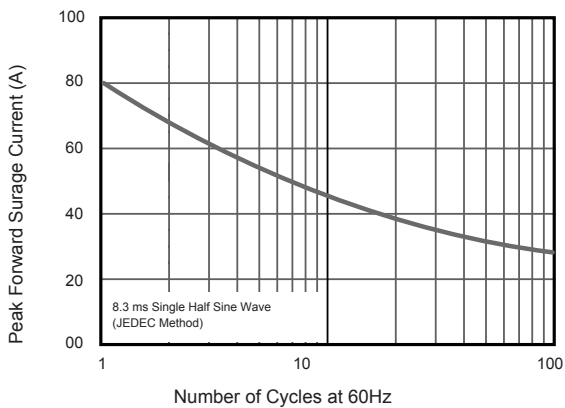
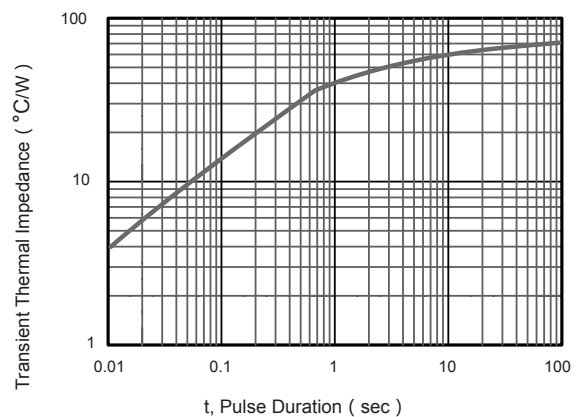
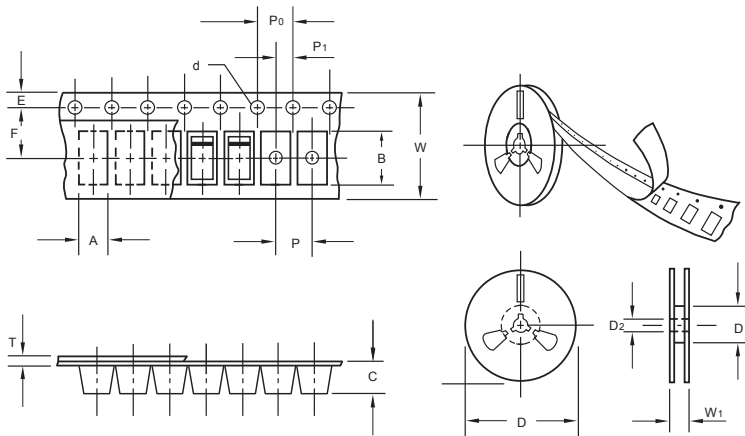

Fig.5- Typical Transient Thermal Impedance



The curve above is for reference only.

## Packing information



unit:mm

Item	Symbol	Tolerance	SMAF
Carrier width	A	0.1	2.80
Carrier length	B	0.1	4.75
Carrier depth	C	0.1	1.42
Sprocket hole	d	0.05	1.50
7" Reel outside diameter	D	2.0	178.00
7" Reel inner diameter	D1	min	54.40
Feed hole diameter	D2	0.5	13.00
Sprocket hole position	E	0.1	1.75
Punch hole position	F	0.1	5.05
Punch hole pitch	P	0.1	4.00
Sprocket hole pitch	P0	0.1	4.00
Embossment center	P1	0.1	2.00
Overall tape thickness	T	0.1	0.30
Tape width	W	0.3	8.00
Reel width	W1	1.0	12.30

Note: Devices are packed in accordance with EIA standard RS-481-A and specifications listed above.

## Reel packing

PACKAGE	REEL SIZE	REEL (pcs)	COMPONENT SPACING (m/m)	BOX (pcs)	INNER BOX (m/m)	REEL DIA, (m/m)	CARTON SIZE (m/m)	CARTON (pcs)	APPROX. GROSS WEIGHT (kg)
SMAF	7"	3,000	4.0	6,000	210*208*203	178	400*265*400	120,000	10.0

## Suggested Pad Layout



Symbol	Unit (mm)	Unit (inch)
A	1.8	0.071
B	1.6	0.063
C	3.8	0.150
D	2.2	0.087
E	5.4	0.213