

## LM45 SOT-23 Precision Centigrade Temperature Sensors

Check for Samples: [LM45](#)

### FEATURES

- **Calibrated Directly in ° Celsius (Centigrade)**
- **Linear + 10.0 mV/°C Scale Factor**
- **±3°C Accuracy Guaranteed**
- **Rated for Full –20° to +100°C Range**
- **Suitable for Remote Applications**
- **Low Cost Due to Wafer-Level Trimming**
- **Operates from 4.0V to 10V**
- **Less than 120 µA Current Drain**
- **Low Self-Heating, 0.20°C in Still Air**
- **Nonlinearity Only ±0.8°C Max Over Temp**
- **Low Impedance Output, 20Ω for 1 mA Load**

### APPLICATIONS

- **Battery Management**
- **FAX Machines**
- **Printers**
- **Portable Medical Instruments**
- **HVAC**
- **Power Supply Modules**
- **Disk Drives**
- **Computers**
- **Automotive**

### DESCRIPTION

The LM45 series are precision integrated-circuit temperature sensors, whose output voltage is linearly proportional to the Celsius (Centigrade) temperature. The LM45 does not require any external calibration or trimming to provide accuracies of ±2°C at room temperature and ±3°C over a full –20 to +100°C temperature range. Low cost is assured by trimming and calibration at the wafer level. The LM45's low output impedance, linear output, and precise inherent calibration make interfacing to readout or control circuitry especially easy. It can be used with a single power supply, or with plus and minus supplies. As it draws only 120 µA from its supply, it has very low self-heating, less than 0.2°C in still air. The LM45 is rated to operate over a –20° to +100°C temperature range.

### Connection Diagram

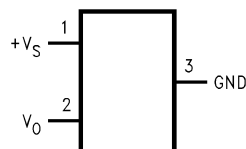

**Figure 1. SOT-23  
Top View  
Package Number DBZ0003A**



Please be aware that an important notice concerning availability, standard warranty, and use in critical applications of Texas Instruments semiconductor products and disclaimers thereto appears at the end of this data sheet.

All trademarks are the property of their respective owners.

## Typical Applications

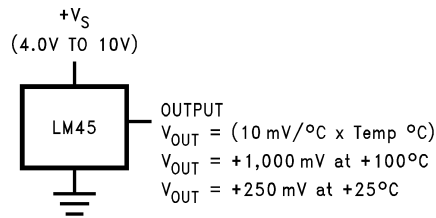

**Figure 2. Basic Centigrade Temperature Sensor (+2.5°C to +100°C)**

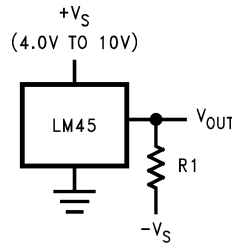

Choose  $R_1 = -V_S/50 \mu\text{A}$   
 $V_{\text{OUT}} = (10 \text{ mV}/^\circ\text{C} \times \text{Temp } ^\circ\text{C})$   
 $V_{\text{OUT}} = +1,000 \text{ mV at } +100^\circ\text{C}$   
 $= +250 \text{ mV at } +25^\circ\text{C}$   
 $= -200 \text{ mV at } -20^\circ\text{C}$

**Figure 3. Full-Range Centigrade Temperature Sensor (-20°C to +100°C)**



These devices have limited built-in ESD protection. The leads should be shorted together or the device placed in conductive foam during storage or handling to prevent electrostatic damage to the MOS gates.

### Absolute Maximum Ratings<sup>(1)</sup>

Supply Voltage	+12V to -0.2V	
Output Voltage	+V <sub>S</sub> + 0.6V to -1.0V	
Output Current	10 mA	
Storage Temperature	-65°C to +150°C	
ESD Susceptibility <sup>(2)</sup>	Human Body Model	2000V
	Machine Model	250V

(1) Absolute Maximum Ratings indicate limits beyond which damage to the device may occur. DC and AC electrical specifications do not apply when operating the device beyond its rated operating conditions.

(2) Human body model, 100 pF discharged through a 1.5 kΩ resistor. Machine model, 200 pF discharged directly into each pin.

### Operating Ratings<sup>(1)(2)(3)</sup>

Specified Temperature Range <sup>(4)</sup>	T <sub>MIN</sub> to T <sub>MAX</sub>	
LM45B, LM45C	-20°C to +100°C	
Operating Temperature Range		
LM45B, LM45C	-40°C to +125°C	
Supply Voltage Range (+V <sub>S</sub> )	+4.0V to +10V	

(1) Absolute Maximum Ratings indicate limits beyond which damage to the device may occur. DC and AC electrical specifications do not apply when operating the device beyond its rated operating conditions.

(2) Soldering process must comply with Reflow Temperature Profile specifications. Refer to <http://www.ti.com/packaging>.

(3) Reflow temperature profiles are different for lead-free and non-lead-free packages.

(4) Thermal resistance of the SOT-23 package is 260°C/W, junction to ambient when attached to a printed circuit board with 2 oz. foil as shown in Figure 15.

## Electrical Characteristics

Unless otherwise noted, these specifications apply for  $+V_S = +5\text{Vdc}$  and  $I_{\text{LOAD}} = +50\ \mu\text{A}$ , in the circuit of [Figure 3](#). These specifications also apply from  $+2.5^\circ\text{C}$  to  $T_{\text{MAX}}$  in the circuit of [Figure 2](#) for  $+V_S = +5\text{Vdc}$ . **Boldface limits apply for  $T_A = T_J = T_{\text{MIN}}$  to  $T_{\text{MAX}}$** ; all other limits  $T_A = T_J = +25^\circ\text{C}$ , unless otherwise noted.

Parameter	Conditions	LM45B		LM45C		Units (Limit)
		Typical	Limit <sup>(1)</sup>	Typical	Limit <sup>(1)</sup>	
Accuracy <sup>(2)</sup>	$T_A = +25^\circ\text{C}$		$\pm 2.0$		$\pm 3.0$	$^\circ\text{C}$ (max)
	$T_A = T_{\text{MAX}}$		$\pm 3.0$		$\pm 4.0$	
	$T_A = T_{\text{MIN}}$		$\pm 3.0$		$\pm 4.0$	
Nonlinearity <sup>(3)</sup>	$T_{\text{MIN}} \leq T_A \leq T_{\text{MAX}}$		<b><math>\pm 0.8</math></b>		<b><math>\pm 0.8</math></b>	$^\circ\text{C}$ (max)
Sensor Gain (Average Slope)	$T_{\text{MIN}} \leq T_A \leq T_{\text{MAX}}$		<b>+9.7</b>		<b>+9.7</b>	mV/ $^\circ\text{C}$ (min)
			<b>+10.3</b>		<b>+10.3</b>	mV/ $^\circ\text{C}$ (max)
Load Regulation <sup>(4)</sup>	$0 \leq I_L \leq +1\ \text{mA}$		<b><math>\pm 35</math></b>		<b><math>\pm 35</math></b>	mV/mA (max)
Line Regulation <sup>(4)</sup>	$+4.0\text{V} \leq +V_S \leq +10\text{V}$		$\pm 0.80$		$\pm 0.80$	mV/V (max)
			<b><math>\pm 1.2</math></b>		<b><math>\pm 1.2</math></b>	
Quiescent Current <sup>(5)</sup>	$+4.0\text{V} \leq +V_S \leq +10\text{V}$ , $+25^\circ\text{C}$		120		120	$\mu\text{A}$ (max)
	$+4.0\text{V} \leq +V_S \leq +10\text{V}$		<b>160</b>		<b>160</b>	
Change of Quiescent Current <sup>(5)</sup>	$4.0\text{V} \leq +V_S \leq 10\text{V}$		<b>2.0</b>		<b>2.0</b>	$\mu\text{A}$ (max)
Temperature Coefficient of Quiescent Current			<b>+2.0</b>		<b>+2.0</b>	$\mu\text{A}/^\circ\text{C}$
Minimum Temperature for Rated Accuracy	In circuit of <a href="#">Figure 2</a> , $I_L = 0$		+2.5		+2.5	$^\circ\text{C}$ (min)
Long Term Stability <sup>(6)</sup>	$T_J = T_{\text{MAX}}$ , for 1000 hours		$\pm 0.12$		$\pm 0.12$	$^\circ\text{C}$

- (1) Limits are guaranteed to TI's AOQL (Average Outgoing Quality Level).
- (2) Accuracy is defined as the error between the output voltage and  $10\ \text{mV}/^\circ\text{C}$  times the device's case temperature, at specified conditions of voltage, current, and temperature (expressed in  $^\circ\text{C}$ ).
- (3) Nonlinearity is defined as the deviation of the output-voltage-versus-temperature curve from the best-fit straight line, over the device's rated temperature range.
- (4) Regulation is measured at constant junction temperature, using pulse testing with a low duty cycle. Changes in output due to heating effects can be computed by multiplying the internal dissipation by the thermal resistance.
- (5) Quiescent current is measured using the circuit of [Figure 2](#).
- (6) For best long-term stability, any precision circuit will give best results if the unit is aged at a warm temperature, and/or temperature cycled for at least 46 hours before long-term life test begins. This is especially true when a small (Surface-Mount) part is wave-soldered; allow time for stress relaxation to occur.

### Typical Performance Characteristics

To generate these curves the LM45 was mounted to a printed circuit board as shown in [Figure 15](#).

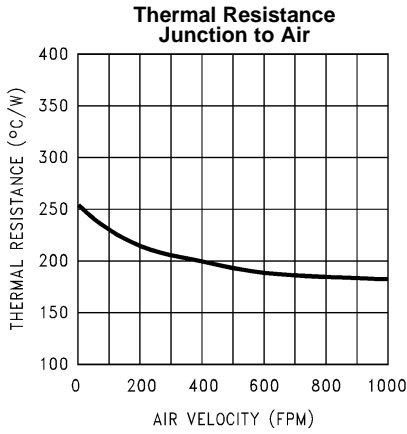

Figure 4.

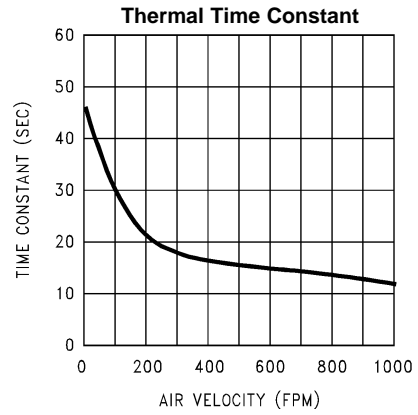

Figure 5.

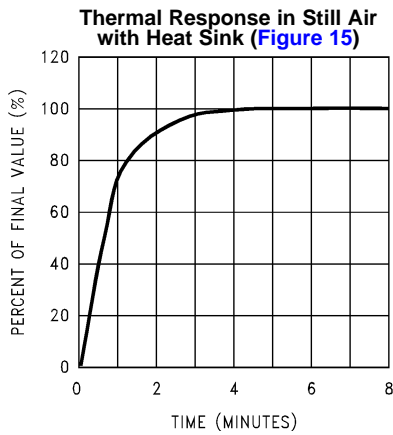

Figure 6.

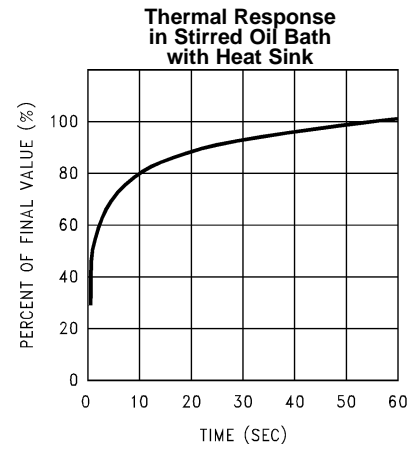

Figure 7.

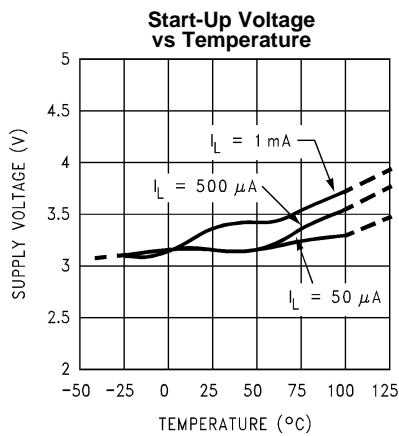

Figure 8.

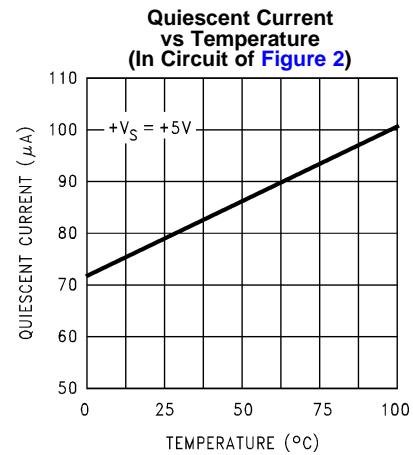

Figure 9.

Typical Performance Characteristics (continued)

To generate these curves the LM45 was mounted to a printed circuit board as shown in Figure 15.

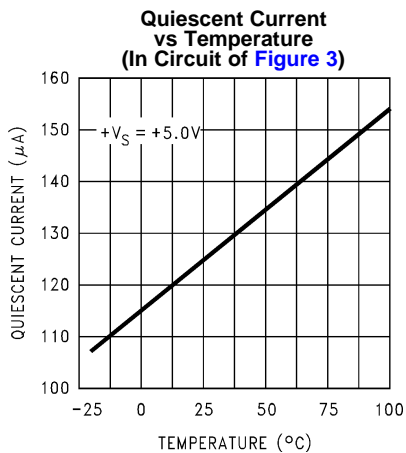

Figure 10.

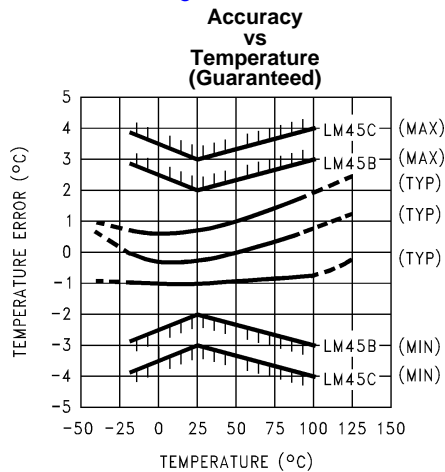

Figure 11.

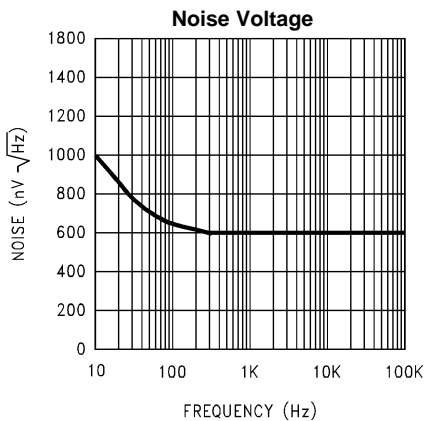

Figure 12.

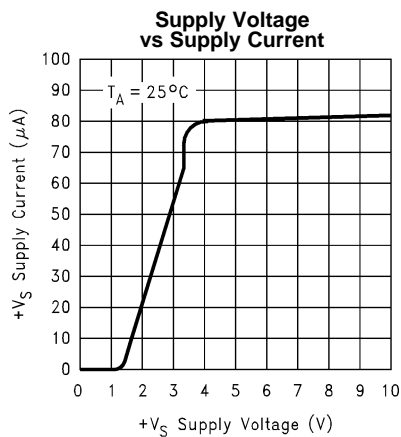

Figure 13.

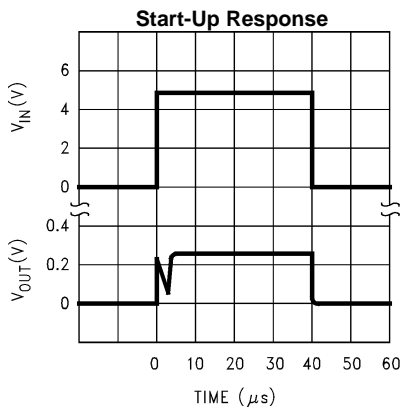
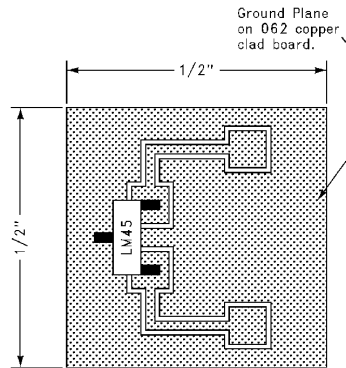

Figure 14.

## PRINTED CIRCUIT BOARD



Printed Circuit Board Used for Heat Sink to Generate All Curves.

**Figure 15. 1/2" Square Printed Circuit Board with 2 oz. Foil or Similar**

## APPLICATIONS

The LM45 can be applied easily in the same way as other integrated-circuit temperature sensors. It can be glued or cemented to a surface and its temperature will be within about 0.2°C of the surface temperature.

This presumes that the ambient air temperature is almost the same as the surface temperature; if the air temperature were much higher or lower than the surface temperature, the actual temperature of the LM45 die would be at an intermediate temperature between the surface temperature and the air temperature.

To ensure good thermal conductivity the backside of the LM45 die is directly attached to the GND pin. The lands and traces to the LM45 will, of course, be part of the printed circuit board, which is the object whose temperature is being measured. These printed circuit board lands and traces will not cause the LM45s temperature to deviate from the desired temperature.

Alternatively, the LM45 can be mounted inside a sealed-end metal tube, and can then be dipped into a bath or screwed into a threaded hole in a tank. As with any IC, the LM45 and accompanying wiring and circuits must be kept insulated and dry, to avoid leakage and corrosion. This is especially true if the circuit may operate at cold temperatures where condensation can occur. Printed-circuit coatings and varnishes such as Humiseal and epoxy paints or dips are often used to insure that moisture cannot corrode the LM45 or its connections.

Temperature Rise of LM45 Due to Self-Heating (Thermal Resistance)

	SOT-23	SOT-23
	no heat sink*	small heat fin**
Still air	450°C/W	260°C/W
Moving air		180°C/W

## Typical Applications

### CAPACITIVE LOADS

Like most micropower circuits, the LM45 has a limited ability to drive heavy capacitive loads. The LM45 by itself is able to drive 500 pF without special precautions. If heavier loads are anticipated, it is easy to isolate or decouple the load with a resistor; see [Figure 16](#). Or you can improve the tolerance of capacitance with a series R-C damper from output to ground; see [Figure 17](#).

Any linear circuit connected to wires in a hostile environment can have its performance affected adversely by intense electromagnetic sources such as relays, radio transmitters, motors with arcing brushes, SCR transients, etc, as its wiring can act as a receiving antenna and its internal junctions can act as rectifiers. For best results in such cases, a bypass capacitor from  $V_{IN}$  to ground and a series R-C damper such as 75Ω in series with 0.2 or 1 μF from output to ground, as shown in [Figure 17](#), are often useful.

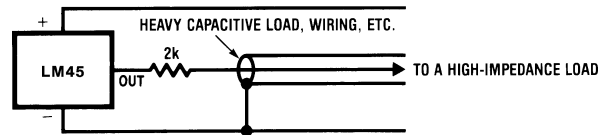

Figure 16. LM45 with Decoupling from Capacitive Load

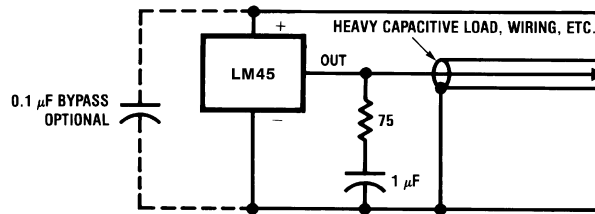

Figure 17. LM45 with R-C Damper

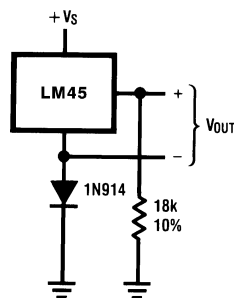

Figure 18. Temperature Sensor, Single Supply, -20°C to +100°C

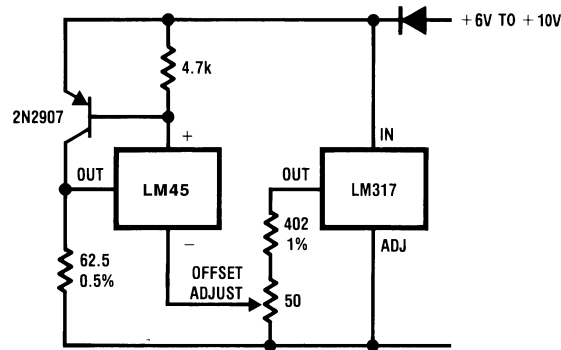

Figure 19. 4-to-20 mA Current Source (0°C to +100°C)

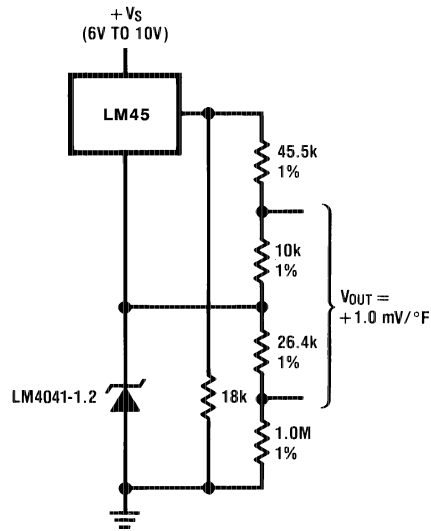

Figure 20. Fahrenheit Thermometer

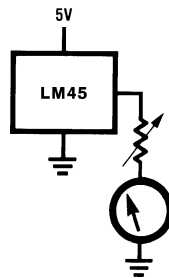

Figure 21. Centigrade Thermometer (Analog Meter)

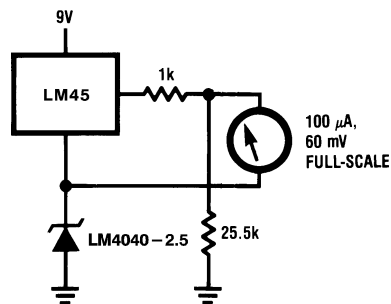

Figure 22. Expanded Scale Thermometer (50° to 80° Fahrenheit, for Example Shown)







Block Diagram

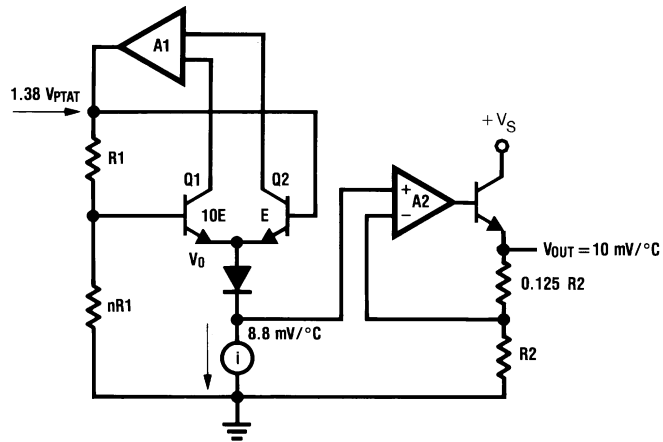

### REVISION HISTORY

Changes from Revision B (February 2013) to Revision C	Page
• Changed layout of National Data Sheet to TI format .....	<a href="#">11</a>

**PACKAGING INFORMATION**

Orderable Device	Status (1)	Package Type	Package Drawing	Pins	Package Qty	Eco Plan (2)	Lead/Ball Finish (6)	MSL Peak Temp (3)	Op Temp (°C)	Device Marking (4/5)	Samples
LM45BIM3	NRND	SOT-23	DBZ	3	1000	TBD	Call TI	Call TI	-20 to 100	T4B	
LM45BIM3/NOPB	ACTIVE	SOT-23	DBZ	3	1000	Green (RoHS & no Sb/Br)	CU SN	Level-1-260C-UNLIM	-20 to 100	T4B	<a href="#">Samples</a>
LM45BIM3X/NOPB	ACTIVE	SOT-23	DBZ	3	3000	Green (RoHS & no Sb/Br)	CU SN	Level-1-260C-UNLIM	-20 to 100	T4B	<a href="#">Samples</a>
LM45CIM3/NOPB	ACTIVE	SOT-23	DBZ	3	1000	Green (RoHS & no Sb/Br)	CU SN	Level-1-260C-UNLIM	-20 to 100	T4C	<a href="#">Samples</a>
LM45CIM3X	NRND	SOT-23	DBZ	3	3000	TBD	Call TI	Call TI	-20 to 100	T4C	
LM45CIM3X/NOPB	ACTIVE	SOT-23	DBZ	3	3000	Green (RoHS & no Sb/Br)	CU SN	Level-1-260C-UNLIM	-20 to 100	T4C	<a href="#">Samples</a>

(1) The marketing status values are defined as follows:

**ACTIVE:** Product device recommended for new designs.

**LIFEBUY:** TI has announced that the device will be discontinued, and a lifetime-buy period is in effect.

**NRND:** Not recommended for new designs. Device is in production to support existing customers, but TI does not recommend using this part in a new design.

**PREVIEW:** Device has been announced but is not in production. Samples may or may not be available.

**OBSOLETE:** TI has discontinued the production of the device.

(2) **RoHS:** TI defines "RoHS" to mean semiconductor products that are compliant with the current EU RoHS requirements for all 10 RoHS substances, including the requirement that RoHS substance do not exceed 0.1% by weight in homogeneous materials. Where designed to be soldered at high temperatures, "RoHS" products are suitable for use in specified lead-free processes. TI may reference these types of products as "Pb-Free".

**RoHS Exempt:** TI defines "RoHS Exempt" to mean products that contain lead but are compliant with EU RoHS pursuant to a specific EU RoHS exemption.

**Green:** TI defines "Green" to mean the content of Chlorine (Cl) and Bromine (Br) based flame retardants meet JS709B low halogen requirements of <=1000ppm threshold. Antimony trioxide based flame retardants must also meet the <=1000ppm threshold requirement.

(3) MSL, Peak Temp. - The Moisture Sensitivity Level rating according to the JEDEC industry standard classifications, and peak solder temperature.

(4) There may be additional marking, which relates to the logo, the lot trace code information, or the environmental category on the device.

(5) Multiple Device Markings will be inside parentheses. Only one Device Marking contained in parentheses and separated by a "~" will appear on a device. If a line is indented then it is a continuation of the previous line and the two combined represent the entire Device Marking for that device.

(6) Lead/Ball Finish - Orderable Devices may have multiple material finish options. Finish options are separated by a vertical ruled line. Lead/Ball Finish values may wrap to two lines if the finish value exceeds the maximum column width.

**Important Information and Disclaimer:** The information provided on this page represents TI's knowledge and belief as of the date that it is provided. TI bases its knowledge and belief on information provided by third parties, and makes no representation or warranty as to the accuracy of such information. Efforts are underway to better integrate information from third parties. TI has taken and continues to take reasonable steps to provide representative and accurate information but may not have conducted destructive testing or chemical analysis on incoming materials and chemicals. TI and TI suppliers consider certain information to be proprietary, and thus CAS numbers and other limited information may not be available for release.

In no event shall TI's liability arising out of such information exceed the total purchase price of the TI part(s) at issue in this document sold by TI to Customer on an annual basis.

## TAPE AND REEL INFORMATION



### QUADRANT ASSIGNMENTS FOR PIN 1 ORIENTATION IN TAPE

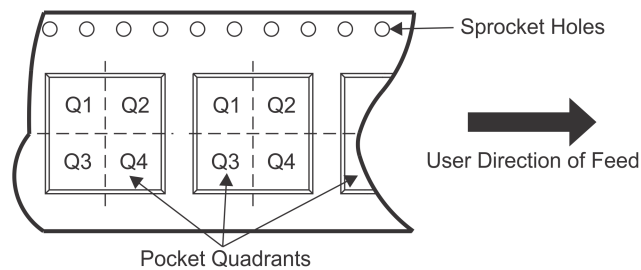

\*All dimensions are nominal

Device	Package Type	Package Drawing	Pins	SPQ	Reel Diameter (mm)	Reel Width W1 (mm)	A0 (mm)	B0 (mm)	K0 (mm)	P1 (mm)	W (mm)	Pin1 Quadrant
LM45BIM3	SOT-23	DBZ	3	1000	178.0	8.4	3.3	2.9	1.22	4.0	8.0	Q3
LM45BIM3/NOPB	SOT-23	DBZ	3	1000	178.0	8.4	3.3	2.9	1.22	4.0	8.0	Q3
LM45BIM3X/NOPB	SOT-23	DBZ	3	3000	178.0	8.4	3.3	2.9	1.22	4.0	8.0	Q3
LM45CIM3/NOPB	SOT-23	DBZ	3	1000	178.0	8.4	3.3	2.9	1.22	4.0	8.0	Q3
LM45CIM3X	SOT-23	DBZ	3	3000	178.0	8.4	3.3	2.9	1.22	4.0	8.0	Q3
LM45CIM3X/NOPB	SOT-23	DBZ	3	3000	178.0	8.4	3.3	2.9	1.22	4.0	8.0	Q3

**TAPE AND REEL BOX DIMENSIONS**

\*All dimensions are nominal

Device	Package Type	Package Drawing	Pins	SPQ	Length (mm)	Width (mm)	Height (mm)
LM45BIM3	SOT-23	DBZ	3	1000	210.0	185.0	35.0
LM45BIM3/NOPB	SOT-23	DBZ	3	1000	210.0	185.0	35.0
LM45BIM3X/NOPB	SOT-23	DBZ	3	3000	210.0	185.0	35.0
LM45CIM3/NOPB	SOT-23	DBZ	3	1000	210.0	185.0	35.0
LM45CIM3X	SOT-23	DBZ	3	3000	210.0	185.0	35.0
LM45CIM3X/NOPB	SOT-23	DBZ	3	3000	210.0	185.0	35.0



**GENERIC PACKAGE VIEW**

**DBZ 3**

**SOT-23 - 1.12 mm max height**

SMALL OUTLINE TRANSISTOR

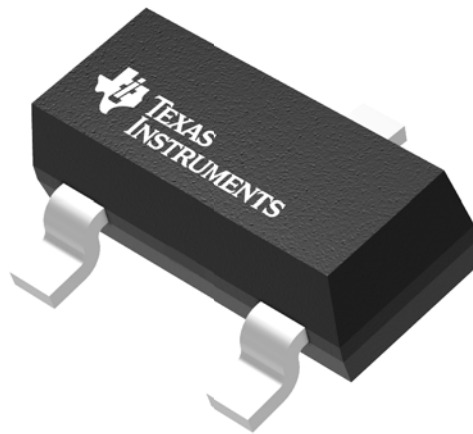

Images above are just a representation of the package family, actual package may vary.  
Refer to the product data sheet for package details.

4203227/C

DBZ0003A



# PACKAGE OUTLINE

SOT-23 - 1.12 mm max height

SMALL OUTLINE TRANSISTOR

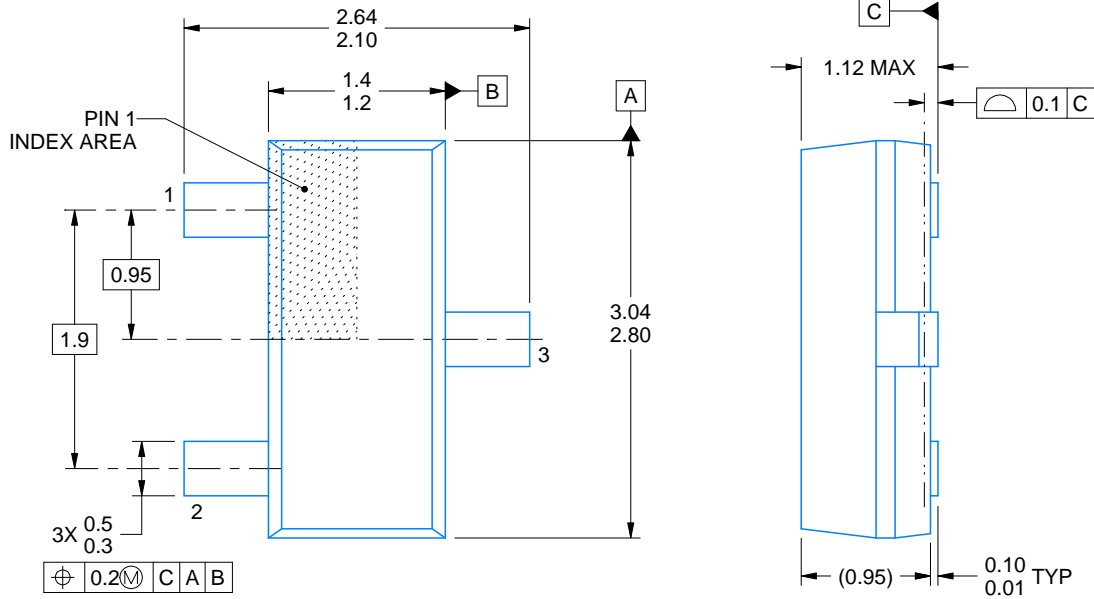

4214838/C 04/2017

NOTES:

1. All linear dimensions are in millimeters. Any dimensions in parenthesis are for reference only. Dimensioning and tolerancing per ASME Y14.5M.
2. This drawing is subject to change without notice.
3. Reference JEDEC registration TO-236, except minimum foot length.

# EXAMPLE BOARD LAYOUT

DBZ0003A

SOT-23 - 1.12 mm max height

SMALL OUTLINE TRANSISTOR

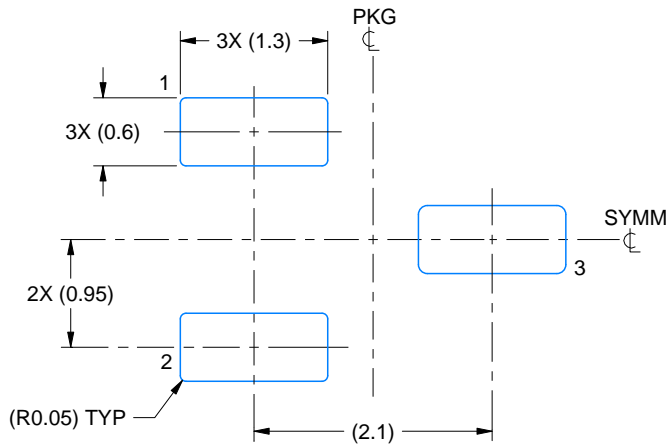

LAND PATTERN EXAMPLE  
SCALE:15X

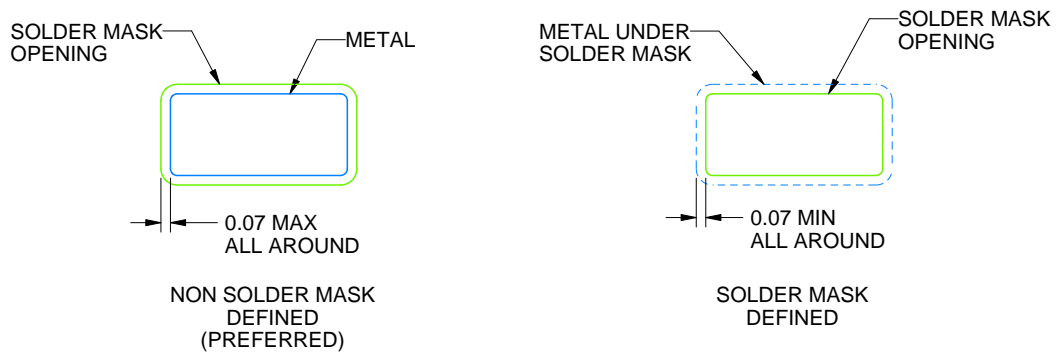

SOLDER MASK DETAILS

4214838/C 04/2017

NOTES: (continued)

4. Publication IPC-7351 may have alternate designs.
5. Solder mask tolerances between and around signal pads can vary based on board fabrication site.

# EXAMPLE STENCIL DESIGN

DBZ0003A

SOT-23 - 1.12 mm max height

SMALL OUTLINE TRANSISTOR

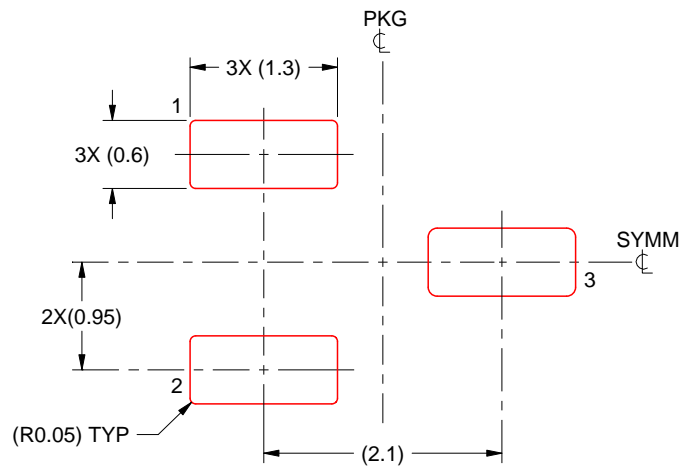

SOLDER PASTE EXAMPLE  
BASED ON 0.125 THICK STENCIL  
SCALE:15X

4214838/C 04/2017

NOTES: (continued)

6. Laser cutting apertures with trapezoidal walls and rounded corners may offer better paste release. IPC-7525 may have alternate design recommendations.
7. Board assembly site may have different recommendations for stencil design.

## IMPORTANT NOTICE AND DISCLAIMER

TI PROVIDES TECHNICAL AND RELIABILITY DATA (INCLUDING DATASHEETS), DESIGN RESOURCES (INCLUDING REFERENCE DESIGNS), APPLICATION OR OTHER DESIGN ADVICE, WEB TOOLS, SAFETY INFORMATION, AND OTHER RESOURCES "AS IS" AND WITH ALL FAULTS, AND DISCLAIMS ALL WARRANTIES, EXPRESS AND IMPLIED, INCLUDING WITHOUT LIMITATION ANY IMPLIED WARRANTIES OF MERCHANTABILITY, FITNESS FOR A PARTICULAR PURPOSE OR NON-INFRINGEMENT OF THIRD PARTY INTELLECTUAL PROPERTY RIGHTS.

These resources are intended for skilled developers designing with TI products. You are solely responsible for (1) selecting the appropriate TI products for your application, (2) designing, validating and testing your application, and (3) ensuring your application meets applicable standards, and any other safety, security, or other requirements. These resources are subject to change without notice. TI grants you permission to use these resources only for development of an application that uses the TI products described in the resource. Other reproduction and display of these resources is prohibited. No license is granted to any other TI intellectual property right or to any third party intellectual property right. TI disclaims responsibility for, and you will fully indemnify TI and its representatives against, any claims, damages, costs, losses, and liabilities arising out of your use of these resources.

TI's products are provided subject to TI's Terms of Sale ([www.ti.com/legal/termsofsale.html](http://www.ti.com/legal/termsofsale.html)) or other applicable terms available either on [ti.com](http://ti.com) or provided in conjunction with such TI products. TI's provision of these resources does not expand or otherwise alter TI's applicable warranties or warranty disclaimers for TI products.

Mailing Address: Texas Instruments, Post Office Box 655303, Dallas, Texas 75265  
Copyright © 2018, Texas Instruments Incorporated