

## Digital Transistors (Built-in Resistors)

### UMH11N Dual Digital Transistors (NPN+NPN)

#### FEATURES

- Two DTC114E chip in a package
- Mounting possible with SOT-363 automatic mounting machines
- Transistor elements are independent, eliminating interference
- Mounting cost and area be cut in half

Marking: H11

K

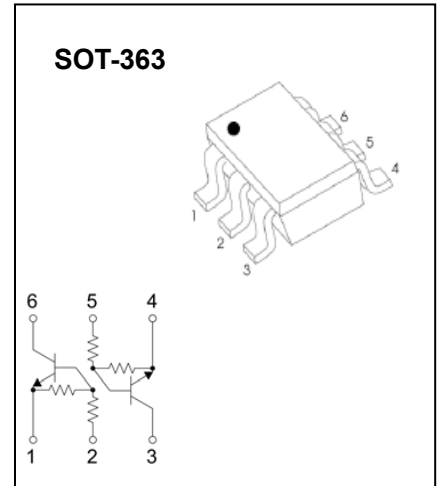

#### Absolute maximum ratings(Ta=25°C)

Parameter	Symbol	Limits	Unit
Supply voltage	$V_{CC}$	50	V
Input voltage	$V_{IN}$	-10~40	V
Output current	$I_O$	50	mA
	$I_{C(MAX)}$	100	
Power dissipation	$P_d$	150	mW
Operation Junction and Storage Temperature Range	$T_J, T_{stg}$	-55~+150	°C

#### Electrical characteristics (Ta=25°C)

Parameter	Symbol	Min	Typ	Max	Unit	Conditions
Input voltage	$V_{I(off)}$	0.5			V	$V_{CC}=5V, I_O=100\mu A$
	$V_{I(on)}$			3		$V_O=0.3V, I_O=10mA$
Output voltage	$V_{O(on)}$		0.1	0.3	V	$I_O/I_I=10mA/0.5mA$
Input current	$I_I$			0.88	mA	$V_I=5V$
Output current	$I_{O(off)}$			0.5	$\mu A$	$V_{CC}=50V, V_I=0$
DC current gain	$G_1$	30				$V_O=5V, I_O=5mA$
Input resistance	$R_1$	7	10	13	$\Omega$	
Resistance ratio	$R_2/R_1$	0.8	1	1.2		
Transition frequency	$f_T$		250		MHz	$V_{CE}=10V, I_E=5mA, f=100MHz$

# Typical Characteristics

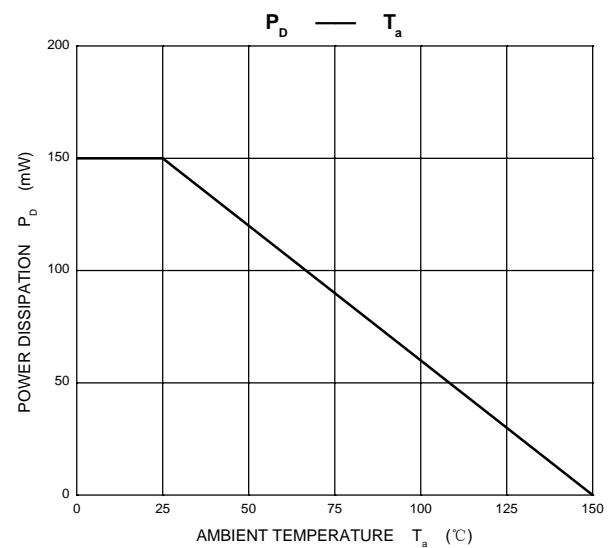
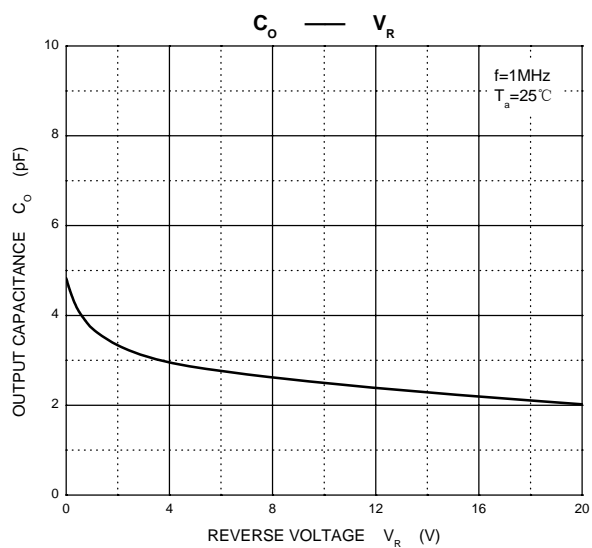
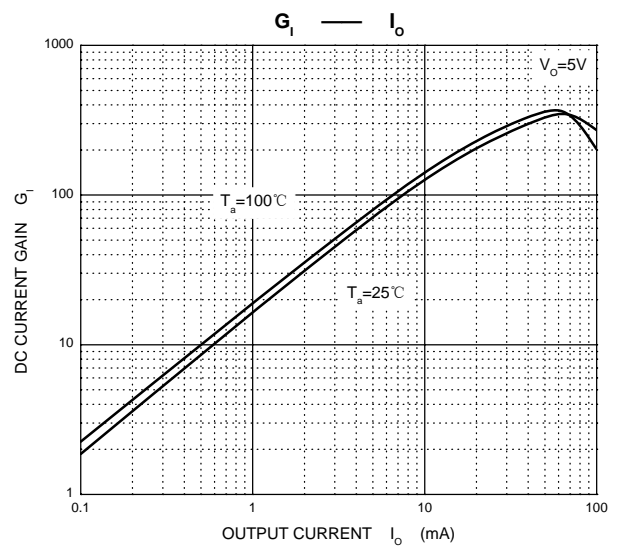
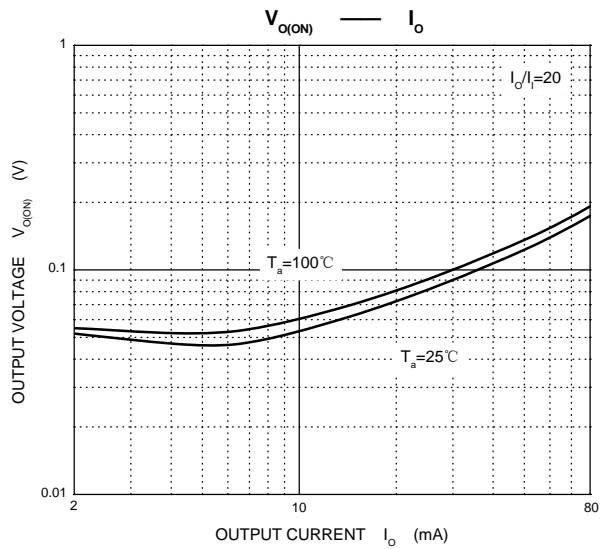
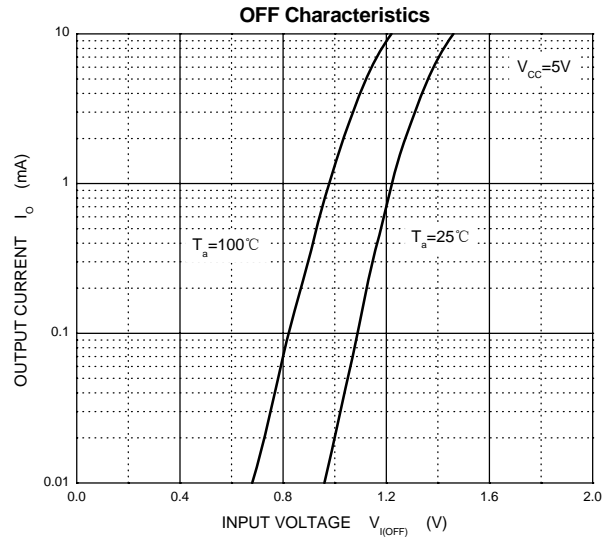
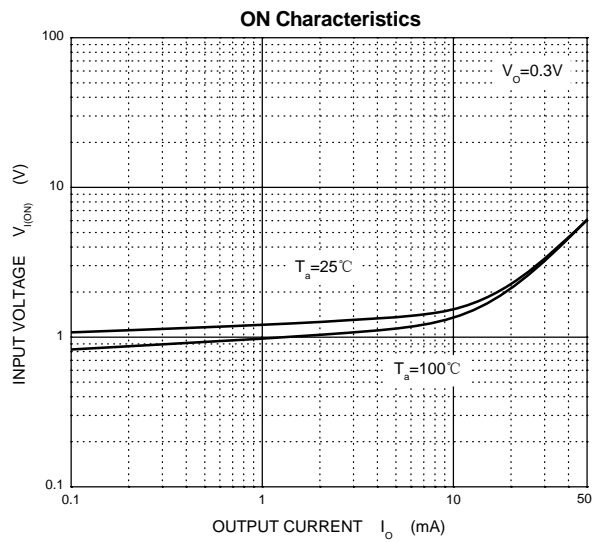

## SOT-363 Package Outline Dimensions

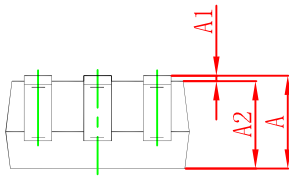
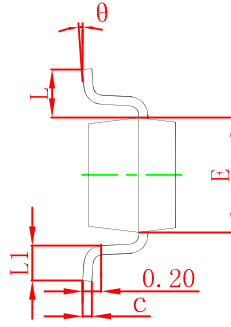
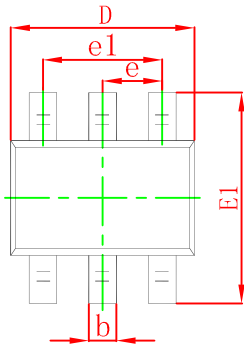

Symbol	Dimensions In Millimeters		Dimensions In Inches	
	Min	Max	Min	Max
A	0.900	1.100	0.035	0.043
A1	0.000	0.100	0.000	0.004
A2	0.900	1.000	0.035	0.039
b	0.150	0.350	0.006	0.014
c	0.100	0.150	0.004	0.006
D	2.000	2.200	0.079	0.087
E	1.150	1.350	0.045	0.053
E1	2.150	2.400	0.085	0.094
e	0.650 TYP		0.026 TYP	
e1	1.200	1.400	0.047	0.055
L	0.525 REF		0.021 REF	
L1	0.260	0.460	0.010	0.018
theta	0°	8°	0°	8°

## SOT-363 Suggested Pad Layout

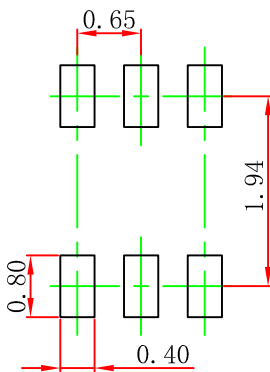

Note:

1. Controlling dimension: in millimeters.
2. General tolerance:  $\pm 0.05\text{mm}$ .
3. The pad layout is for reference purposes only.

### NOTICE

JSCJ reserves the right to make modifications, enhancements, improvements, corrections or other changes without further notice to any product herein. JSCJ does not assume any liability arising out of the application or use of any product described herein.

# SOT-363 Tape and Reel

## SOT-363 Embossed Carrier Tape

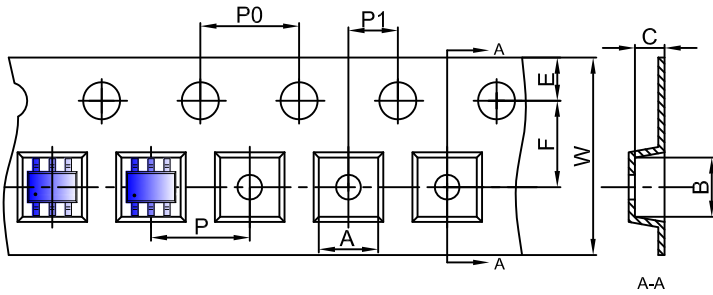

### Packaging Description:

SOT-363 parts are shipped in tape. The carrier tape is made from a dissipative (carbon filled) polycarbonate resin. The cover tape is a multilayer film (Heat Activated Adhesive in nature) primarily composed of polyester film, adhesive layer, sealant, and anti-static sprayed agent. These reeled parts in standard option are shipped with 3,000 units per 7" or 17.8cm diameter reel. The reels are clear in color and is made of polystyrene plastic (anti-static coated).

Dimensions are in millimeter										
Pkg type	A	B	C	d	E	F	P0	P	P1	W
SOT-363	2.25	2.55	1.20	Ø1.50	1.75	3.50	4.00	4.00	2.00	8.00

## SOT-363 Tape Leader and Trailer

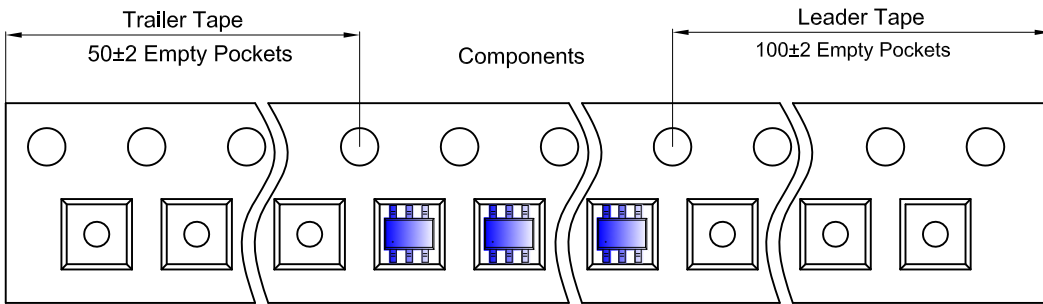

## SOT-363 Reel

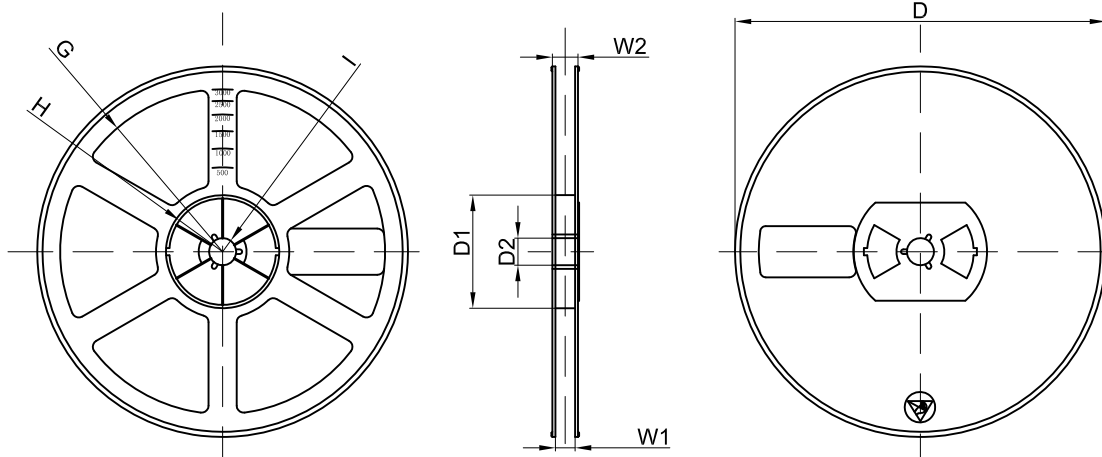

Dimensions are in millimeter								
Reel Option	D	D1	D2	G	H	I	W1	W2
7" Dia	Ø178.00	54.40	13.00	R78.00	R25.60	R6.50	9.50	12.30

REEL	Reel Size	Box	Box Size(mm)	Carton	Carton Size(mm)	G.W.(kg)
3000 pcs	7 inch	45,000 pcs	203×203×195	180,000 pcs	438×438×220	