

标记 MARK	ECN编号/变更内容 ECN NO/DEFINITION					修改 REVISE	日期 DATE			核准 APPROVE		
PIN	DIM A	DIM B	PIN	DIM A	DIM B	PIN	DIM A	DIM B	PIN	DIM A	DIM B	
1	—	—	11	12.70	13.97	21	25.40	26.67	31	38.10	39.37	
2	1.27	2.54	12	13.97	15.24	22	26.67	27.94	32	39.37	40.64	
3	2.54	3.81	13	15.24	16.51	23	27.94	29.21	33	40.64	41.91	
4	3.81	5.08	14	16.51	17.78	24	29.21	30.48	34	41.91	43.18	
5	5.08	6.35	15	17.78	19.05	25	30.48	31.75	35	43.18	44.45	
6	6.35	7.62	16	19.05	20.32	26	31.75	33.02	36	44.45	45.72	
7	7.62	8.89	17	20.32	21.59	27	33.02	34.29	37	45.72	46.99	
8	8.89	10.16	18	21.59	22.86	28	34.29	35.56	38	46.99	48.26	
9	10.16	11.43	19	22.86	24.13	29	35.56	36.83	39	48.26	49.53	
10	11.43	12.70	20	24.13	25.40	30	36.83	38.10	40	49.53	50.80	

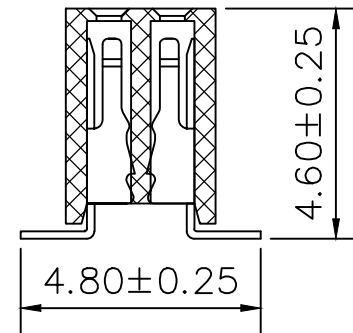

SPECIFICATIONS
 Current Rating: 1.0 Amps
 Withstanding Voltage: AC 500V
 Insulation Resistance: 1000MΩ Min
 Contact Resistance: 20mΩ Max
 Operation Temperature: -40°to+105°
 Insulator Material: Polyester
 Contact Material: Phosphor bronze
 Standard: PA6T
 Contact Plating: Gold Flash
 Max.Processing Temp: 200°C for 30-60seconds
 (255°C for 5seconds)

H	PC	PB
4.3	4.8	4.6

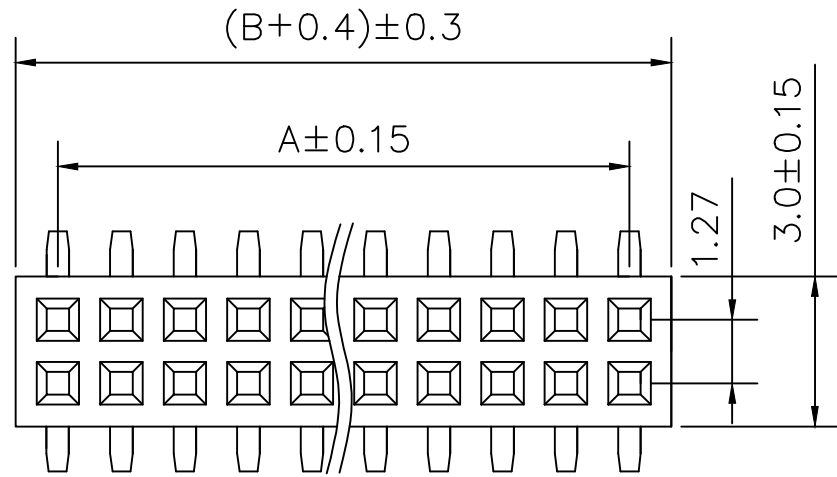
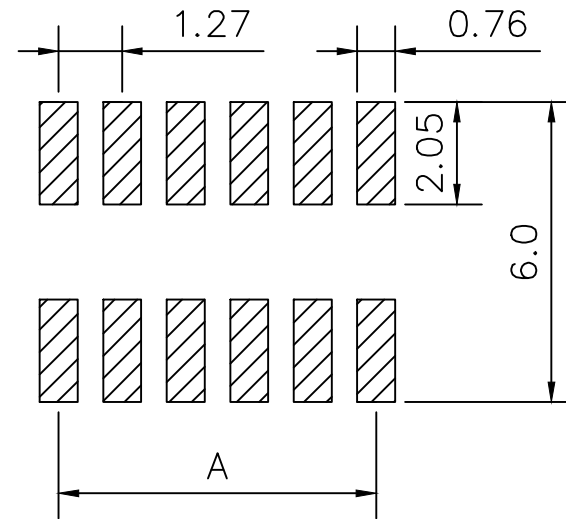
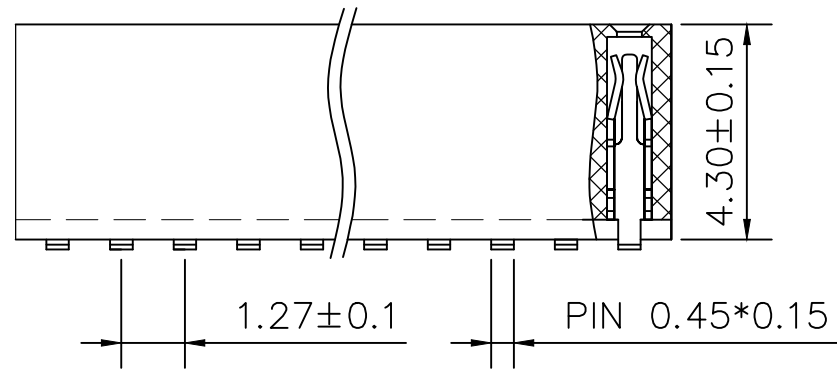

RECOMMEND P. C. B LAYOUT
 PCB TOLERANCE: ±0.05 (TOP VIEW)

2	接触	铜	镀金	
1	基座	PA6T	本色	
序号	品名	材质	电镀/颜色	备注

	深圳市虹成电子有限公司		品名 TITLE	排母	
			料号 PART NO	HC-PM127-4.3H-2x13PS	
一般公差 TOLERANCE	比列 SCALE	1:1			
X : ±0.30 X° : ±5°	单位 UNIT	MM			
X.X : ±0.25 X.X° : ±1°	张数 PART NO	1 OF 1			
X.XX : ±0.20 X.XX° : ±0.5°	版本 REV	A		制图 DRAW	AhYe
				审核 CHECKED	夏操云
				批准 APPROVE	赵亮亮

