

**NOTES**

- 1. 端子テール部及びネイルの平坦度:0.1 MAX  
TAIL AND NAIL COPLANARITY TO BE 0.1 MAX
- △2 極数 = 偶数に適用  
APPLY FOR CIRCUIT SIZE = EVEN
- △3 関連製品、書類はSHEET 5を参照のこと  
REFER TO SHEET 5 ABOUT RELATED PRODUCTS OR DOCUMENTS.
- △4 オーダー番号(製品番号) : SHEET 6の製品一覧を参照ください  
ORDER No (MATERIAL No) : REFER TO SHEET 6 FOR PRODUCT LIST

**213225 \*\*\*\***

シリーズ番号 ↑ 極数 ↑ 色 ↑  
SERIES NO CIRCUIT SIZE COLOR  
金めつき厚 ↑  
GOLD PLATING THICKNESS

CIRCUIT	No.	GOLD THK [micro-meters]	No.	COLOR
02 ~ 15	1	0.1	0	ナチュラル NATURAL
	3	0.38	1	黒 BLACK
	7	0.76		

25	±0.25	21	26.8	±0.25	15		
23.5		19.5	25.3		14		
22		18	23.8		13		
20.5		16.5	22.3		12		
19		15	20.8		11		
17.5		13.5	19.3		10		
16		12	17.8		9		
14.5		10.5	16.3		8		
13		9	14.8		7		
11.5		7.5	13.3		6		
10		6	11.8		5		
8.5		(±0.20)	4.5		10.3	(±0.20)	4
7			3		8.8		3
5.5			1.5		7.3		2
		C	B		A	極数 CKT NO	

番号 NO.	部品 PART	材質 MATERIAL	
①	ハウジング HOUSING	ポリアミド(PA) UL94V-0 色 : SEE CHART POLYAMIDE(PA) UL94V-0 COLOR : SEE CHART	
②	ターミナル TERMINAL	銅合金 COPPER ALLOY	
		コンタクト部 CONTACT AREA	金めつき : 製品一覧参照 GOLD PLATING : SEE PRODUCT LIST
		テール部 TAIL AREA	無光沢錫めつき : 1.0 micro-meter MIN MATTE TIN PLATING : 1.0 micro-meter MIN
③	ネイル NAIL	下地めつき(全面) UNDER PLATING (WHOLE SURFACE)	ニッケルめつき : 1.0 micro-meter MIN NICKEL PLATING : 1.0 micro-meter MIN
		黄銅 BRASS	無光沢錫めつき : 1.0 micro-meter MIN MATTE TIN PLATING
		ニッケルめつき(下地) : 1.0 micro-meter MIN NICKEL PLATING (UNDER PLATING)	

DOCUMENT STATUS	P1	RELEASE DATE	2023/06/23	10:36:34
-----------------	----	--------------	------------	----------

THIS DRAWING CONTAINS INFORMATION THAT IS PROPRIETARY TO MOLEX ELECTRONIC TECHNOLOGIES, LLC AND SHOULD NOT BE USED WITHOUT WRITTEN PERMISSION

DIMENSION UNITS	SCALE	CURRENT REV DESC:	<b>molex</b>		
mm	NTS				
GENERAL TOLERANCES (UNLESS SPECIFIED)			CLIK-MATE 1.5 SINGLE ROW SMT VT TYPE REC ASSY GOLD PLATING		
ANGULAR TOL	± 3.0 °	EC NO: 742719	PRODUCT CUSTOMER DRAWING		
4 PLACES	± 0.2	DRWN: MIKEDA01	DOCUMENT NUMBER		
3 PLACES	± 0.2	CHK'D: SAKIYAMA	DOC TYPE		
2 PLACES	± 0.2	APPR: AIDA	DOC PART		
1 PLACE	± 0.2	INITIAL REVISION:	REVISION		
0 PLACES	± 0.2	DRWN: MIKEDA01	2132250000-SD		
		APPR: KOMURAKAMI	PSD 000 F		
DRAFT WHERE APPLICABLE MUST REMAIN WITHIN DIMENSIONS	THIRD ANGLE PROJECTION	DRAWING	SERIES	MATERIAL NUMBER	CUSTOMER
		A3-SIZE	213225	GENERAL	SHEET NUMBER
					1 OF 6



製品レイアウト  
PRODUCT LAYOUT

コネクタ外形  
CONNECTOR OUTLINE

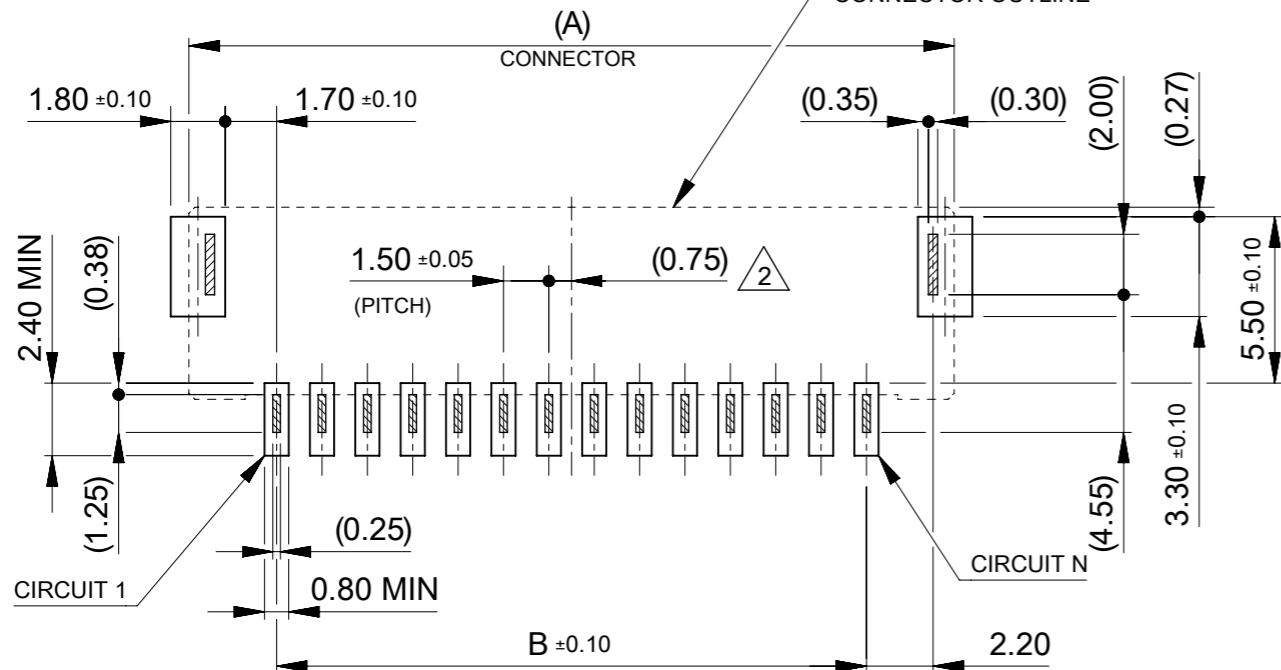

基板レイアウト(参考)

PCB PATTERN LAYOUT (REFERENCE)

(参考:メタルマスク厚さ 0.10mm, マスク開口率100%)  
(REFERENCE:METAL MASK THICKNESS 0.10mm, APERTURE RATIO 100%)

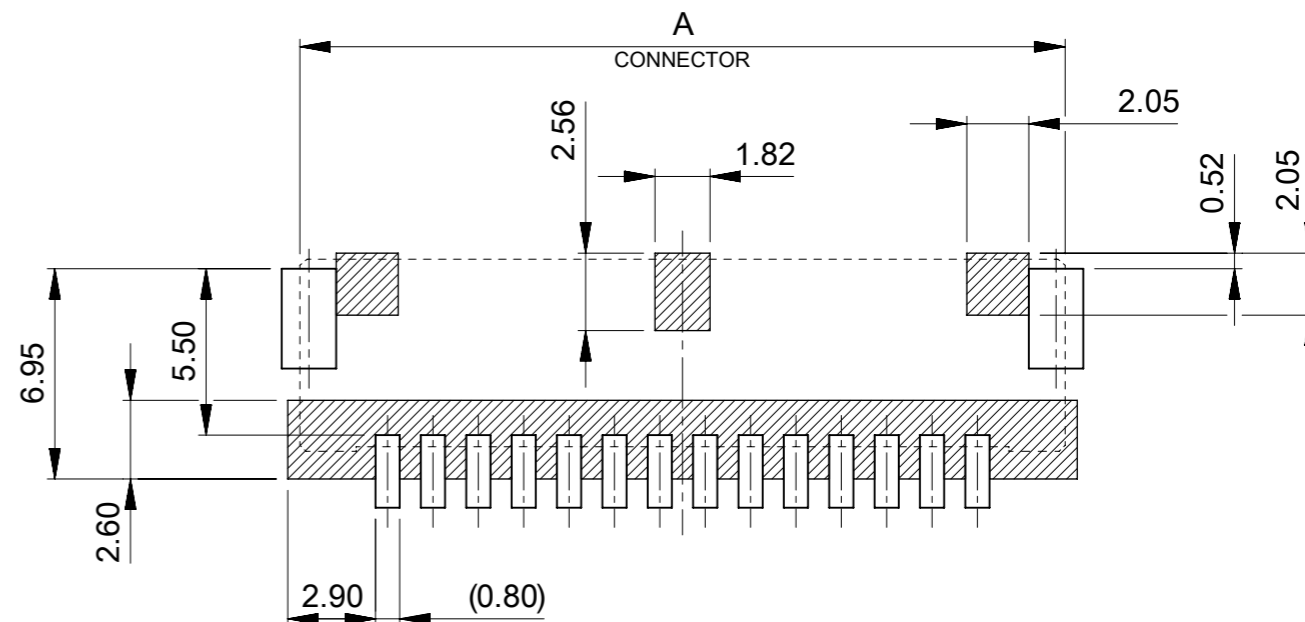

パターン非推奨エリア

パターンを引き回す際は、製品機能に影響がないことをご確認ください。  
PATTERN IS NOT RECCOMENDED ON THE HATCHED AREA.  
PLEASE CHECK NOT TO HAVE PROBLEM FOR PRODUCT FUNCTION  
WHEN SETTING PATTERN ON THE HATCHED AREA.

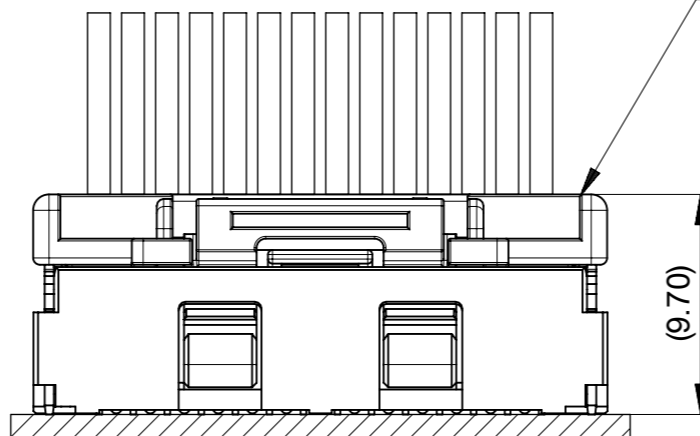
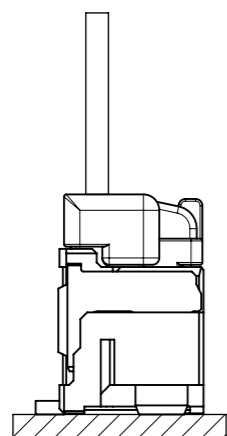

MATED CONNECTORS

嵌合相手 : 502578 シリーズ  
MATE WITH : 502578 SERIES

THIS DRAWING CONTAINS INFORMATION THAT IS PROPRIETARY TO MOLEX ELECTRONIC TECHNOLOGIES, LLC AND SHOULD NOT BE USED WITHOUT WRITTEN PERMISSION		CURRENT REV DESC:		<b>molex</b>	
DIMENSION UNITS	SCALE				
mm	NTS			CLIK-MATE 1.5 SINGLE ROW SMT VT TYPE REC ASSY GOLD PLATING	
GENERAL TOLERANCES (UNLESS SPECIFIED)				PRODUCT CUSTOMER DRAWING	
ANGULAR TOL	± 3.0 °			DOCUMENT NUMBER	
4 PLACES	± 0.2	EC NO: 742719		2132250000-SD	
3 PLACES	± 0.2	DRWN: MIKEDA01		DOC TYPE	
2 PLACES	± 0.2	CHK'D: SAKIYAMA		PSD	
1 PLACE	± 0.2	APPR: AIDA		DOC PART	
0 PLACES	± 0.2	INITIAL REVISION:		000	
DRAFT WHERE APPLICABLE MUST REMAIN WITHIN DIMENSIONS		DRWN: MIKEDA01		REVISION	
THIRD ANGLE PROJECTION		APPR: KOMURAKAMI		F	
DRAWING		SERIES		SHEET NUMBER	
A3-SIZE		213225		2 OF 6	
MATERIAL NUMBER		CUSTOMER			
GENERAL					

# ロック形状および吸着エリア LOCK SHAPE AND VACCUME AREA

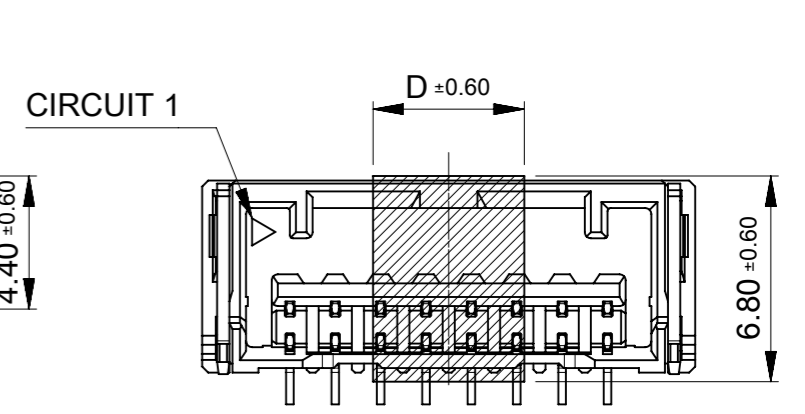
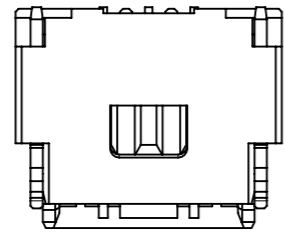

2 極  
2 CKTS

3 極  
3 CKTS

4-5 極  
4-5 CKTS

6, 7 極  
6, 7 CKTS

8-11 極  
8-11 CKTS

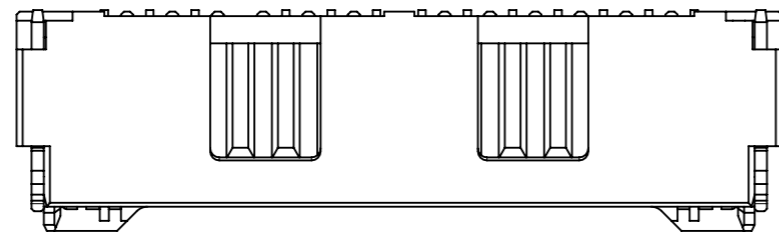

12-15 極  
12-15 CKTS

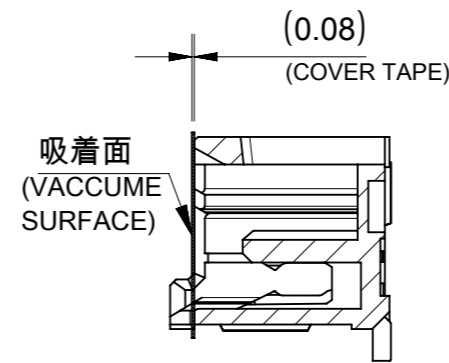

SECTION X-X

5.0	15
	14
	13
	12
	11
	10
	9
13.6	8
	7
	6
12.1	5
10.6	4
9.1	3
7.6	2
6.1	1
D	極数 CKT NO

THIS DRAWING CONTAINS INFORMATION THAT IS PROPRIETARY TO MOLEX ELECTRONIC TECHNOLOGIES, LLC AND SHOULD NOT BE USED WITHOUT WRITTEN PERMISSION		CURRENT REV DESC:		<b>molex</b>	
DIMENSION UNITS	SCALE				
mm	NTS			CLIK-MATE 1.5 SINGLE ROW SMT VT TYPE REC ASSY GOLD PLATING	
GENERAL TOLERANCES (UNLESS SPECIFIED)				PRODUCT CUSTOMER DRAWING	
ANGULAR TOL	± 3.0 °			DOCUMENT NUMBER	
4 PLACES	± 0.2	EC NO: 742719		2132250000-SD	
3 PLACES	± 0.2	DRWN: MIKEDA01		DOC TYPE	
2 PLACES	± 0.2	CHK'D: SAKIYAMA		PSD	
1 PLACE	± 0.2	APPR: AIDA		DOC PART	
0 PLACES	± 0.2	INITIAL REVISION:		000	
DRAFT WHERE APPLICABLE MUST REMAIN WITHIN DIMENSIONS		DRWN: MIKEDA01		REVISION	
THIRD ANGLE PROJECTION		APPR: KOMURAKAMI		F	
DRAWING		SERIES		SHEET NUMBER	
A3-SIZE		213225		3 OF 6	
MATERIAL NUMBER		CUSTOMER			
GENERAL					



NOTES

- 5. 梱包数量 : 900個/リール  
NUMBER OF CONNECTORS : 900 PIECES/REEL
  - 6. リードテープ長さ  
LEAD TAPE LENGTH
- 
- 7. トップテープの剥離強度はJIS C0806-3に準拠。  
TOP TAPE PEELING FORCE IS DEFINED BY JIS C0806-3.
  - 8. 本製品は乾燥剤入り、ハイバリア梱包である。  
THIS PRODUCT IS DELIVERD IN HIGH BARRIER PACKAGE WITH DESICCANT.

					15
					14
					13
					12
					11
					10
					9
					8
					7
					6
					5
					4
					3
					2
J	H	G	F	エンボステープ幅E WIDTH OF TAPE	極数 CKT. NO.

番号 NO.	部品 PART	材質 MATERIAL
④	エンボステープ EMBOSSSED TAPE	ポリスチレン(PS) POLYSTYRENE(PS)
⑤	トップテープ TOP TAPE	ポリエチレン、ポリエチレンテレフタレート POLYETHLENE(PE), POLYETHYLENE TEREPHTHALATE(PET)
⑥	リール REEL	ポリスチレン(PS) <リサイクル材を含む> POLYSTYRENE(PS) <RECYCLE MATERIAL CONTAINED>

THIS DRAWING CONTAINS INFORMATION THAT IS PROPRIETARY TO MOLEX ELECTRONIC TECHNOLOGIES, LLC AND SHOULD NOT BE USED WITHOUT WRITTEN PERMISSION

DIMENSION UNITS mm	SCALE NTS	CURRENT REV DESC:	
GENERAL TOLERANCES (UNLESS SPECIFIED)		<p><b>molex</b></p> <p>CLIK-MATE 1.5 SINGLE ROW SMT VT TYPE REC ASSY GOLD PLATING</p> <p>PRODUCT CUSTOMER DRAWING</p>	
ANGULAR TOL	± 3.0 °		
4 PLACES	± 0.2		
3 PLACES	± 0.2		
2 PLACES	± 0.2		
1 PLACE	± 0.2	<p>EC NO: 742719 DRWN: MIKEDA01 CHK'D: SAKIYAMA APPR: AIDA</p> <p>INITIAL REVISION: DRWN: MIKEDA01 APPR: KOMURAKAMI</p>	
0 PLACES	± 0.2	<p>2023/06/23 2023/06/23 2023/06/23</p>	
DRAFT WHERE APPLICABLE MUST REMAIN WITHIN DIMENSIONS		THIRD ANGLE PROJECTION	DRAWING A3-SIZE
		SERIES 213225	MATERIAL NUMBER 2132250000-SD
		CUSTOMER GENERAL	DOC TYPE PSD
			DOC PART 000
			REVISION F
			SHEET NUMBER 4 OF 6

△<sub>3</sub> 適用製品及び各種仕様書  
 APPLICABLE PRODUCTS AND VARIOUS SPECIFICATIONS

梱包仕様書 PACKAGING SPECIFICATION	PART NUMBER 213225 ****	DOCUMENT NUMBER 2132259200-SPK
----------------------------------	----------------------------	-----------------------------------

適用嵌合相手 MATE WITH	HOUSING	TERMINAL (GOLD PLATING)		
		PLATING THK	#24-28	#28-30
製品番号 PRODUCT NUMBER	502578 ****	0.1 micro-meters	213028 1*00	213029 1*00
		0.38 micro-meters	213028 3*00	213029 3*00
		0.76 micro-meters	213028 7*00	213029 7*00
製品仕様書 PRODUCT SPECIFICATION	5025780004-PS			
アプリケーション仕様書 APPLICATION SPECIFICATION	AS-502578-001			

THIS DRAWING CONTAINS INFORMATION THAT IS PROPRIETARY TO MOLEX ELECTRONIC TECHNOLOGIES, LLC AND SHOULD NOT BE USED WITHOUT WRITTEN PERMISSION													
DIMENSION UNITS	SCALE	CURRENT REV DESC:  EC NO: 742719 DRWN: MIKEDA01 2023/06/23 CHK'D: SAKIYAMA 2023/06/23 APPR: AIDA 2023/06/23				<b>molex</b>							
mm	NTS												
GENERAL TOLERANCES (UNLESS SPECIFIED)		INITIAL REVISION: DRWN: MIKEDA01 2019/11/07 APPR: KOMURAKAMI 2019/11/20				PRODUCT CUSTOMER DRAWING							
ANGULAR TOL	± 3.0 °					DOCUMENT NUMBER				DOC TYPE	DOC PART	REVISION	
4 PLACES	± 0.2					2132250000-SD				PSD	000	F	
3 PLACES	± 0.2					MATERIAL NUMBER				CUSTOMER			
2 PLACES	± 0.2												
1 PLACE	± 0.2	SERIES				SHEET NUMBER							
0 PLACES	± 0.2												
DRAFT WHERE APPLICABLE MUST REMAIN WITHIN DIMENSIONS		THIRD ANGLE PROJECTION	DRAWING	A3-SIZE	213225	GENERAL							

DOCUMENT STATUS	P1	RELEASE DATE	2023/06/23	10:36:34
-----------------	----	--------------	------------	----------

△ 製品一覧 PRODUCT LIST

黒 BLACK	ナチュラル NATURAL	HOUSING COLOR	
213225 1511	213225 1510	15	213225 **1* (GOLD PLATING THICKNESS: 0.1 micro-meters MIN)
213225 1411	213225 1410	14	
213225 1311	213225 1310	13	
213225 1211	213225 1210	12	
213225 1111	213225 1110	11	
213225 1011	213225 1010	10	
213225 0911	213225 0910	9	
213225 0811	213225 0810	8	
213225 0711	213225 0710	7	
213225 0611	213225 0610	6	
213225 0511	213225 0510	5	
213225 0411	213225 0410	4	
213225 0311	213225 0310	3	
213225 0211	213225 0210	2	
オーダー番号 ORDER No.		極数 CKT.	

黒 BLACK	ナチュラル NATURAL	HOUSING COLOR	
213225 1531	213225 1530	15	213225 **3* (GOLD PLATING THICKNESS: 0.38 micro-meters MIN)
213225 1431	213225 1430	14	
213225 1331	213225 1330	13	
213225 1231	213225 1230	12	
213225 1131	213225 1130	11	
213225 1031	213225 1030	10	
213225 0931	213225 0930	9	
213225 0831	213225 0830	8	
213225 0731	213225 0730	7	
213225 0631	213225 0630	6	
213225 0531	213225 0530	5	
213225 0431	213225 0430	4	
213225 0331	213225 0330	3	
213225 0231	213225 0230	2	
オーダー番号 ORDER No.		極数 CKT.	

黒 BLACK	ナチュラル NATURAL	HOUSING COLOR	
213225 1571	213225 1570	15	213225 **7* (GOLD PLATING THICKNESS: 0.76 micro-meters MIN)
213225 1471	213225 1470	14	
213225 1371	213225 1370	13	
213225 1271	213225 1270	12	
213225 1171	213225 1170	11	
213225 1071	213225 1070	10	
213225 0971	213225 0970	9	
213225 0871	213225 0870	8	
213225 0771	213225 0770	7	
213225 0671	213225 0670	6	
213225 0571	213225 0570	5	
213225 0471	213225 0470	4	
213225 0371	213225 0370	3	
213225 0271	213225 0270	2	
オーダー番号 ORDER No.		極数 CKT.	

THIS DRAWING CONTAINS INFORMATION THAT IS PROPRIETARY TO MOLEX ELECTRONIC TECHNOLOGIES, LLC AND SHOULD NOT BE USED WITHOUT WRITTEN PERMISSION													
DIMENSION UNITS		SCALE		CURRENT REV DESC:				<b>molex</b>					
mm		NTS											
GENERAL TOLERANCES (UNLESS SPECIFIED)				EC NO: 742719 DRWN: MIKEDA01 2023/06/23 CHK'D: SAKIYAMA 2023/06/23 APPR: AIDA 2023/06/23 INITIAL REVISION: DRWN: MIKEDA01 2019/11/07 APPR: KOMURAKAMI 2019/11/20				DOCUMENT NUMBER		DOC TYPE	DOC PART	REVISION	
ANGULAR TOL ± 3.0 °								2132250000-SD		PSD	000	F	
4 PLACES ± 0.2													
3 PLACES ± 0.2													
2 PLACES ± 0.2													
1 PLACE ± 0.2													
0 PLACES ± 0.2													
DRAFT WHERE APPLICABLE MUST REMAIN WITHIN DIMENSIONS				THIRD ANGLE PROJECTION		DRAWING	SERIES	MATERIAL NUMBER	CUSTOMER	SHEET NUMBER			
						A3-SIZE	213225		GENERAL	6 OF 6			