

AUXILIARY ACTUATORS FOR BASIC SWITCHES

BUSHING MOUNT PUSHBUTTONS FOR OTTO B2 & B3 BASICS

IP68S Sealed Construction



P4 series auxiliary actuators are designed to work with OTTO B2 (single break) and B3 (double break) basic switches. Auxiliary type actuators offer a wide variety of styles and types. Special basic switch characteristics can be specified to match your application needs. All case styles, except 1 and 4, feature OTTO's patented "rolling sleeve" principle and are sealed to IP68S.

Number of Poles	Operating Force (oz)	Release Force (oz)
1	8	2
2	16	2
3	24	3
4	32	4

Unsealed Construction



These unsealed pushbutton actuators feature a choice of 1/4" and 15/32" mounting bushings with nylon buttons available in nine colors. Choose single, two, three and four pole models. To order standard models, use the Part Number Code shown below.

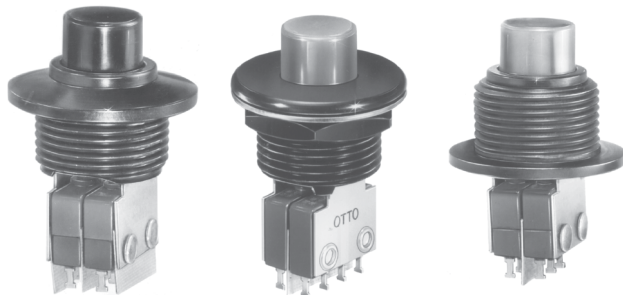
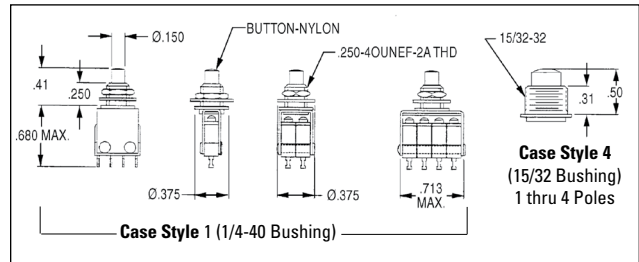

Sealed Construction

Moistureproof at the front panel. Choice of one and two pole configurations. Select from a variety of six bezel/bushing mount case styles in clear (silver) or black anodized aluminum. Styles C, H and F are illustrated here. For styles A, B and G, see P1 series information. Buttons are available in nine colors. Basic switches are per MIL-PRF-8805/101.

Operating Force: 4.0 lbs. max

Use Part Number Code below to specify your requirements.

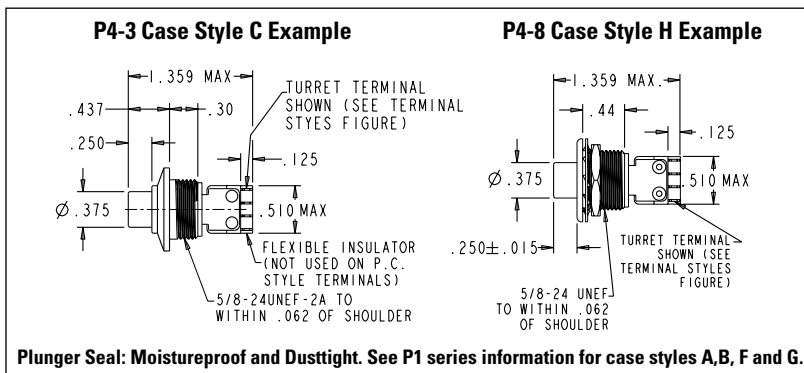

RFI Shielding Option with Moistureproof Panel Seal

RFI shielding can be included along with the moistureproof sealing feature in all case styles (except styles 1 and 4) and in single or double pole momentary action. Case styles are illustrated at left. The plunger seal is dusttight and moistureproof. Basic switches per MIL-PRF-8805/101.

Operating Force: 5.0 lbs. max

To order, see Part Number Code below.

ORDERING INFORMATION:

Standard Auxiliary Actuator Assemblies for Basics

Select the OTTO P4 pushbutton switch assembly to match your specific application needs. Standard and special features are shown at right. Specify your choice by building the OTTO Part Number Code.

Example: P4-614121 features the style "F" case, DPDT (4 terminals each), PC terminals, single step momentary action, black bezel with red button.

P4 PART NUMBER CODE

P4	X	X	X	X	X	X
Case Style	Terminal Style	Circuit Form	Switching Action	Bezel Color	Button Color	
1. 1/4-40 THD	1. PC Terminal	1. SPDT 3 Terminal	1. Momentary	1. Silver	1. Red	
2. Style B ①	2. Turret	2. SPDT 4 Terminal	2. Two Step ③ ④	2. Black	2. Black	
3. Style C	3. Wire Wrap	3. DPDT 6 Terminal	3. RFI Shielded ③		3. Orange	
4. 15/32-32 THD		4. DPDT 8 Terminal	(Momentary)		4. Yellow	
5. Style A ①		5. 3PDT 9 Terminal ②			5. Green	
6. Style F		6. 3PDT 12 Terminal ②			6. Blue	
7. Style G ①		7. 4PDT 12 Terminal ②			7. Purple	
8. Style H		8. 4PDT 16 Terminal ②			8. Gray	
					9. White	

① See P1 Series information for front panel appearance details.
 ② Available in case styles 1 and 4 only.
 ③ Not available in case styles 1 and 4.
 ④ Available in circuit form 3 and 4 only.

BUSHING MOUNT PUSHBUTTONS FOR B2 & B3 BASICS



P4-10050-x

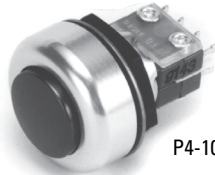

P4-10149-x

Rugged Sealed Panel

These rugged, sealed aluminum pushbutton actuators are anodized in a variety of colors. Available in one and two pole models. An O-ring provides the panel seal to keep out water and dust from the basic switches behind the panel.

Operating Force:

1 Pole: 2.5 lbs. max
2 Pole: 4.0 lbs.

To order, please use Table A.

Table A

Part No. SPDT-DB	Part No. DPDT-DB	Button Color
P4-10050-1	P4-10149-1	Red
P4-10050-2	P4-10149-2	Black
N/A	P4-10149-3	Orange
N/A	P4-10149-4	Yellow
N/A	P4-10149-6	Blue
N/A	P4-10149-7	Purple
N/A	P4-10149-9	Clear

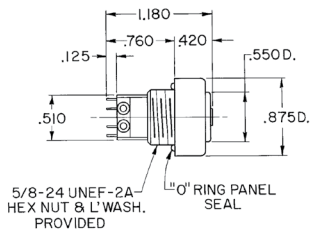

P4-10050-X

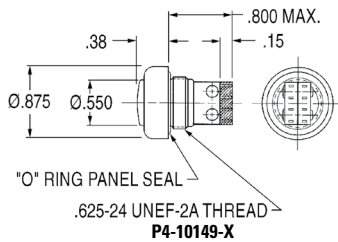

P4-10149-X

Standard Sealed TwoStep™

Ideal for applications requiring three modes of operation: "OFF," Level 1 and Level 2. Plunger seal is dusttight and moistureproof. Available in P1 series bezel styles C, F and H. Two pole only.

Standard Operating Force:

Position 1: 2.25 lbs. max
Position 2: 3.25 lbs. max

Total Travel: 0.140 inches max



Sequence of Action

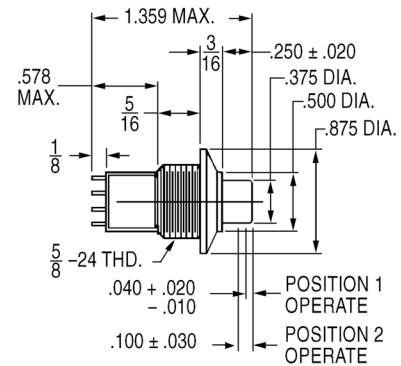
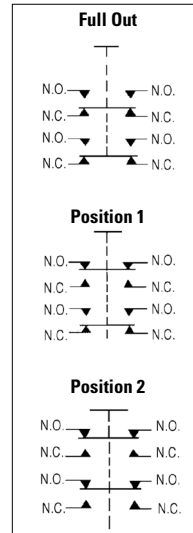

Miniature, Offset Pushbutton

This miniature switch features an offset pushbutton to clear back of panel interference, stainless steel bushing and natural acetal button.

Operating Force: 8 oz max
Circuit: SPDT
Rating: 1 amp Resistive
Mechanical Life: 50,000 cycles
Electrical Life: 25,000 cycles
P4-900027

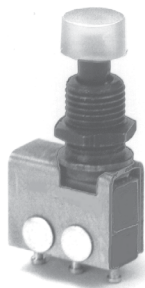

Special TwoStep™ Pushbutton, Dusttight Sealed

Switch "A" operates at Level 1; stays "on" when Level 2 operates Switch "B".

Circuit: SPDT 2 circuit
Rating: 5 amps Resistive
3 amps Inductive @ 28VDC
Operating Force: Level 1: 1.75 +/- 0.5 lb.
Level 2: 2.75 +/- 0.5 lb.
Button: Red nylon
P4-20002



Style F, Panel Sealed, 2 Pole

Moistureproof and dusttight sealed switch features the "F" style bezel, as illustrated on previous page. Button is molded of gray nylon.

Total Travel: 0.100" max
Operating Force: 4.0 lbs. +/- 1.0 lb.
Circuit: DPNO-DB
Rating: 10 amps Resistive
5 amps Inductive
Mechanical Life: 50,000 cycles
Electrical Life: 25,000 cycles
P4-600009



Splash and Dusttight Sealed, 2 Pole, 4 Circuit

Operating Force: 4.0 lbs. +/- 1.0 lb.
Circuit: DPDT 4 circuit
Rating: 5 amps Resistive
3 amps Inductive
Contacts: Gold plate per MIL-PRF-8805/101-010
Button: Black nylon
P4-100044



BUSHING MOUNT PUSHBUTTONS FOR B2 & B3 BASICS

Square Button, Single Pole, 2 Circuit

This subminiature pushbutton switch features a button molded of Lexan.

Operating Force: 24 +/- 4 oz

Rating: 5 amps Resistive
3 amps Inductive

Contacts: Gold plate

White and other colors available.

P4-300015



Vandal Resistant

Brass plated dull nickel housing and button is watertight sealed. Ideal for unattended machines operated by the public.

Total Travel: 0.10" max

Operating Force: 4.0 lbs. max

Circuit: DPNO-DB

Mechanical Life: 250,000 cycles

Bezel: 0.969" dia.

Button: 0.600" dia.

P4-10155-2

For larger 1.5" dia., SPNO-DB design, see P1-90135-2.



Watertight Panel Sealed Double Pole

Dress ring has O-ring provision for watertight panel seal. Button and case are black. Switch uses MIL-PRF-8805/101 basics. Seal is watertight. Operating force is 4.0 lbs.

P4-900003



1/4-40 Bushing, SPDT 2 Circuit

This subminiature pushbutton switch features an anti-turn device to facilitate installation.

Operating Force: 10 oz max

Rating: 8 amps Resistive @ 28VDC

Bushing: Stainless steel

Bracket: Stainless steel

Button: Nylon

P4-10029

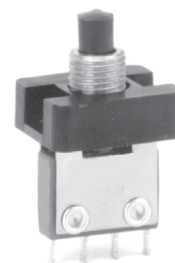

6 Pole, Right Angle, PC Mount

Solders into printed circuit board. Basic switches per MIL-PRF-8805/4.

Operating Force: 3.5 lbs. max

Rating: 1 amp Resistive

Contacts: Gold

Button Color: Choice of nine colors

P4-10073-X

(X denotes button color)



2 Pole, Right Angle, Bushing Mount—Single and TwoStep™ Versions

Right angle bushing mount assembly of basic switches. Either 2-mode momentary or 3-mode TwoStep™ (OFF-Level 1-Level 2) action.

Operating Force: 24 +/- 4 oz

Rating: 8 amps Resistive

Plunger: Red nylon (Other colors available)

Bushing: Stainless steel

Single Level: P4-10022

TwoStep™: P4-20003

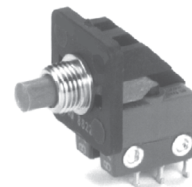

8 Pole, Positive Detent, Sealed

Circuit: 8 PDT

Rating: 1 amp Resistive
0.5 amps Inductive

Bracket: Stainless steel

Bushing: Aluminum black anodized

Button: Nylon, choice of nine colors

P4-10082-X

(X denotes button color)



Shroud Protected Button, 2 Pole

Button is protected against accidental actuation by a black anodized shroud.

Operating Force: 4.0 lbs. +/- 1.0 lb.

Rating: 5 amps Resistive
2 amps Inductive @ 28VDC

Button: Red nylon

P4-900013



Miniature with Shrouded Pushbutton, Unsealed

Total Travel: 0.070" max

Operating Force: 2.5 lbs. max

Circuit: DPDT-DB

Rating: 8 amps Resistive @ 28VDC

Button: Black nylon

Housing: Clear anodized aluminum

Plunger: Unsealed

P4-10090

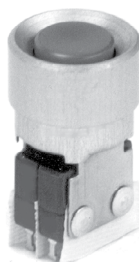

Miniature with Shrouded Pushbutton, Dusttight Sealed

Total Travel: 0.100" max

Operating Force: 4.0 lbs. max

Circuit: DPDT-DB

Rating: 8 amps Resistive @ 28VDC

Button: Black nylon

Housing: Black anodized aluminum

Plunger: Dusttight sealed

P4-900019



Mouser Electronics

Authorized Distributor

Click to View Pricing, Inventory, Delivery & Lifecycle Information:

OTTO:

[P4-900014](#) [P4-823125](#) [P4-822122](#) [P4-821121](#) [P4-334121](#) [P4-723112](#) [P4-733111](#) [P4-333222](#) [P4-824221](#) [P4-824222](#) [P4-323226](#) [P4-333122](#) [P4-423121](#) [P4-424121](#) [P4-514121](#) [P4-723124](#) [P4-426123](#) [P4-426128](#) [P4-124111](#) [P4-223222](#) [P4-313111](#) [P4-313222](#) [P4-522121](#) [P4-621311](#) [P4-624222](#) [P4-624321](#) [P4-724122](#) [P4-824129](#) [P4-724228](#) [P4-821112](#) [P4-423122](#) [P4-427122](#) [P4-428112](#) [P4-428121](#) [P4-623221](#) [P4-633221](#) [P4-723113](#) [P4-723115](#) [P4-723123](#) [P4-723127](#) [P4-424128](#) [P4-425112](#) [P4-428122](#) [P4-633121](#) [P4-421128](#) [P4-613121](#) [P4-523221](#) [P4-624221](#) [P4-123112](#) [P4-124112](#) [P4-334221](#) [P4-423124](#) [P4-122111](#) [P4-314221](#) [P4-323321](#) [P4-421111](#) [P4-421121](#) [P4-522128](#) [P4-113125](#) [P4-122112](#) [P4-128122](#) [P4-224122](#) [P4-224128](#) [P4-723129](#) [P4-724121](#) [P4-124122](#) [P4-321121](#) [P4-323121](#) [P4-323222](#) [P4-523122](#) [P4-623121](#) [P4-624122](#) [P4-634128](#) [P4-723119](#) [P4-723125](#) [P4-123122](#) [P4-426122](#) [P4-427125](#) [P4-436118](#) [P4-514128](#) [P4-425124](#) [P4-523328](#) [P4-614122](#) [P4-614221](#) [P4-621321](#) [P4-723122](#) [P4-824111](#) [P4-824122](#) [P4-122122](#) [P4-125121](#) [P4-333221](#) [P4-423129](#) [P4-734111](#) [P4-821111](#) [P4-823112](#) [P4-823222](#) [P4-814221](#) [P4-823221](#) [P4-524222](#) [P4-531111](#)