

Surface Mount Low Pass Filter

SXLP-16+

50Ω DC to 16 MHz

The Big Deal

- Low Insertion Loss typical 0.5 dB
- Sharp roll-off
- Wide band rejection till 2200 MHz
- Very good VSWR typical 1.3:1
- Miniature shielded package

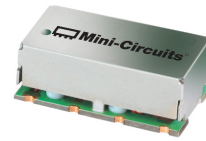

Generic photo used for illustration purposes only
CASE STYLE: HF1139

Product Overview

The SXLP-16+ is a lowpass filter in a shielded package (size of 0.440" x 0.740" x 0.270") fabricated using SMT technology. Covering DC to 16 MHz band width, these units offer good matching within the passband and high rejection typical 40 dB. This model uses a miniature high Q capacitors and wire welded inductors for high reliability. In addition it has repeatable performance across production lots and consistent performance across temperature.

Key Features

Feature	Advantages
Sharp roll-off	Sharp roll-off, this will attenuate frequencies closer to the passband with good rejection.
Good ultimate rejection	This enables the filters to attenuate spurious signals and reject harmonics for broadband frequency.
Small size, 0.440" x 0.740" x 0.270"	The small surface mount package enables the SXLP-16+ to be used in compact designs.

Notes

- A. Performance and quality attributes and conditions not expressly stated in this specification document are intended to be excluded and do not form a part of this specification document.
B. Electrical specifications and performance data contained in this specification document are based on Mini-Circuit's applicable established test performance criteria and measurement instructions.
C. The parts covered by this specification document are subject to Mini-Circuits standard limited warranty and terms and conditions (collectively, "Standard Terms"); Purchasers of this part are entitled to the rights and benefits contained therein. For a full statement of the Standard Terms and the exclusive rights and remedies thereunder, please visit Mini-Circuits' website at www.minicircuits.com/MCLStore/terms.jsp



Surface Mount Low Pass Filter

SXLP-16+

50Ω DC to 16 MHz

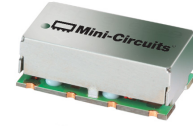

Generic photo used for illustration purposes only
CASE STYLE: HF1139

Features

- Low Insertion Loss typical 0.5dB
- Sharp roll-off
- Wide band rejection till 2200 MHz
- Very good VSWR typical 1.3:1
- Miniature shielded package

Applications

- Defense system
- Test and measurement

Electrical Specifications at 25°C

Parameter	F#	Frequency (MHz)	Min.	Typ.	Max.	Unit	
Pass Band	Insertion Loss	DC-F1	—	0.5	1.2	dB	
	Freq. Cut-Off	F2	—	3.0	—	dB	
	VSWR	DC-F1	DC-16	—	1.3	1.6	:1
Stop Band	Rejection Loss	F3	20	30	—	dB	
		F4-F5	50-1000	—	40	—	dB
		F5-F6	1000-2200	—	30	—	dB
	VSWR	F3-F6	22-2200	—	20	—	:1

Maximum Ratings

Operating Temperature	-40°C to 85°C
Storage Temperature	-55°C to 100°C
RF Power Input	0.5 W max.

Permanent damage may occur if any of these limits are exceeded.

Functional Schematic

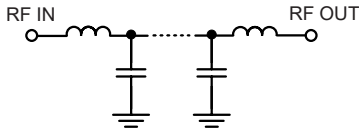

Typical Frequency Response

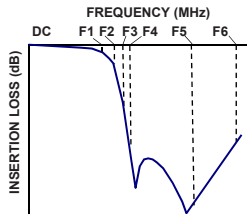

Typical Performance Data at 25°C

Frequency (MHz)	Insertion Loss (dB)	VSWR (:1)	Frequency (MHz)	Group Delay (nsec)
1.00	0.10	1.04	1.00	33.11
5.00	0.15	1.12	1.50	33.33
16.00	0.41	1.20	2.00	33.25
18.30	1.46	2.05	2.50	33.31
18.50	2.02	2.60	3.00	33.46
18.80	3.30	3.93	4.00	33.88
19.60	9.26	13.33	5.00	34.50
20.00	13.05	21.81	6.00	35.34
20.70	20.29	37.62	7.00	36.42
21.50	29.89	51.01	8.00	37.74
22.00	37.95	57.34	9.00	39.31
50.00	46.39	145.83	10.00	41.25
100.00	65.98	288.30	10.50	42.34
250.00	107.94	410.61	11.00	43.55
500.00	98.05	400.44	11.50	44.97
750.00	93.45	195.17	12.00	46.61
1000.00	69.26	72.51	12.50	48.45
1500.00	53.81	5.81	13.00	50.67
2000.00	44.17	4.19	14.00	56.28
2200.00	53.48	10.11	16.00	75.59

+RoHS Compliant

The +Suffix identifies RoHS Compliance. See our web site for RoHS Compliance methodologies and qualifications

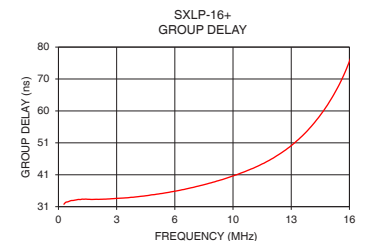
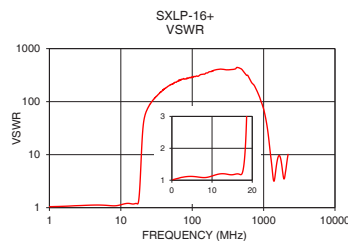
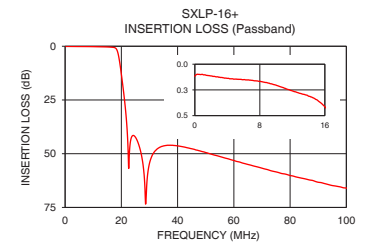
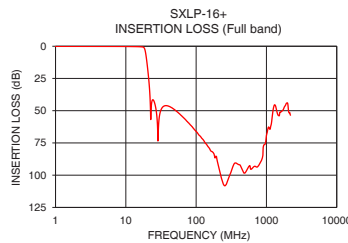

Notes

- Performance and quality attributes and conditions not expressly stated in this specification document are intended to be excluded and do not form a part of this specification document.
- Electrical specifications and performance data contained in this specification document are based on Mini-Circuits' applicable established test performance criteria and measurement instructions.
- The parts covered by this specification document are subject to Mini-Circuits standard limited warranty and terms and conditions (collectively, "Standard Terms"); Purchasers of this part are entitled to the rights and benefits contained therein. For a full statement of the Standard Terms and the exclusive rights and remedies thereunder, please visit Mini-Circuits' website at www.minicircuits.com/MCLStore/terms.jsp



www.minicircuits.com P.O. Box 350166, Brooklyn, NY 11235-0003 (718) 934-4500 sales@minicircuits.com

REV. A
ECO-005139
SXLP-16+
EDU1989
URJ
201202
Page 2 of 3

Pad Connections

INPUT	1
OUTPUT	8
GROUND	2,3,4,5,6,7

Demo Board MCL P/N: TB-368+ Suggested PCB Layout (PL-230)

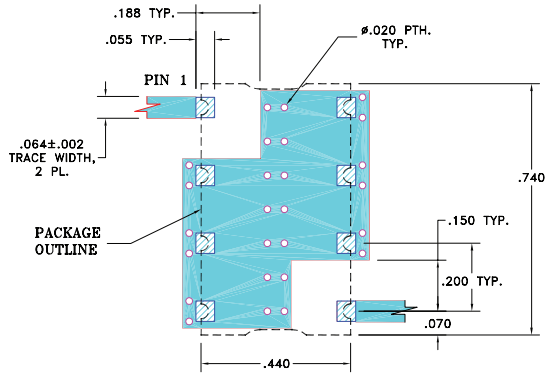

NOTE:

- TRACE WIDTH IS SHOWN FOR FR4 WITH DIELECTRIC THICKNESS: .025"±.002". COPPER: 1/2 OZ. EACH SIDE. FOR OTHER MATERIALS TRACE WIDTH MAY NEED TO BE MODIFIED.
- BOTTOM SIDE OF THE PCB IS CONTINUOUS GROUND PLANE.

- DENOTES PCB COPPER LAYOUT WITH SMOBC (SOLDER MASK OVER BARE COPPER)
- DENOTES COPPER LAND PATTERN FREE OF SOLDER MASK

Outline Drawing

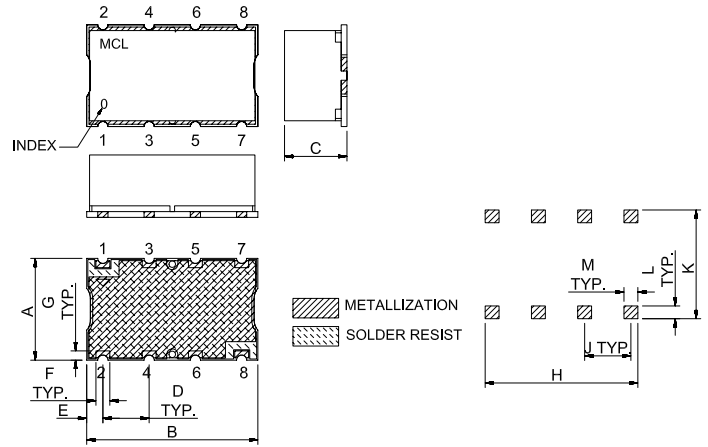

Outline Dimensions (Inch/mm)

A	B	C	D	E	F	G
.44	.74	.27	.200	.07	.060	.040
11.18	18.80	6.86	5.08	1.78	1.52	1.02
H	J	K	L	M	wt	
.660	.200	.470	.055	.060	grams	
16.76	5.08	11.94	1.40	1.52	3.0	

Note: Please refer to case style drawing for details

Notes

- Performance and quality attributes and conditions not expressly stated in this specification document are intended to be excluded and do not form a part of this specification document.
- Electrical specifications and performance data contained in this specification document are based on Mini-Circuit's applicable established test performance criteria and measurement instructions.
- The parts covered by this specification document are subject to Mini-Circuits standard limited warranty and terms and conditions (collectively, "Standard Terms"); Purchasers of this part are entitled to the rights and benefits contained therein. For a full statement of the Standard Terms and the exclusive rights and remedies thereunder, please visit Mini-Circuits' website at www.minicircuits.com/MCLStore/terms.jsp

Typical Performance Data

FREQ. (MHz)	INSERTION LOSS			INPUT RETURN LOSS			OUTPUT RETURN LOSS		
	(dB)			(dB)			(dB)		
	@-40°C	@+25°C	@+85°C	@-40°C	@+25°C	@+85°C	@-40°C	@+25°C	@+85°C
1.00	0.09	0.10	0.11	33.76	33.54	33.40	33.69	33.44	33.29
3.00	0.11	0.12	0.13	26.56	26.31	26.16	26.43	26.15	25.98
5.00	0.13	0.15	0.15	25.24	25.00	24.85	24.80	24.52	24.35
10.00	0.19	0.20	0.21	24.19	24.14	24.13	23.50	23.47	23.42
12.00	0.24	0.26	0.27	20.97	20.86	20.80	20.74	20.66	20.60
14.00	0.29	0.31	0.33	21.66	21.56	21.52	21.48	21.43	21.38
16.00	0.39	0.41	0.44	20.97	21.01	21.09	21.24	21.32	21.42
17.00	0.48	0.51	0.55	21.79	21.74	21.77	23.98	24.14	24.47
18.00	0.88	0.96	1.03	13.53	13.18	12.94	14.42	14.12	13.92
18.20	1.16	1.26	1.34	10.76	10.47	10.28	11.28	11.04	10.88
18.40	1.60	1.71	1.82	8.33	8.10	7.95	8.66	8.46	8.34
18.60	2.23	2.38	2.51	6.29	6.11	6.00	6.50	6.35	6.26
18.80	3.12	3.30	3.45	4.64	4.51	4.44	4.79	4.68	4.62
19.00	4.26	4.48	4.65	3.37	3.29	3.24	3.47	3.41	3.37
20.00	12.74	13.05	13.28	0.79	0.80	0.81	0.81	0.82	0.85
20.50	17.81	18.15	18.39	0.51	0.52	0.54	0.51	0.53	0.56
20.60	18.86	19.21	19.45	0.47	0.49	0.51	0.48	0.50	0.53
20.70	19.93	20.29	20.54	0.44	0.46	0.48	0.45	0.47	0.50
20.80	21.02	21.38	21.64	0.42	0.44	0.46	0.42	0.45	0.47
20.90	22.13	22.50	22.76	0.40	0.42	0.43	0.40	0.43	0.45
21.00	23.26	23.65	23.91	0.39	0.40	0.42	0.38	0.41	0.43
21.20	25.61	26.02	26.30	0.36	0.37	0.39	0.35	0.38	0.40
21.40	28.11	28.55	28.85	0.33	0.35	0.36	0.33	0.35	0.37
21.60	30.81	31.30	31.63	0.31	0.33	0.35	0.31	0.33	0.35
21.80	33.80	34.36	34.74	0.30	0.31	0.33	0.30	0.32	0.34
22.00	37.27	37.95	38.40	0.29	0.30	0.32	0.28	0.30	0.32
23.00	47.52	46.92	46.57	0.24	0.26	0.27	0.24	0.26	0.27
24.00	41.63	41.60	41.64	0.22	0.23	0.24	0.21	0.23	0.24
25.00	42.26	42.35	42.44	0.20	0.20	0.22	0.19	0.21	0.22
26.00	44.98	45.14	45.30	0.18	0.19	0.20	0.18	0.19	0.20
30.00	54.68	54.47	54.29	0.14	0.15	0.15	0.14	0.15	0.16
50.00	49.41	49.48	49.47	0.08	0.08	0.09	0.08	0.08	0.09
75.00	58.45	58.48	58.41	0.06	0.06	0.07	0.06	0.07	0.07
100.00	66.00	65.98	65.96	0.05	0.06	0.07	0.05	0.06	0.06
150.00	77.88	78.33	78.50	0.04	0.05	0.06	0.04	0.05	0.05
200.00	91.72	89.14	89.55	0.02	0.04	0.05	0.02	0.04	0.05
250.00	94.93	107.94	101.64	0.01	0.04	0.05	0.02	0.04	0.05
500.00	94.50	98.05	96.77	0.00	0.04	0.06	0.00	0.04	0.06
600.00	96.18	95.48	98.98	0.00	0.06	0.08	0.00	0.05	0.07
700.00	85.63	87.75	84.70	0.01	0.08	0.11	0.02	0.07	0.10
800.00	84.35	83.59	86.68	0.03	0.11	0.15	0.04	0.10	0.14
900.00	79.92	78.29	79.08	0.07	0.16	0.21	0.08	0.16	0.20
1000.00	70.37	69.26	69.08	0.12	0.24	0.31	0.16	0.26	0.33
1100.00	62.87	63.68	64.02	0.27	0.44	0.56	0.38	0.53	0.65
1200.00	58.76	56.06	55.11	0.74	1.07	1.28	1.05	1.46	1.74
1300.00	44.37	45.46	46.67	2.18	2.76	3.14	5.01	6.03	6.12
1400.00	47.57	50.07	51.28	5.93	5.72	5.22	4.33	3.57	3.33
1500.00	53.75	53.81	53.90	3.37	3.02	2.85	1.57	1.51	1.54
1600.00	51.28	51.08	51.09	1.84	1.92	1.97	0.93	1.00	1.06
1700.00	50.05	49.95	49.92	1.63	1.90	2.05	0.75	0.86	0.94
1800.00	47.52	47.05	47.08	2.27	2.83	3.07	0.76	0.92	1.02
1825.00	46.98	46.61	46.56	2.63	3.28	3.52	0.80	0.96	1.07
1850.00	46.27	46.06	46.27	3.11	3.81	4.03	0.84	1.03	1.14
1900.00	44.59	44.76	45.10	4.31	4.87	4.92	0.98	1.20	1.34
1925.00	43.83	44.22	44.69	4.88	5.14	5.08	1.09	1.32	1.48
1950.00	43.42	44.08	44.49	5.21	5.09	4.95	1.22	1.48	1.64
2000.00	43.24	44.17	44.72	4.71	4.22	4.11	1.56	1.87	2.04
2025.00	44.45	45.80	46.47	4.18	3.75	3.68	1.79	2.10	2.27
2100.00	50.15	51.63	52.33	2.89	2.63	2.65	2.54	2.74	2.79
2200.00	51.54	53.48	54.20	1.76	1.72	1.77	2.71	2.56	2.50



P.O. Box 350166, Brooklyn, New York 11235-0003 (718) 934-4500 • Fax (718) 332-4661 For detailed performance specs & shopping online see Mini-Circuits web site

The Design Engineers Search Engine Provides ACTUAL Data Instantly From MINI-CIRCUITS At: www.minicircuits.com

IF/RF MICROWAVE COMPONENTS

Typical Performance Data

FREQ. (MHz)	GROUP DELAY		
	(nsec)		
	@-40°C	@+25°C	@+85°C
0.30	31.05	31.75	31.43
0.50	32.27	32.46	32.44
1.00	33.03	33.11	33.12
1.20	33.13	33.18	33.25
1.40	33.18	33.28	33.28
1.60	33.19	33.27	33.32
1.80	33.10	33.22	33.22
2.00	33.19	33.25	33.32
2.50	33.28	33.31	33.36
3.00	33.47	33.46	33.51
3.50	33.62	33.63	33.67
4.00	33.82	33.88	33.88
4.50	34.09	34.16	34.18
5.00	34.46	34.50	34.54
5.50	34.86	34.89	34.93
6.00	35.31	35.34	35.37
6.50	35.80	35.84	35.87
7.00	36.35	36.42	36.45
7.50	37.00	37.05	37.10
8.00	37.67	37.74	37.81
8.50	38.43	38.51	38.56
9.00	39.24	39.31	39.37
9.50	40.15	40.26	40.30
10.00	41.16	41.25	41.30
11.00	43.43	43.55	43.61
11.50	44.86	44.97	45.03
12.00	46.49	46.61	46.67
13.00	50.53	50.67	50.75
14.00	56.11	56.28	56.42
15.00	63.77	64.09	64.27
16.00	75.16	75.59	75.93

Typical Performance Curves

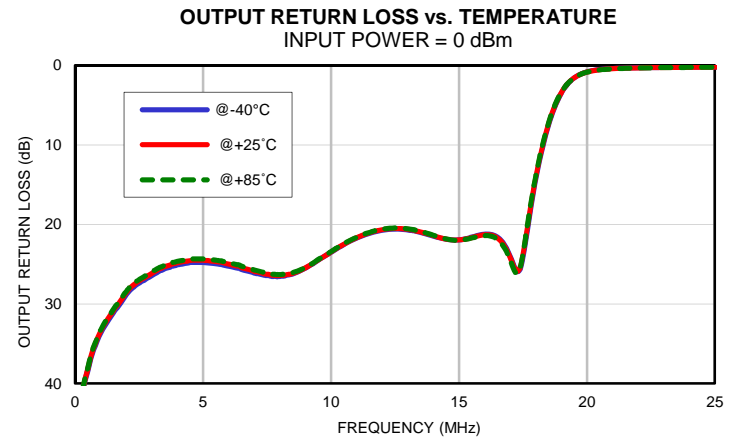
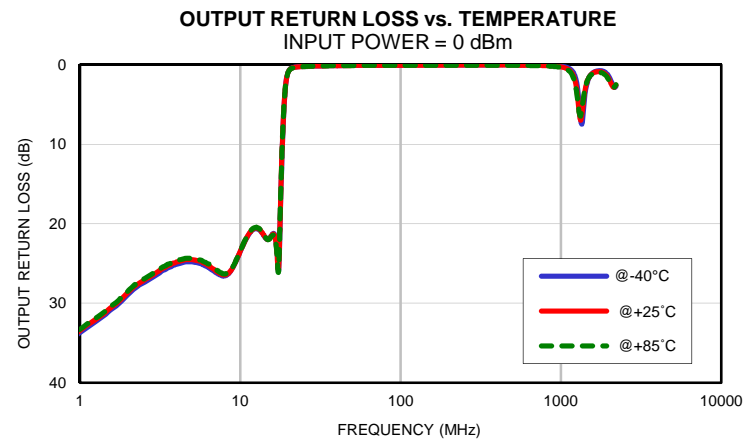
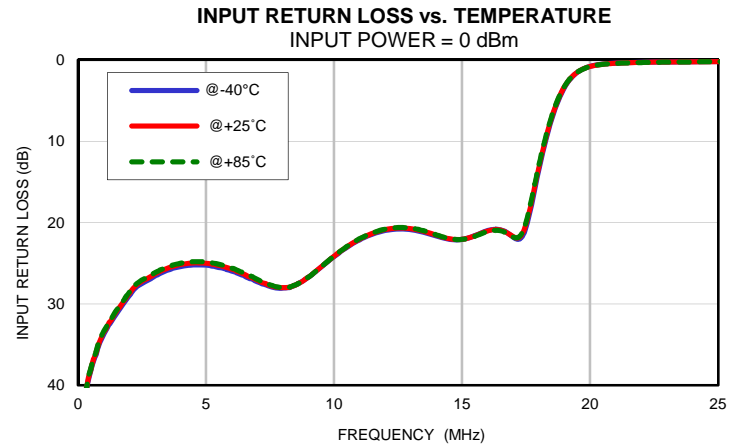
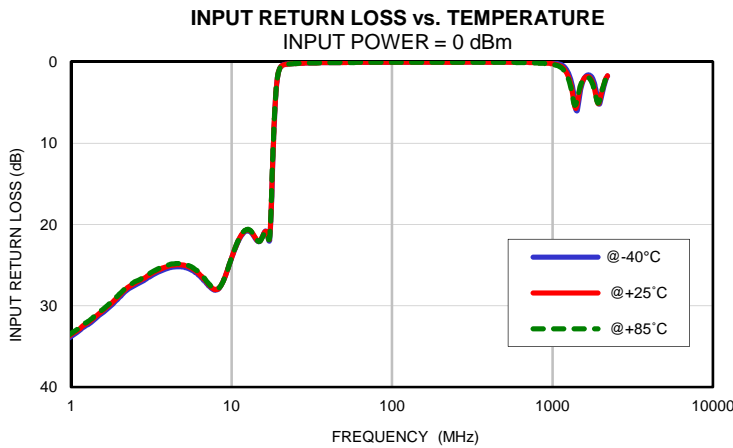
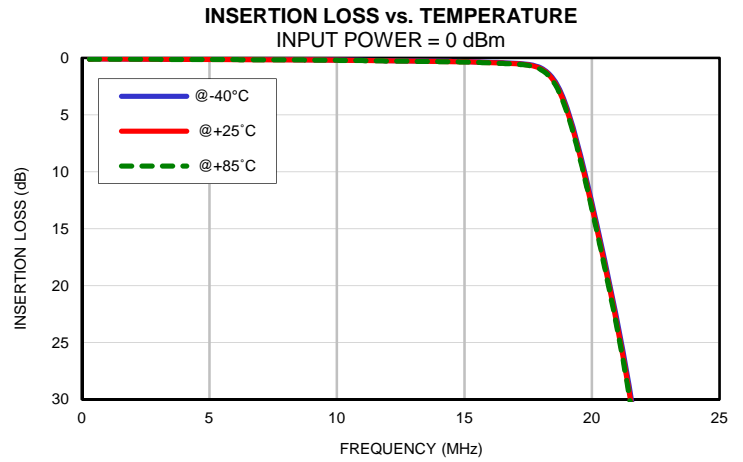
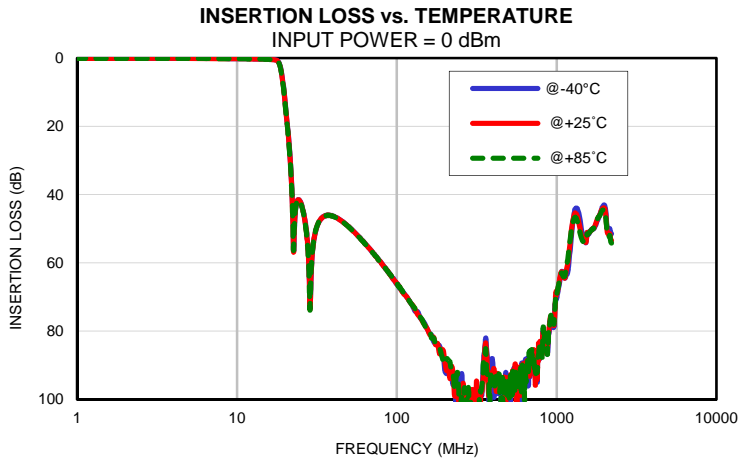

Typical Performance Curves

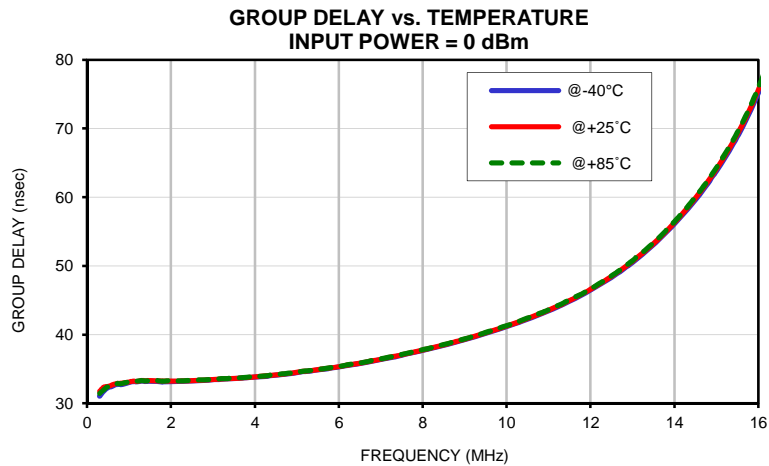

Outline Dimensions

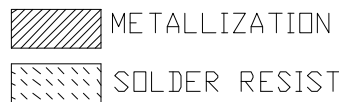
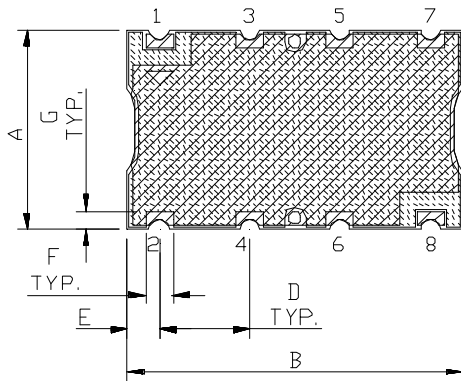
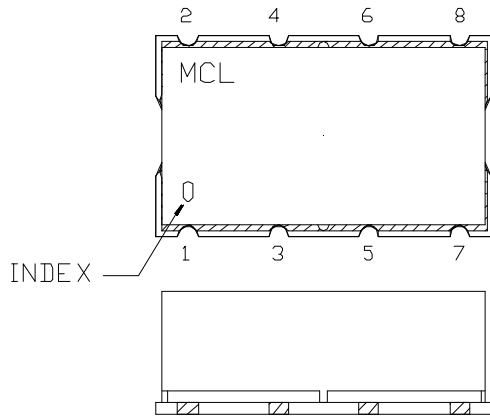

PCB Land Pattern

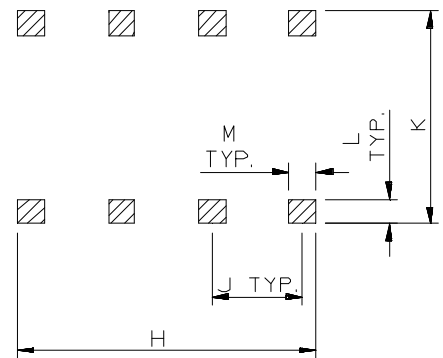

CASE #	A	B	C	D	E	F	G	H	J	K	L	M	WT. GRAMS
HF1139	.44 (11.18)	.74 (18.80)	.27 (6.86)	.200 (5.08)	.07 (1.78)	.060 (1.52)	.040 (1.02)	.660 (16.76)	.200 (5.08)	.470 (11.94)	.055 (1.40)	.060 (1.52)	3.0

Dimensions are in inches (mm). Tolerances: 2 Pl. ± 0.015 "; 3 Pl. ± 0.01 "

Notes:

- Case material: Nickel-Silver alloy.
- Base: Printed wiring laminate.
- Termination finish:
 - For RoHS Case Styles: 2-5 μ inch (.05-.13 microns) Gold over 120-240 μ inch (3.05-6.10 microns) Nickel plate.
 - For RoHS-5 Case Styles: Tin-Lead plate.



P.O. Box 350166, Brooklyn, New York 11235-0003 (718) 934-4500 Fax (718) 332-4661 For detailed performance specs & shopping online see Mini-Circuits web site



The Design Engineers Search Engine Provides ACTUAL Data Instantly From MINI-CIRCUITS At: www.minicircuits.com

RFIIF MICROWAVE COMPONENTS

Tape & Reel Packaging TR-F5

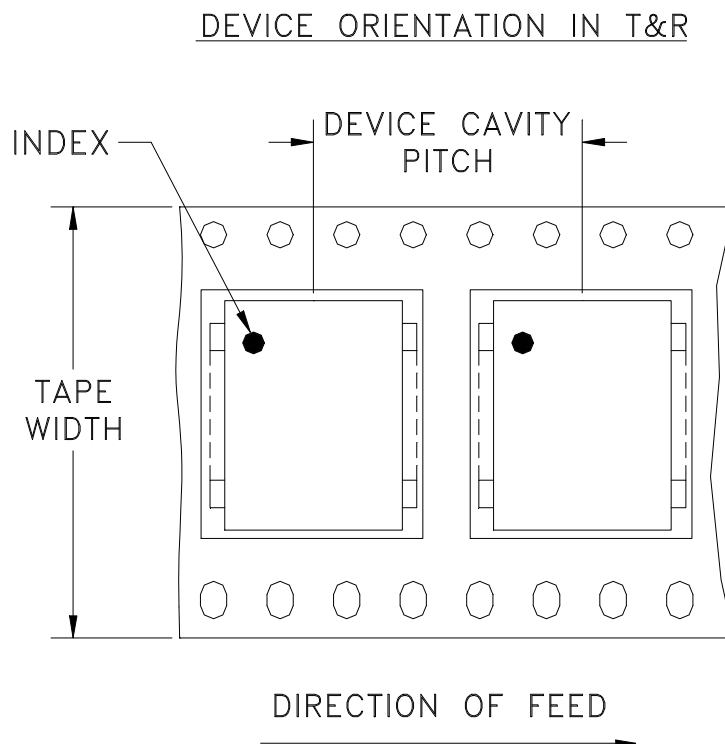

Tape Width, mm	Device Cavity Pitch, mm	Reel Size, inches	Devices per Reel
32	16	13	500

Mini-Circuits carrier tape materials provide protection from ESD (Electro-Static Discharge) during handling and transportation. Tapes are static dissipative and comply with industry standards EIA-481/EIA-541.

Go to: www.minicircuits.com/pages/pdfs/tape.pdf



Distribution Centers NORTH AMERICA 800-654-7949 • 417-335-5935 • Fax 417-335-5945 • EUROPE 44-1252-832600 • Fax 44-1252-837010

Mini-Circuits ISO 9001 & ISO 14001 Certified

INTERNET <http://www.minicircuits.com>

P.O. Box 350166, Brooklyn, New York 11235-0003 (718) 934-4500 Fax (718) 332-4661

THIRD ANGLE PROJECTION

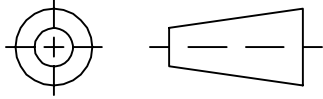

REVISIONS

REV	ECN No.	DESCRIPTION	DATE	DR	AUTH
OR	M101757	NEW RELEASE (FROM RAVON)	11/05	DK	HH
OR	R62293	NEW RELEASE (FROM RAVON)	11/05	DK	HH

**SUGGESTED MOUNTING CONFIGURATION
FOR HF1139 CASE STYLE, cr PIN CONNECTION, 50 OHM.**

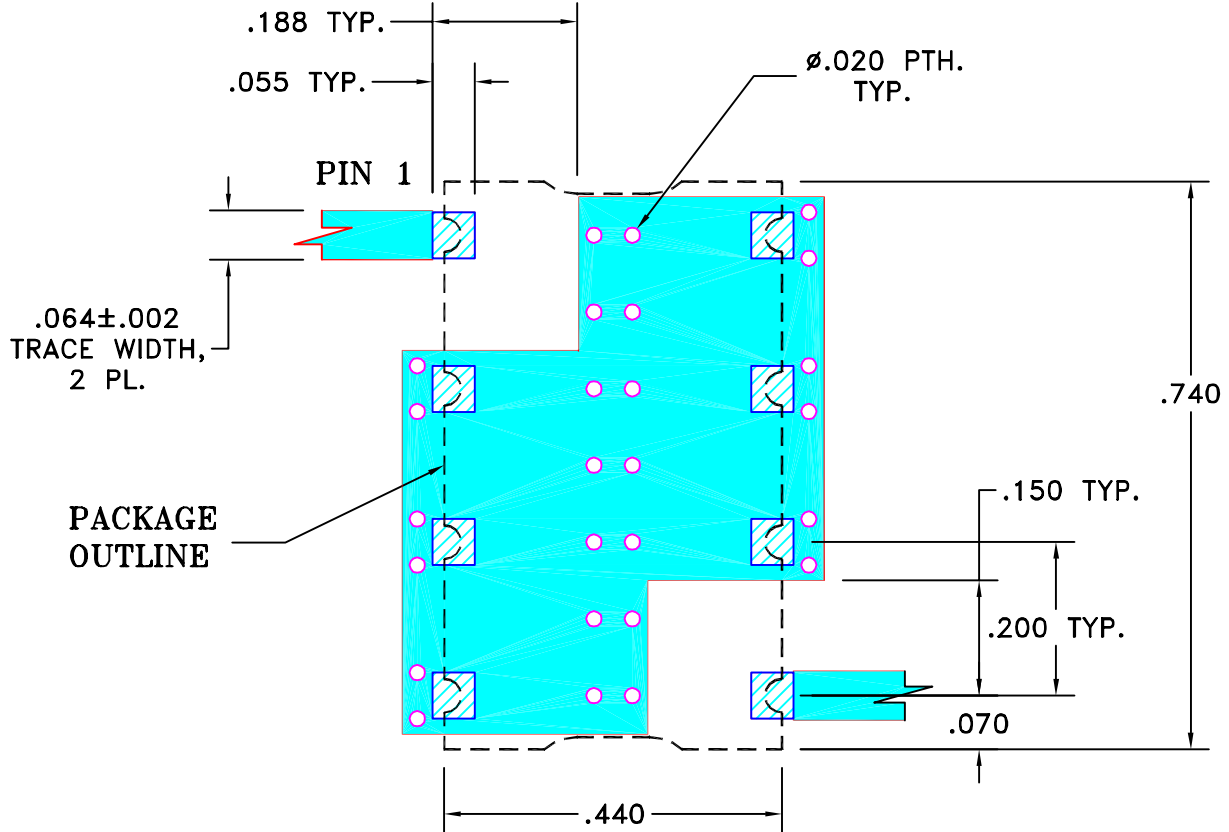

NOTE:

- TRACE WIDTH IS SHOWN FOR FR4 WITH DIELECTRIC THICKNESS: .025"±.002". COPPER: 1/2 OZ. EACH SIDE. FOR OTHER MATERIALS TRACE WIDTH MAY NEED TO BE MODIFIED.
- BOTTOM SIDE OF THE PCB IS CONTINUOUS GROUND PLANE.



DENOTES PCB COPPER LAYOUT WITH SMOBC (SOLDER MASK OVER BARE COPPER)

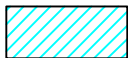

DENOTES COPPER LAND PATTERN FREE OF SOLDER MASK

UNLESS OTHERWISE SPECIFIED	INITIALS		DATE
DIMENSIONS ARE IN INCHES TOLERANCES ON: 2 PL DECIMALS ± 3 PL DECIMALS ± .005 ANGLES ± FRACTIONS ±	DRAWN	DK (RAVON)	29 NOV 05
	CHECKED	RZ (RAVON)	29 NOV 05
	APPROVED	HH (RAVON)	29 NOV 05



Mini-Circuits®

13 Neptune Avenue
Brooklyn NY 11235

PL, cr, HF1139, SCLF, TB-368

Mini-Circuits®
THIS DOCUMENT AND ITS CONTENTS ARE THE PROPERTY OF MINI-CIRCUITS. EXCEPT FOR USE EXPRESSLY GRANTED, IN WRITING, TO ITS VENDORS, VENDEE AND THE UNITED STATES GOVERNMENT, MINI-CIRCUITS RESERVES ALL PROPRIETARY DESIGN, USE, MANUFACTURING AND REPRODUCTION RIGHTS THERETO. THESE CONTENTS SHALL NOT BE USED, DUPLICATED OR DISCLOSED TO ANY OUTSIDE PARTY, IN WHOLE OR IN PART, WITHOUT WRITTEN PERMISSION OF MINI-CIRCUITS.

SIZE A	CODE IDENT 15542	DRAWING NO: 98-PL-230	REV: OR
FILE: 98PL230	SCALE: 4:1	SHEET: 1 OF 1	

Evaluation Board and Circuit

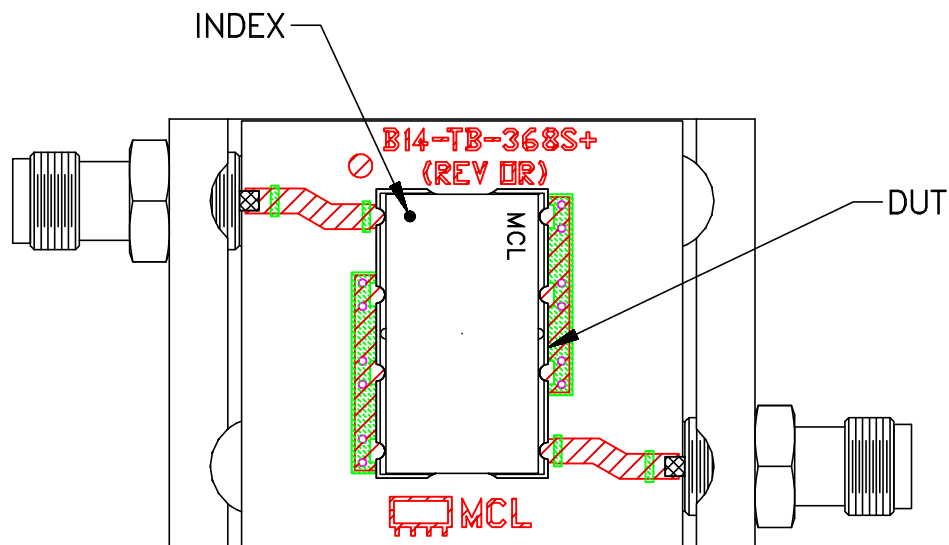

TB-368

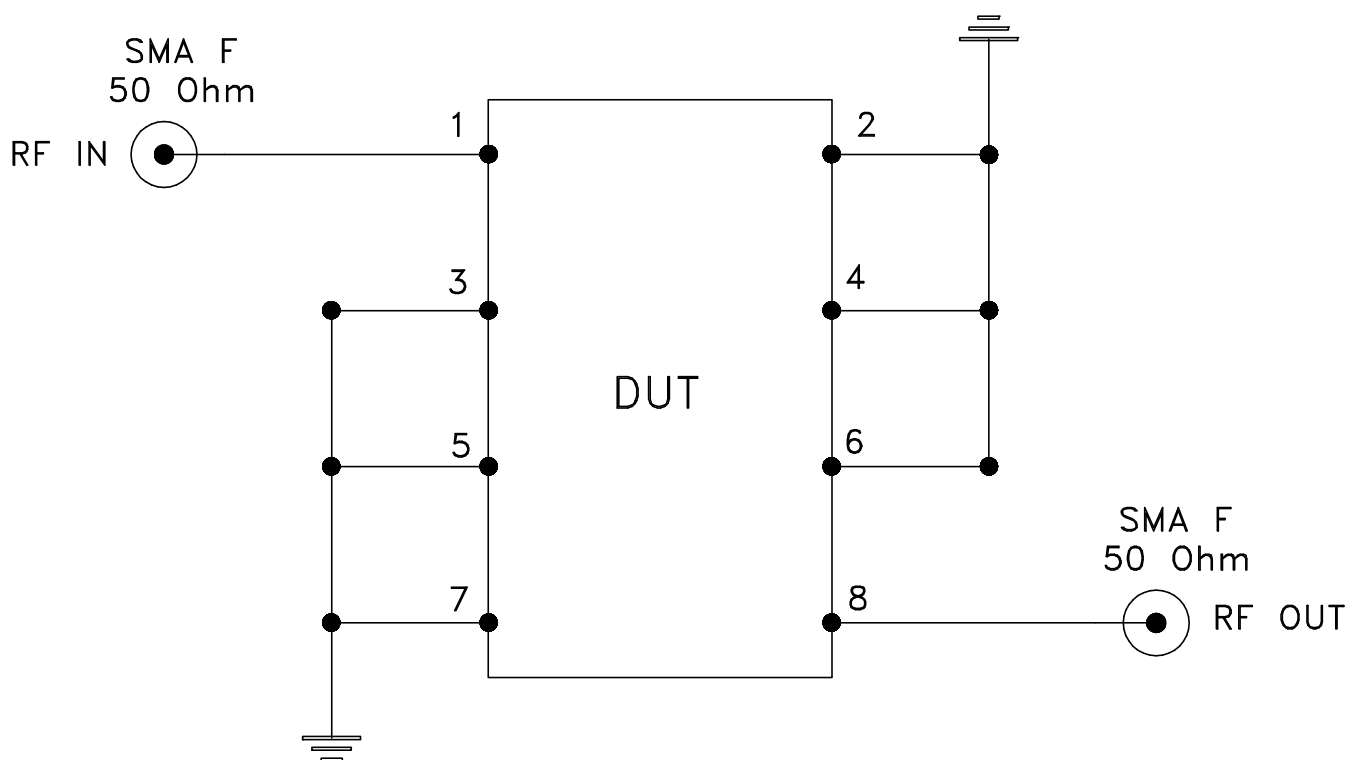

Schematic Diagram

Notes:

1. SMA Female connectors.
2. PCB Material: ROGERS R04350B or equivalent, Dielectric Constant=3.5, Thickness=.030 inch.

 **Mini-Circuits®**



All Mini-Circuits products are manufactured under exacting quality assurance and control standards, and are capable of meeting published specifications after being subjected to any or all of the following physical and environmental test.

Specification	Test/Inspection Condition	Reference/Spec
Operating Temperature	-40° to 85°C Ambient Environment	Individual Model Data Sheet
Storage Temperature	-55° to 100° C Ambient Environment	Individual Model Data Sheet
Humidity	90 to 95% RH, 240 hours, 50°C	MIL-STD-202, Method 103, Condition A, Except 50°C and end-point electrical test done within 12 hours
Thermal Shock	-55° to 100°C, 100 cycles	MIL-STD-202, Method 107, Condition A-3, except +100°C
Solder Reflow Heat	Sn-Pb Eutetic Process: 225°C peak Pb-Free Process 245° - 250°C peak	J-STD-020, Table 4-1, 4-2 and 5-2, Figure 5-1
Solderability	10X Magnification	J-STD-002, 95% Coverage
Vibration (High Frequency)	20g peak, 10-2000 Hz, 12 times in each of three perpendicular directions (total 36)	MIL-STD-202, Method 204, Condition D
Mechanical Shock	50g, 11 ms, 1/2-sine, 18 shocks: 3 each direction, each of 3 axes	MIL-STD-202, Method 213, Condition A
Marking Resistance to Solvents	Isopropyl alcohol + mineral spirits at 25°C; terpene defluxer at 25°C; distilled water + proylene glycol monomethyl ether + monoethanolamine at 63°C to 70°C	MIL-STD-202, Method 215