

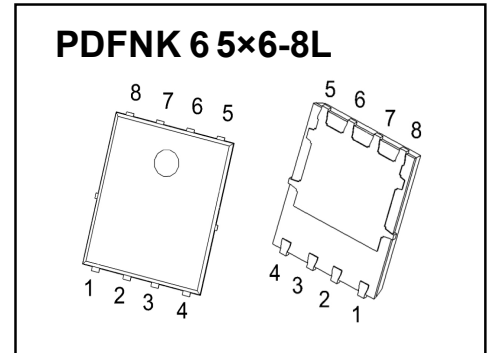

PDFNWB5×6-8L Plastic-Encapsulate MOSFETS

CJAC80SN10 N-Channel Power MOSFET

$V_{(BR)DSS}$	$R_{DS(on)TYP}$	I_D
100V	6.2mΩ@10V	80A
	8.8mΩ@4.5V	



DESCRIPTION

The CJAC80SN10 uses shielded gate trench technology and design to provide excellent $R_{DS(ON)}$ with low gate charge. It can be used in a wide variety of applications

FEATURE

- Excellent package for good heat dissipation
- Ultra low gate charge
- Low reverse transfer capacitance
- Fast switching capability
- Avalanche energy specified

APPLICATION

- Power switching application

MARKING

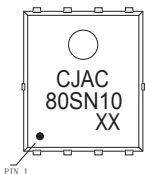

CJAC80SN10 = Part No.
 Solid dot = Pin1 indicator.
 XX = Code .

EQUIVALENT CIRCUIT

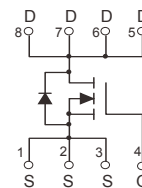

MAXIMUM RATINGS ($T_a=25^{\circ}C$ unless otherwise noted)

Parameter	Symbol	Limit	Unit
Drain-Source Voltage	V_{DS}	100	V
Gate-Source Voltage	V_{GS}	±20	V
Continuous Drain Current	I_D ①	80	A
Pulsed Drain Current	I_{DM} ②	320	A
Single Pulsed Avalanche Energy	E_{AS} ③	280	mJ
Power Dissipation	P_D ①	100	W
Thermal Resistance from Junction to Ambient	$R_{\theta JA}$ ⑥	62.5	°CW
Thermal Resistance from Junction to Case	$R_{\theta JC}$ ①	1.25	°CW
Operating Junction and Storage Temperature Range	T_J, T_{stg}	-55~+150	°C

MOSFET ELECTRICAL CHARACTERISTICS

$T_a=25^\circ\text{C}$ unless otherwise specified

Parameter	Symbol	Test Condition	Min	Typ	Max	Unit
Off characteristics						
Drain-source breakdown voltage	$V_{(BR)DSS}$	$V_{GS} = 0V, I_D = 250\mu A$	100			V
Zero gate voltage drain current	I_{DSS}	$V_{DS} = 80V, V_{GS} = 0V$	$T_J = 25^\circ\text{C}$		1.0	μA
			$T_J = 125^\circ\text{C}$		100	
Gate-body leakage current	I_{GSS}	$V_{DS} = 0V, V_{GS} = \pm 20V$			± 100	nA
On characteristics ^④						
Gate-threshold voltage	$V_{GS(th)}$	$V_{DS} = V_{GS}, I_D = 250\mu A$	1.3	1.9	2.5	V
Static drain-source on-state resistance	$R_{DS(on)}$	$V_{GS} = 10V, I_D = 20A$		6.2	8.5	m Ω
		$V_{GS} = 4.5V, I_D = 15A$		8.8	10.5	m Ω
Dynamic characteristics ^{④ ⑤}						
Input capacitance	C_{iss}	$V_{DS} = 50V, V_{GS} = 0V, f = 500KHz$		2100	3150	μF
Output capacitance	C_{oss}			420	650	
Reverse transfer capacitance	C_{rss}			4.5	8.0	
Gate resistance	R_g	$f = 1MHz$		3.0		Ω
Switching characteristics ^{④ ⑤}						
Total gate charge	Q_g	$V_{GS} = 10V, V_{DS} = 50V, I_D = 20A$		50	100	nC
Gate-source charge	Q_{gs}			5.2	10	
Gate-drain charge	Q_{gd}			9.2	18	
Turn-on delay time	$t_{d(on)}$	$V_{DD} = 50V, I_D = 20A, V_{GS} = 10V, R_G = 3\Omega$		$\dot{I} \dot{E}$		ns
Turn-on rise time	t_r			$I \dot{E}$		
Turn-off delay time	$t_{d(off)}$			$\dot{G} \dot{G}$		
Turn-off fall time	t_f			$\dot{I} \dot{E}$		
Drain-Source Diode Characteristics						
Drain-source diode forward voltage	V_{SD} ^④	$V_{GS} = 0V, I_S = 10A$			1.2	V
Continuous drain-source diode forward current	I_S ^①				80	A
Pulsed drain-source diode forward current	I_{SM} ^②				320	A

Notes:

1. $T_c = 25^\circ\text{C}$ Limited only by maximum temperature allowed.

2. $P_w \leq 10\mu s$, Duty cycle $\leq 1\%$.

3. EAS condition: $V_{DD} = 50V, V_{GS} = 10V, L = 0.5mH, R_g = 25\Omega$ Starting $T_J = 25^\circ\text{C}$.

4. Pulse Test : Pulse Width $\leq 300\mu s$, duty cycle $\leq 2\%$.

5. Guaranteed by design, not subject to production.

6. The value of $R_{\theta JA}$ is measured with the device mounted on 1 in 2 FR-4 board with 2oz. Copper, in a still air environment with $T_a = 25^\circ\text{C}$.

Typical Characteristics

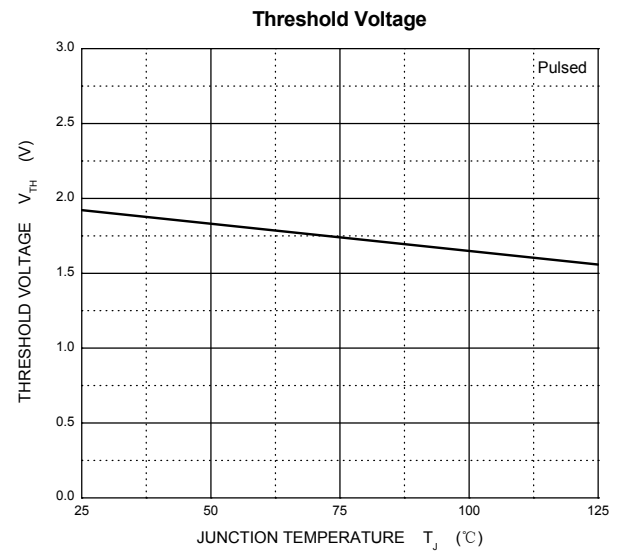
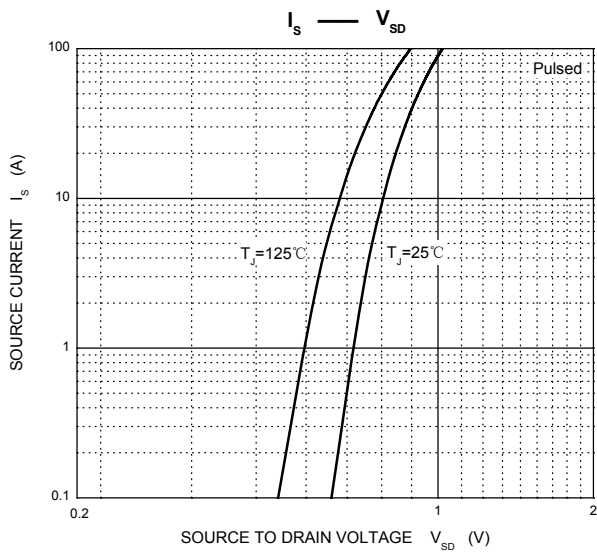
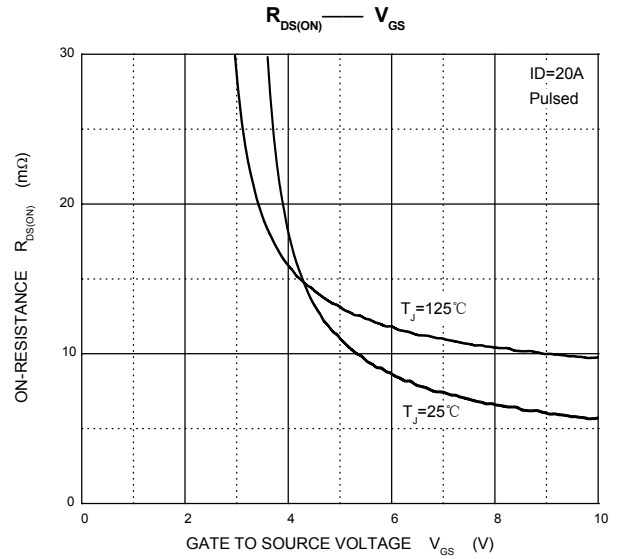
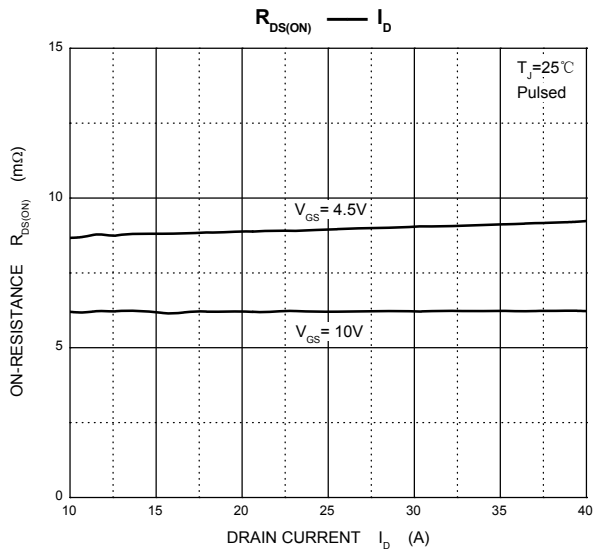
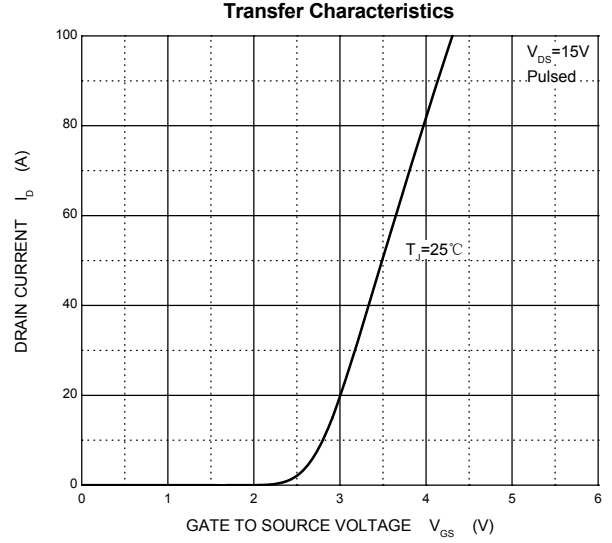
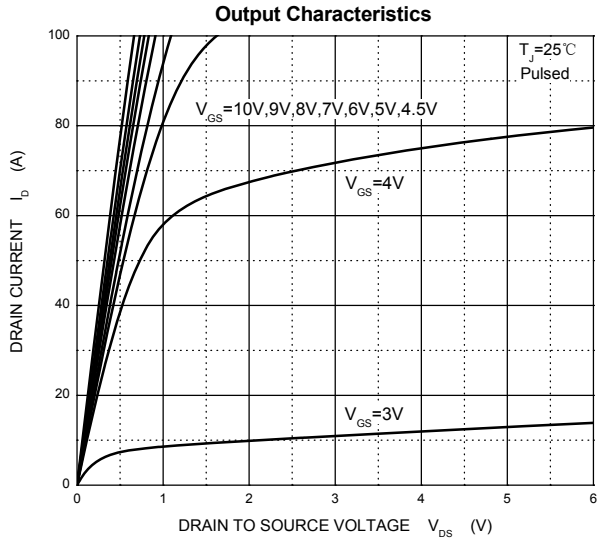

Typical Characteristics

Capacitances

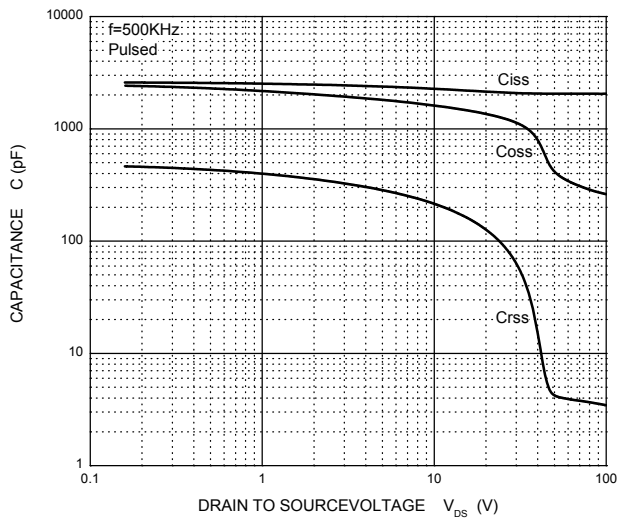

Gate Charge

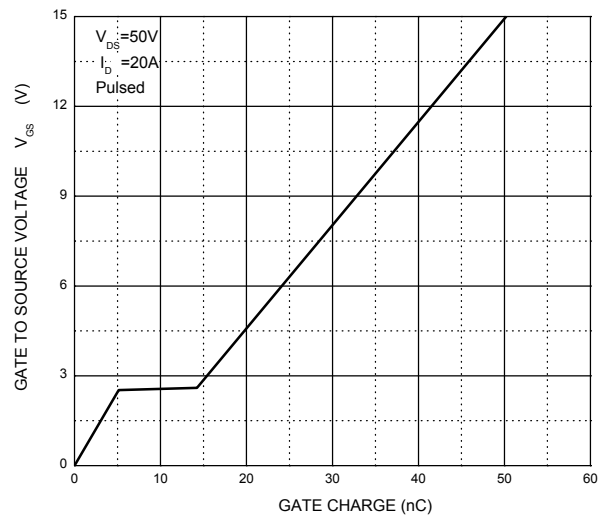

NORMALIZED MAXIMUM TRANSIENT THERMAL IMPEDANCE

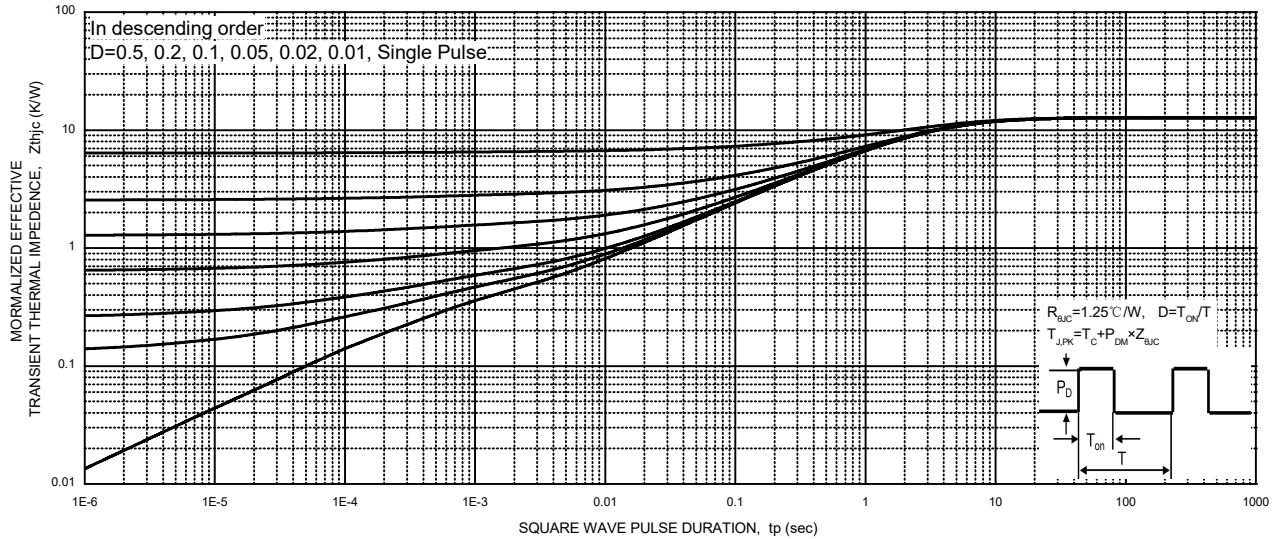

MAXIMUM FORWARD BIASED SAFE OPERATING AREA

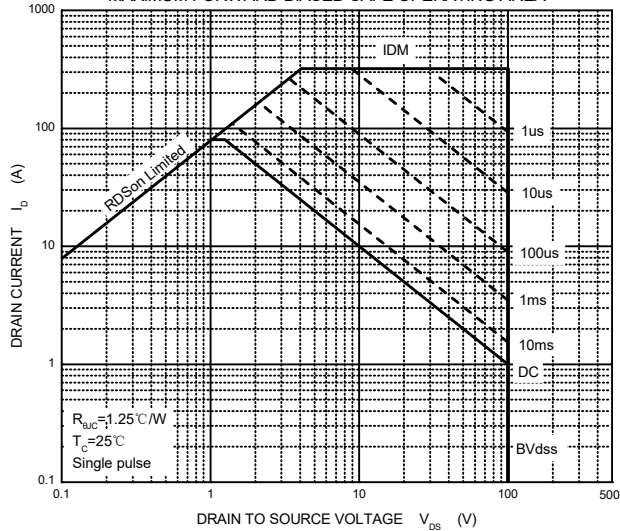

PDFNWB5x6-8L Package Outline Dimensions

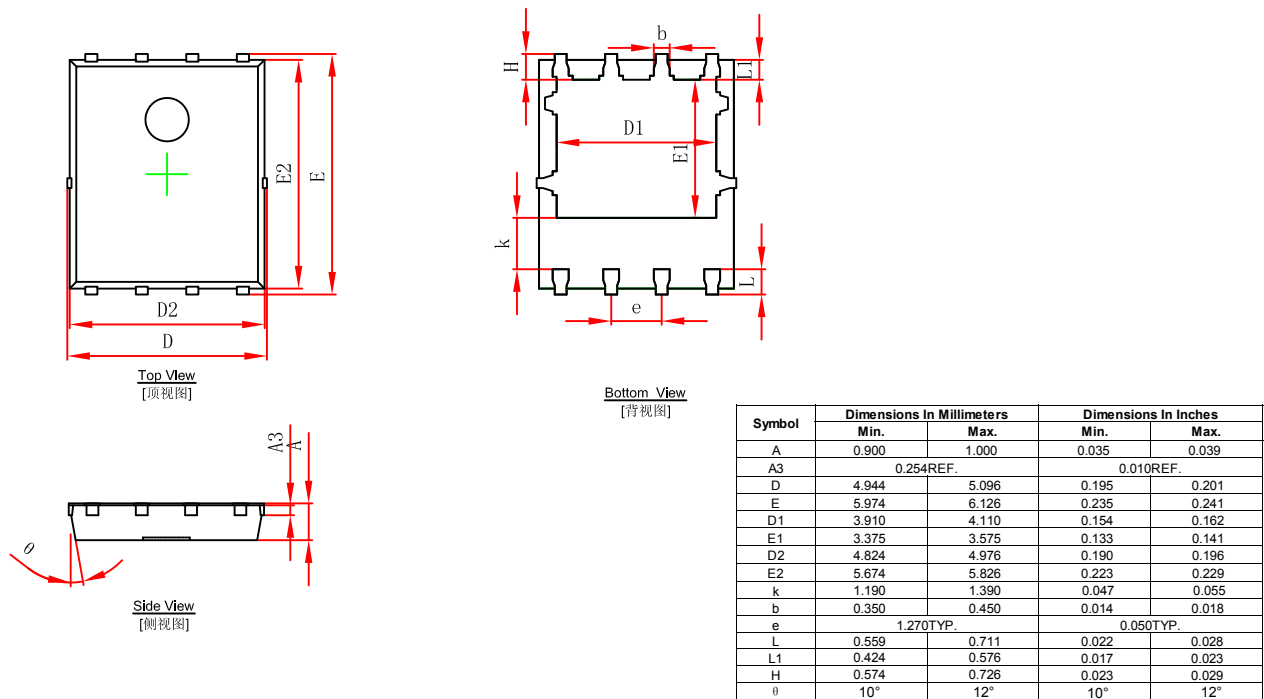

PDFNWB5x6-8L Suggested Pad Layout

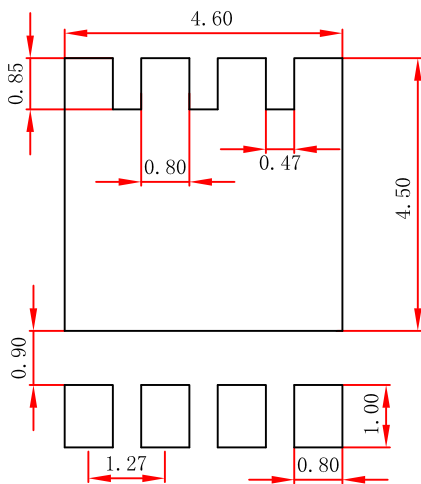

Note:

1. Controlling dimension: in millimeters.
2. General tolerance: ± 0.05 mm.
3. The pad layout is for reference purposes only.

NOTICE

JCET reserve the right to make modifications, enhancements, improvements, corrections or other changes without further notice to any product herein. JCET does not assume any liability arising out of the application or use of any product described herein.

PDFNWB5×6 Tape and Reel

PDFNWB5×6-8L Embossed Carrier Tape

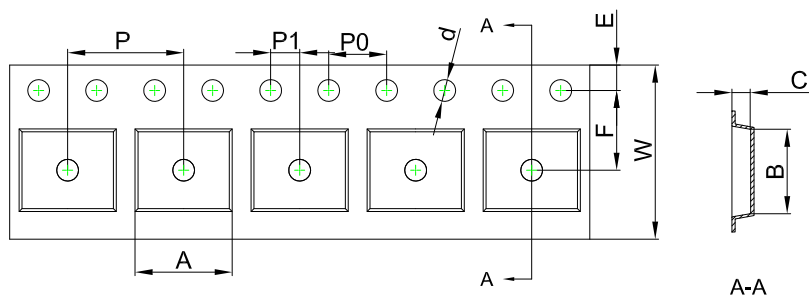

Packaging Description:
PDFNWB5×6-8L parts are shipped in tape. The carrier tape is made from a dissipative (carbon filled) polycarbonate resin. The cover tape is a multilayer film (Heat Activated Adhesive in nature) primarily composed of polyester film, adhesive layer, sealant, and anti-static sprayed agent. These reeled parts in standard option are shipped with 5,000 units per 13" or 33.0 cm diameter reel. The reels are clear in color and is made of polystyrene plastic (anti-static coated).

Dimensions are in millimeter										
Pkg type	A	B	C	d	E	F	P0	P	P1	W
PDFNWB5×6-8L	6.30	5.30	1.10	Ø1.50	1.75	5.50	4.00	8.00	2.00	12.00

PDFNWB5×6-8L Tape Leader and Trailer

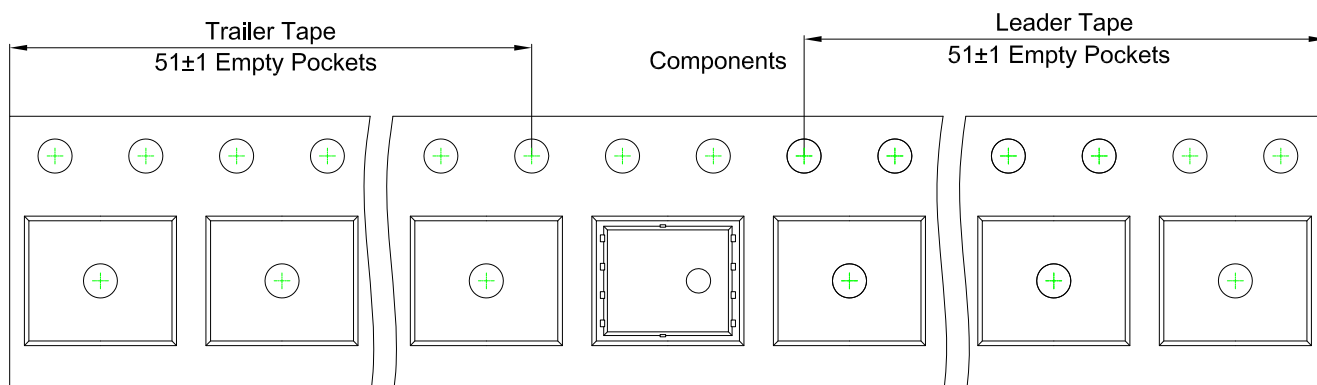

PDFNWB5×6-8L Reel

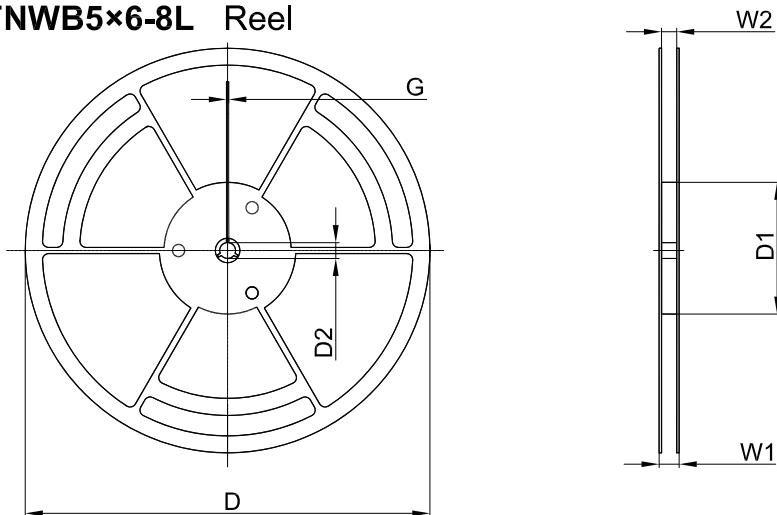

Dimensions are in millimeter						
Reel Option	D	D1	D2	G	W1	W2
13"Dia	Ø330.00	100.00	13.00	1.90	17.60	12.40

REEL	Reel Size	Box	Box Size(mm)	Carton	Carton Size(mm)
5,000 pcs	13 inch	5,000 pcs	340×336×29	50,000 pcs	353×346×365