

RoHs

VER	MARK	PR. BY	ECR/ECN	DESCRIPTION	DATE
A				NEW RELEASE	05/19' 21

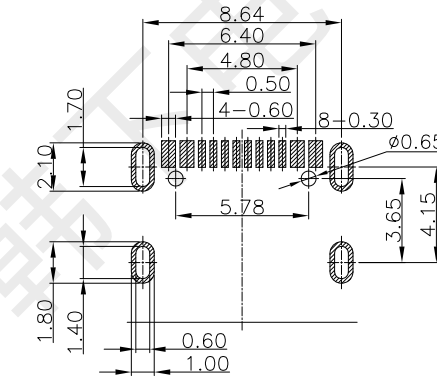
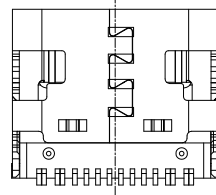
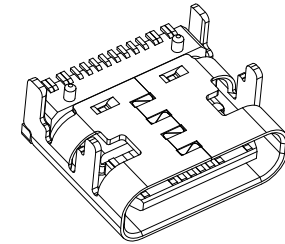
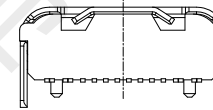
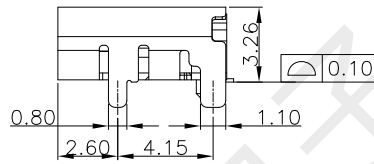
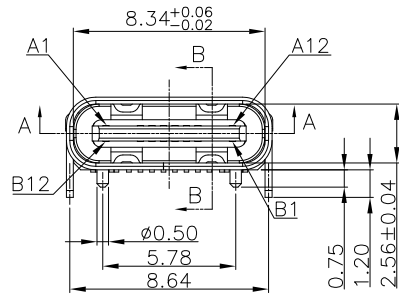
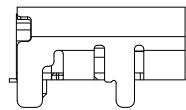
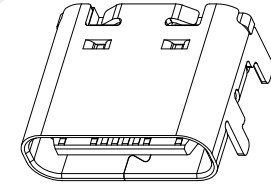
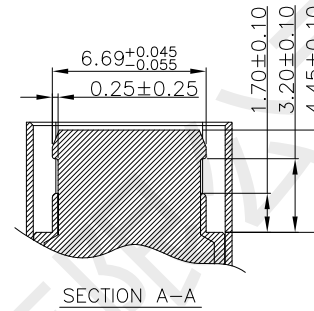
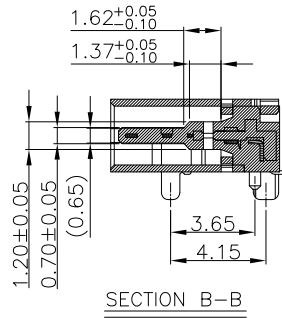
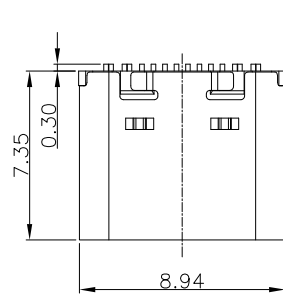

RECOMMENDED P.C.B. LAYOUT
TOLERANCE UNSPECIFIED ±0.05mm
Recommended PCB Thickness: 1.0mm~1.2mm

USB TYPE-C PIN ASSIGNMENTS

PIN NUMBER	SIGNAL NAME	PIN NUMBER	SIGNAL NAME
A1	GND	B12	GND
A4	VBUS	B9	VBUS
A5	CC1	B8	SBU2
A6	Dp1	B7	Dn2
A7	Dn1	B6	Dp2
A8	SBU1	B5	CC2
A9	VBUS	B4	VBUS
A12	GND	B1	GND

规格说明 Specifications:

1. 电气特性 Electrical:

- 额定电压 (Rated voltage): 20V DC
- 额定电流 (Rated current): 3A VBUS引脚; 1.25A用于GND引脚, 其他引脚为0.25A.
- 接触电阻 (Contact resistance): 40mΩ Max 测试条件: 20mv, 100mA下测量.
- 绝缘电阻 (Insulation resistance): 100MΩ Min
- 耐电压 (Withstand Voltage): 100V AC

2. 机械性能 Mechanical:

- 插入力 (Mate force): 0.5-2.0Kg
- 拔出力 (Unmate force): 0.6-2.0Kg
- 插拔次数 (Durability): 10000 Cycles.

3. 材料 Material:

- 胶芯 (Housing): LCP UL94 V-0
- 端子 (Contact): C2680, T=0.2mm; 镍底, 镀金
- 外壳 (Shell): 不锈钢201-H 表面镀锌

4. 温度范围 (Temperature Range): -30°C to +80°C.

CUSTOMER		GENERAL TOLERANCES UNLESS SPECIFIED		APPROVED BY: 罗小春	TITLE: TYPE-C
SIZE A4	UNITS MM[INCH]	X±0.50 .X±0.35	X*±5.0° .X*±3.0°	CHECKED BY: 张伟	PART NO.: HX TYPE-C 16PIN 3MD 385
SCALE 1:1	REV. A	.XX±0.25 .XXX±0.15	.XX*±2.5° .XXX*±2.0°	DESIGN BY: 黄彬	DWG NO.:
				SHEET 1/2	

