

## 352-4621 Spacer/Stand-off, insulated, threaded

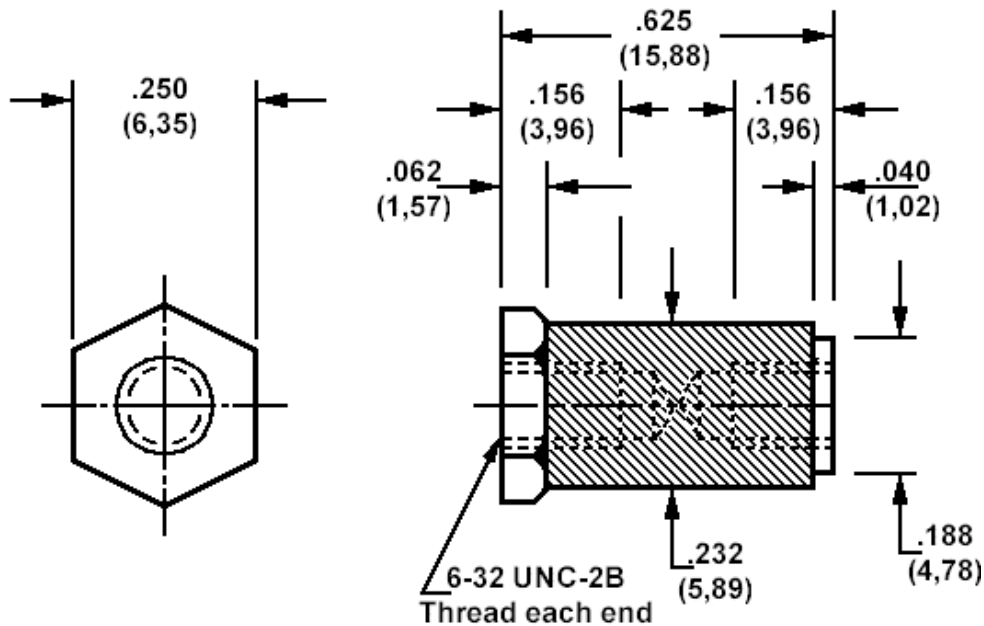

How to order code  
352-4621-01-07-16  
 Basic Part No

MATERIALS		
Component	Material	Finish
Studs	Brass	Cadmium (plus Chromate)
Insulator	Diallyl Phthalate	Blue

Other colour insulators available on request

ADDITIONAL SPECIFICATIONS	
Dielectric Withstanding Voltage (VRMS)	6000
Capacitance (pF)	.6