

UCC24650 200-V Wake-Up Monitor for Fast Transient PSR

1 Features

- Enables Excellent Load Transient Performance and Zero Standby Power
- Enables Smallest Output Capacitor for Tight ΔV_{OUT}
- No External Components Required
- <50 μA Device Current Consumption (Typical)
- 5-V to 28-V Output Monitoring Capability
- 3% Voltage Droop Detection (Patent Pending)
- 200-V Wake-Up Switch
- Enables and Disables SR Controller, Relay Control, or Other Secondary Circuits
- SOT-23 5-Pin Package

2 Applications

- <5-mW Zero-Power Standby Applications
- Adapters and Chargers for Consumer Electronics
 - Smart Phones, Tablets, Set-Top Box
- TV and Monitor Power Supplies
- Home Appliance SMPS
 - Refrigerator, Washing Machine, Air Conditioners
- Industrial Power Supplies for Lighting and Home Automation

3 Description

The UCC24650 is an easy-to-use secondary-side voltage monitor that periodically measures its own VDD voltage. A relative droop of 3% from the previous reading triggers a *wake-up* alert signal to a receiving primary-side regulation (PSR) controller. Its low-power consumption helps achieve <5-mW Zero-Power standby loss in many applications.

An internal 200-V MOSFET switch is applied across a ground-referenced rectifier to provide a current-limited pulse to the flyback transformer secondary winding, which couples the signal to the primary-side controller. This signal is repeated at 33 kHz until controller-driven switching activity is detected.

Relative-droop detection allows scaling to any voltage between 5 and 28 V. The *wake-up* alert function allows very-low standby frequency to minimize switching loss and reduction of output capacitance needed to respond to a heavy load step. This monitor is used with a controller capable of detecting the *wake-up* signal, such as the UCC28730 PSR flyback controller.

The UCC24650 also provides an enable and disable signal which can be used to control a secondary-side circuit during no-load conditions to reduce standby power loss. Such a circuit may be a synchronous rectifier controller or a relay driver, for example.

Device Information⁽¹⁾

PART NUMBER	PACKAGE	BODY SIZE (NOM)
UCC24650	SOT-23 (5)	2.92 mm x 1.30 mm

(1) For all available packages, see the orderable addendum at the end of the data sheet.

Simplified Application Schematic

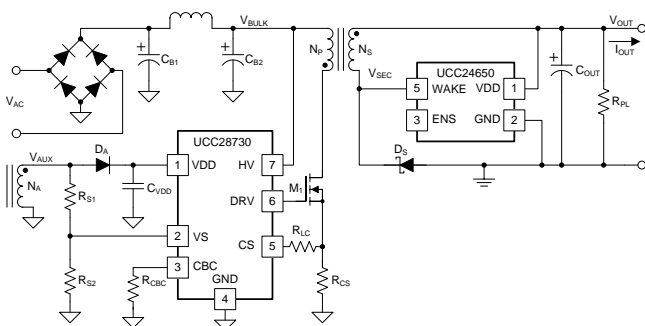

Rapid Full-Load Step Response

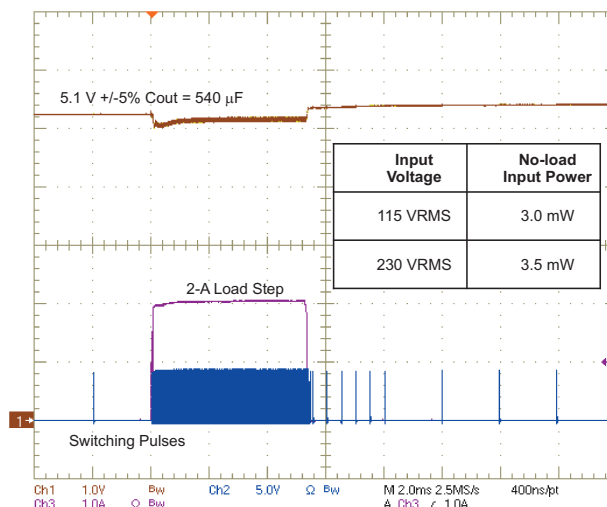

Table of Contents

1 Features	1	7.2 Functional Block Diagram	9
2 Applications	1	7.3 Feature Description.....	10
3 Description	1	7.4 Device Functional Modes.....	16
4 Revision History	2	8 Application and Implementation	17
5 Pin Configuration and Functions	3	8.1 Application Information.....	17
6 Specifications	4	8.2 Typical Application	17
6.1 Absolute Maximum Ratings	4	9 Power Supply Recommendations	19
6.2 ESD Ratings.....	4	10 Layout	20
6.3 Recommended Operating Conditions	4	10.1 Layout Guidelines	20
6.4 Thermal Information	4	10.2 Layout Example	20
6.5 Electrical Characteristics.....	5	11 Device and Documentation Support	21
6.6 Timing Requirements	6	11.1 Documentation Support	21
6.7 Switching Characteristics	6	11.2 Trademarks	21
6.8 Typical Characteristics	7	11.3 Electrostatic Discharge Caution.....	21
7 Detailed Description	9	11.4 Glossary	21
7.1 Overview	9	12 Mechanical, Packaging, and Orderable Information	21

4 Revision History

DATE	REVISION	NOTES
February 2015	*	Initial release.

5 Pin Configuration and Functions

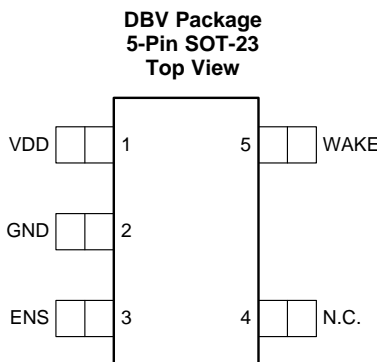

A. (N.C. = No connection internally)

Pin Functions

PIN		I/O ⁽¹⁾	DESCRIPTION
NAME	NO.		
VDD	1	P	VDD is the bias supply input pin to the controller. This pin is continuously monitored to detect when the VDD voltage droops by approximately –3% of the previously sampled level. The VDD level is sampled and stored at the end of each power cycle generated by the PSR. The device is disabled when the VDD voltage is below the UVLO threshold.
GND	2	G	The ground pin is both the reference pin for the controller and the low-side return for the WAKE output. Take special care to return all AC decoupling capacitors as close as possible to this pin and avoid any common trace length with analog signal return paths.
ENS	3	O	Enable secondary circuit is an open-drain MOSFET output that enables a compatible synchronous rectifier (SR) controller or other secondary-side circuitry. ENS is open during normal operation and becomes low-impedance to GND when each switching period remains greater than t_{DISS} (177 μ s typical) for 63 consecutive cycles. ENS becomes high-impedance again when the switching period operates at less than t_{ENS} (57 μ s typical) for 32 cumulative cycles. If the ENS function is not used, this terminal should be connected to GND.
N/C	4	—	The no-connection pin has no internal electrical connection.
WAKE	5	I/O	WAKE is a multi-function pin which connects to the transformer secondary winding, directly across the ground-referenced diode or rectifier. As an input, it monitors voltage pulses due to primary-side controller activity and triggers sampling of the VDD voltage at the end of each power cycle. When the WAKE voltage falls below 55 mV for >500 ns, the device becomes armed to deliver a power cycle detect (PCD) pulse internally. When the WAKE voltage subsequently rises above 55 mV, a PCD pulse is delivered to reset the oscillator, clock the PCD counter, and trigger a new sample of the VDD voltage. If the VDD voltage droops to 97% of the last sampled value, WAKE is driven as an output. As an output, it injects current into the transformer winding for 1 μ s at a 33-kHz rate until a power cycle is detected. The maximum magnitude that this current may achieve is limited internally.

(1) P = Power, G = Ground, I = Input, O = Output, I/O = Input/Output

6 Specifications

6.1 Absolute Maximum Ratings

over operating free-air temperature range (unless otherwise noted)⁽¹⁾

		MIN	MAX	UNIT
Input voltage	VCC	-0.5	30	V
	WAKE	⁽²⁾	230	
	ENS	-0.5	7	
Source current	WAKE		10	mA
	ENS		1	
Sink current	WAKE		Self-limiting	mA
	ENS		0.5	
T _J	Operating junction temperature	-55	150	°C
T _{lead}	Lead temperature 0.6 mm from case for 10 s		260	
T _{stg}	Storage temperature	-65	150	

- (1) Stresses beyond those listed under *Absolute Maximum Ratings* may cause permanent damage to the device. These are stress ratings only, which do not imply functional operation of the device at these or any other conditions beyond those indicated under *Recommended Operating Conditions*. Exposure to absolute-maximum-rated conditions for extended periods may affect device reliability.
- (2) The WAKE pin is normally brought below GND by a system-level rectifier. A negative voltage level is not of concern provided that the absolute maximum source current limit is observed.

6.2 ESD Ratings

			VALUE	UNIT	
V _(ESD)	Electrostatic discharge	Human body model (HBM), per ANSI/ESDA/JEDEC JS-001 ⁽¹⁾	All pins except pin 5	±2000	V
			Pin 5	±1500	
		Charged-device model (CDM), per JEDEC specification JESD22-C101 ⁽²⁾	All pins	±1000	

- (1) JEDEC document JEP155 states that 500-V HBM allows safe manufacturing with a standard ESD control process.
- (2) JEDEC document JEP157 states that 250-V CDM allows safe manufacturing with a standard ESD control process.

6.3 Recommended Operating Conditions

over operating free-air temperature range (unless otherwise noted)

		MIN	NOM	MAX	UNIT
V _{VDD}	Bias-supply operating voltage	4.5		28	V
V _{WAKE}	WAKE pin voltage			200	V
V _{ENS}	ENS pin voltage ⁽¹⁾	0		6	V
t _{PCD}	Power cycle detect interval			40	ms
T _J	Operating junction temperature range	-40		125	°C

- (1) The UCC24650 enters a manufacturing test mode when ENS is driven below 0 V and normal operation is impaired during this condition. If the ENS function is not used, connect ENS to GND to avoid triggering the test mode by noise on an open pin.

6.4 Thermal Information

THERMAL METRIC ⁽¹⁾		UCC24650	UNIT
		DBV	
		5 PINS	
R _{θJA}	Junction-to-ambient thermal resistance	200.2	°C/W
R _{θJC(top)}	Junction-to-case (top) thermal resistance	125.5	
R _{θJB}	Junction-to-board thermal resistance	35.8	
ψ _{JT}	Junction-to-top characterization parameter	18.4	
ψ _{JB}	Junction-to-board characterization parameter	35.0	

- (1) For more information about traditional and new thermal metrics, see the *IC Package Thermal Metrics* application report, [SPRA953](#).

6.5 Electrical Characteristics

over operating free-air temperature range, $V_{VDD} = 5\text{ V}$, $V_{WAKE} = 5\text{ V}$, $-40^{\circ}\text{C} \leq T_A \leq 125^{\circ}\text{C}$, $T_J = T_A$, (unless otherwise noted)

PARAMETER	TEST CONDITIONS	MIN	TYP	MAX	UNIT		
SUPPLY INPUT							
I_{VDD28}	Supply current	$V_{VDD} = 28\text{ V}$, $V_{WAKE} = 28\text{ V}$		43	63	83	μA
I_{VDD5}	Supply current	$V_{VDD} = 5\text{ V}$, $V_{WAKE} = 5\text{ V}$		30	41	52	μA
$V_{UVLO(on)}$	UVLO turn-on voltage at VDD	V_{VDD} rising threshold		3.6	4.0	4.4	V
$V_{UVLO(hyst)}$	UVLO hysteresis	$V_{UVLO(on)} - V_{VDD}$ falling threshold		170	250	330	mV
WAKE INPUT							
V_{PCD}	PCD voltage threshold	V_{WAKE} high to low		10	55	100	mV
I_{WAKE}	Input bias current, out of pin	$V_{WAKE} = 0\text{ V}$			0	0.1	μA
$I_{WAKE(Ikg)cool}^{(1)}$	Input leakage current, into pin, cool	$V_{WAKE} = 200\text{ V}$, $-40^{\circ}\text{C} \leq T_J \leq 85^{\circ}\text{C}$			0	0.2	μA
$I_{WAKE(Ikg)hot}^{(1)}$	Input leakage current, into pin, hot	$V_{WAKE} = 200\text{ V}$, $85^{\circ}\text{C} \leq T_J \leq 125^{\circ}\text{C}$			0	3	μA
WAKE-UP FUNCTION							
$\Delta V_{VDD5(cool)}^{(1)(2)}$	Droop threshold, over cool temperature range	Drop in V_{VDD} following a power-cycle detect by 40 ms, V_{VDD} falling from 5 V, $dv/dt = -250\text{ V/s}$, $-40^{\circ}\text{C} \leq T_J \leq 85^{\circ}\text{C}$		-2.30%	-2.77%	-3.20%	
$\Delta V_{VDD5(hot)}^{(1)(2)}$	Wake-up droop threshold, over hot temperature range	Drop in V_{VDD} following a power-cycle detect by 40 ms, V_{VDD} falling from 5 V, $dv/dt = -250\text{ V/s}$, $85^{\circ}\text{C} \leq T_J \leq 125^{\circ}\text{C}$		-1.50%	-2.74%	-4.0%	
$\Delta V_{VDD28}^{(1)(2)}$	Wake-up droop threshold, over full temperature range	Drop in V_{VDD} following a power-cycle detect by 40 ms, V_{VDD} falling from 28 V, $dv/dt = -250\text{ V/s}$		-2.3%	-2.7%	-3.2%	
$I_{WAKE(on)25}$	Wake-up drive current, room temperature	$V_{WAKE} = 4\text{ V}$, $T_J = 25^{\circ}\text{C}$		20	27		mA
$I_{WAKELMT}$	Wake-up current limit	$V_{VDD} = 28\text{ V}$, $V_{WAKE} = 28\text{ V}$		35	48	60	mA
ENABLE SECONDARY CIRCUIT FUNCTION							
$I_{ENS(Ikg)}$	ENS switch leakage current	$V_{ENS} = 5\text{ V}$, off-state			0	0.1	μA
$R_{ENS(RDS(on))}$	ENS switch on-resistance	$I_{ENS} = 100\text{ }\mu\text{A}$, on-state		1.3	2.7	5.0	k Ω

(1) Device parameter characterized during development. Not production tested, except at 25°C.

(2) For droop threshold at higher dv/dt , see [Typical Characteristics](#).

6.6 Timing Requirements

over operating free-air temperature range, $V_{VDD} = 5\text{ V}$, $V_{WAKE} = 5\text{ V}$, $-40^{\circ}\text{C} \leq T_A \leq 125^{\circ}\text{C}$, $T_J = T_A$, (unless otherwise noted)

		MIN	NOM	MAX	UNIT
$t_{PCD(min)}$	PCD minimum time for $V_{WAKE} < V_{PCD}$	350	500	650	ns
$t_{SW(max)}$	PCD maximum period for ΔV_{VDD}			40	ms

6.7 Switching Characteristics

over operating free-air temperature range, $V_{VDD} = 5\text{ V}$, $V_{WAKE} = 5\text{ V}$, $-40^{\circ}\text{C} \leq T_A \leq 125^{\circ}\text{C}$, $T_J = T_A$, (unless otherwise noted)

PARAMETER	TEST CONDITIONS	MIN	TYP	MAX	UNIT	
WAKE-UP FUNCTION						
t_{WAKE}	Wake-up pulse width	$\Delta V_{VDD} \geq -5\%$ after PCD	0.7	1	1.3	μs
$t_{WAKE(rep)}$	Wake-up repeat period	$\Delta V_{VDD} \geq -5\%$ after PCD	21	30	39	μs
ENABLE SECONDARY CIRCUIT FUNCTION						
$t_{ENS}^{(1)}$	Qualifying t_{SW} to enable secondary circuit	WAKE input toggling	40	57	74	μs
N_{ENS}	Cumulative cycles to enable secondary circuit	$t_{SW} < t_{ENS}$	32			cycles
$t_{DISS}^{(1)}$	Qualifying t_{SW} to disable secondary circuit	WAKE input toggling	124	177	230	μs
N_{DISS}	Consecutive cycles to disable secondary circuit	$t_{SW} > t_{DISS}$	63			cycles

(1) By design, the ratio of t_{ENS} to t_{DISS} remains within $\pm 10\%$ of typical, over all conditions. Not production tested.

6.8 Typical Characteristics

$V_{VDD} = 5\text{ V}$, $V_{WAKE} = 5\text{ V}$, $T_A = 25^\circ\text{C}$, $T_J = T_A$, (unless otherwise noted)

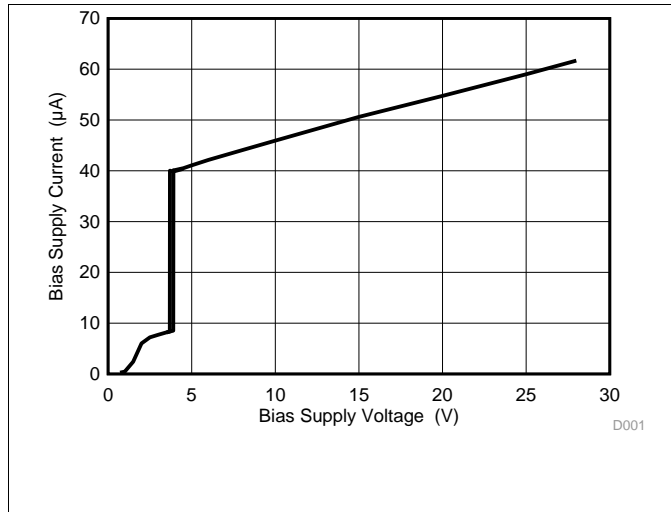

Figure 1. Bias Supply Current vs Bias Supply Voltage

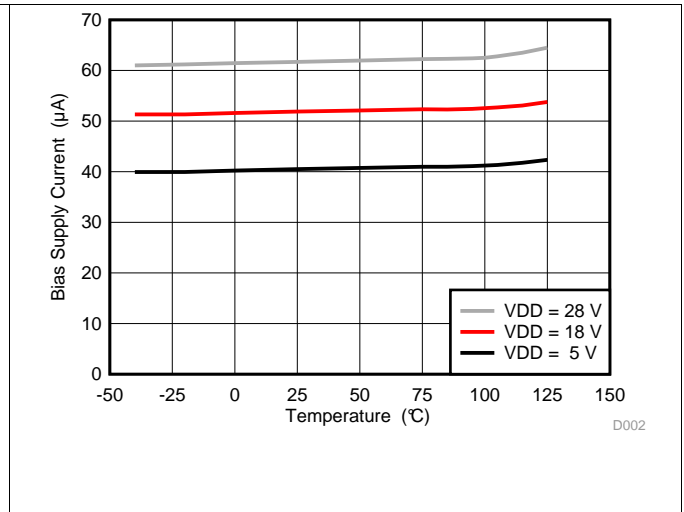

Figure 2. Bias Supply Current vs Temperature

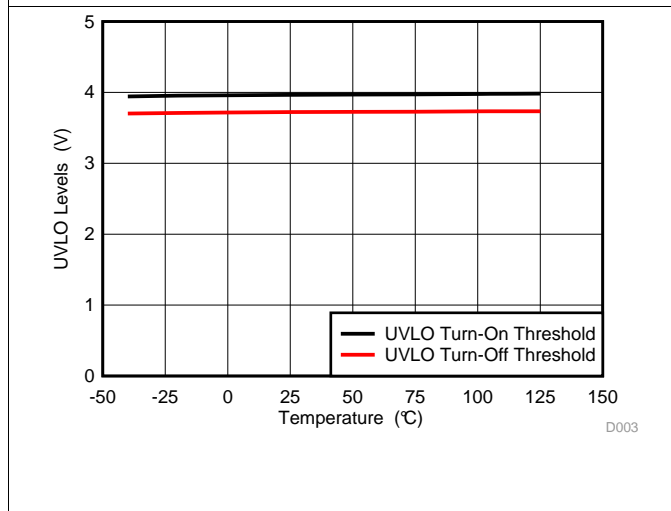

Figure 3. UVLO Thresholds vs Temperature

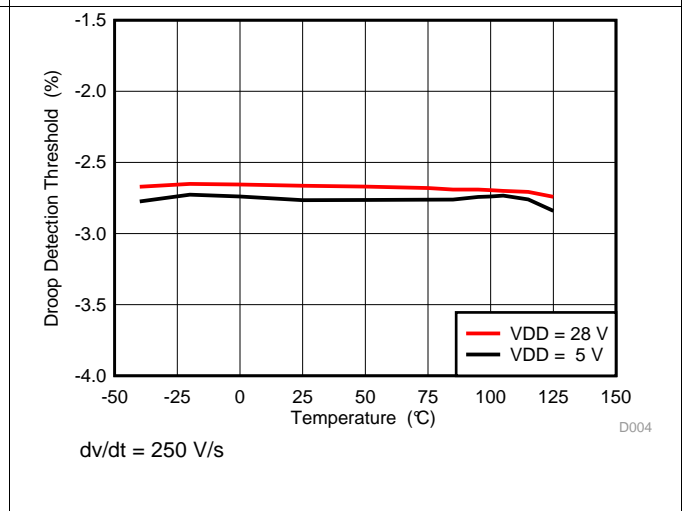

Figure 4. Droop Detection Threshold vs Temperature

dv/dt = 250 V/s

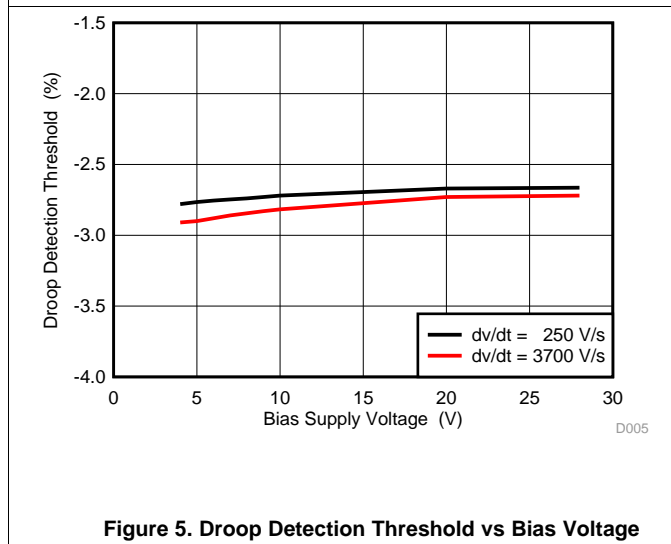

Figure 5. Droop Detection Threshold vs Bias Voltage

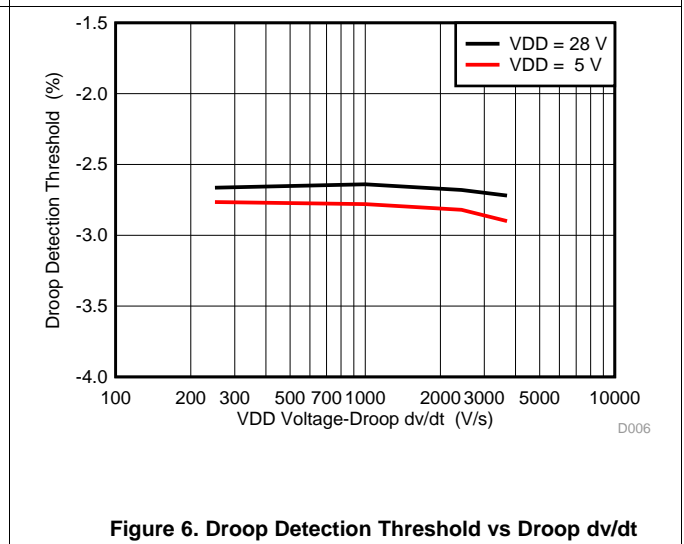
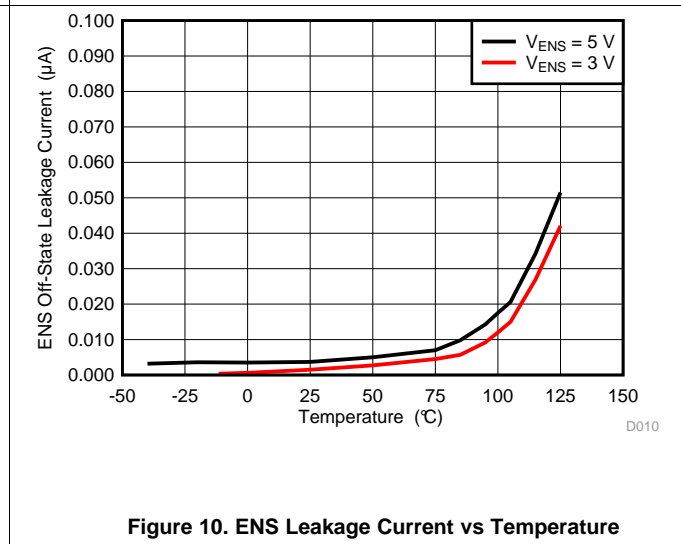
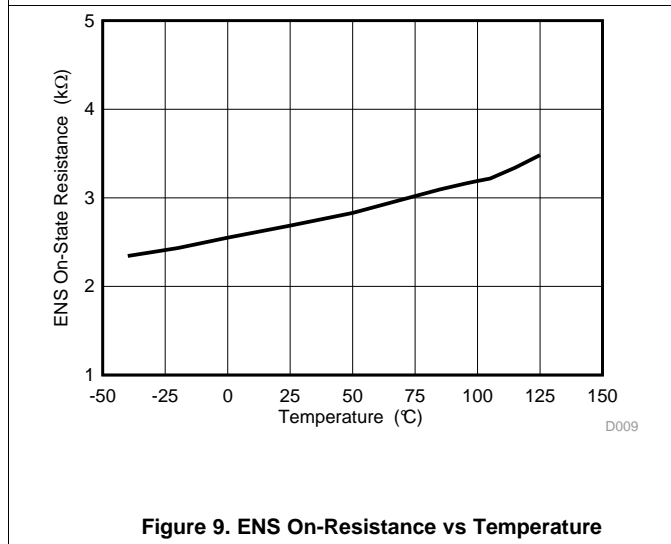
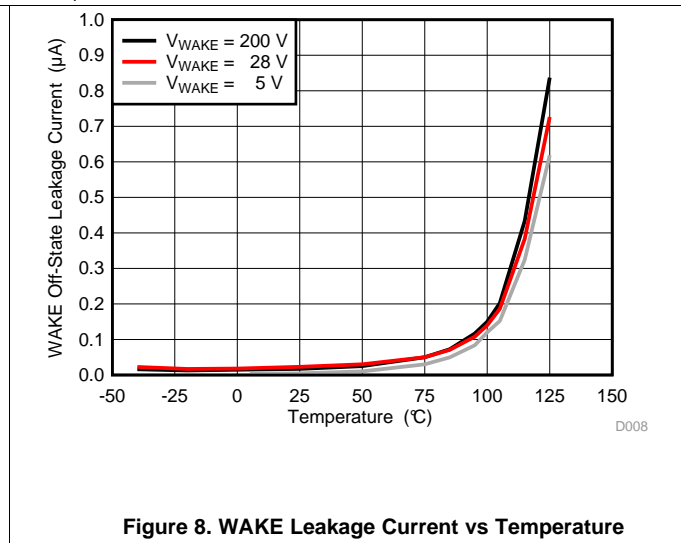
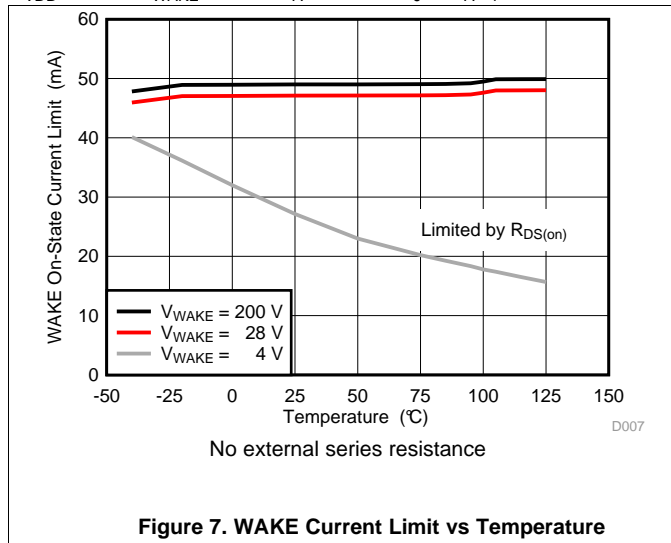

Figure 6. Droop Detection Threshold vs Droop dv/dt

Typical Characteristics (continued)

$V_{VDD} = 5\text{ V}$, $V_{WAKE} = 5\text{ V}$, $T_A = 25^\circ\text{C}$, $T_J = T_A$, (unless otherwise noted)



7 Detailed Description

7.1 Overview

The UCC24650 is a voltage monitor designed to alert a companion primary-side controller device when the monitor detects a relative droop of approximately 3% on its VDD input. Commonly known as a *wake-up* device, the UCC24650 is normally used in isolated-flyback power supply applications using primary-side regulation (PSR). Because the PSR controller may operate at very-low frequencies during light-load or no-load conditions, it cannot detect a sudden load step that may occur between power cycles and the output voltage may fall out of regulation. The UCC24650 can detect the voltage droop and *wake-up* a compatible PSR controller to increase its switching frequency before the output falls too low. This action significantly reduces the amount of output capacitance needed to achieve an acceptable transient response.

At the end of each power cycle delivered by the PSR controller, the UCC24650 droop monitor refreshes an internally stored voltage scaled to 97% of the VDD voltage. If the monitor detects a droop of VDD to the level of the stored voltage, the WAKE signal is connected to GND by an internal low-impedance switch. The WAKE signal transmits a current pulse across the isolation transformer to a compatible PSR controller, such as the UCC28730, capable of detecting the *wake-up* signal on the primary side of the transformer.

The UCC24650 is also capable of disabling a compatible SR controller, such as the UCC24610, during light-load conditions to minimize standby power. The ENS output signal is driven *low* after a fixed sustained count of low-frequency power pulses, and can re-enable the SR controller after a cumulative count of 32 higher-frequency power pulses. The ENS output may also be used to drive other secondary circuitry compatible with the ENS operating parameters.

7.2 Functional Block Diagram

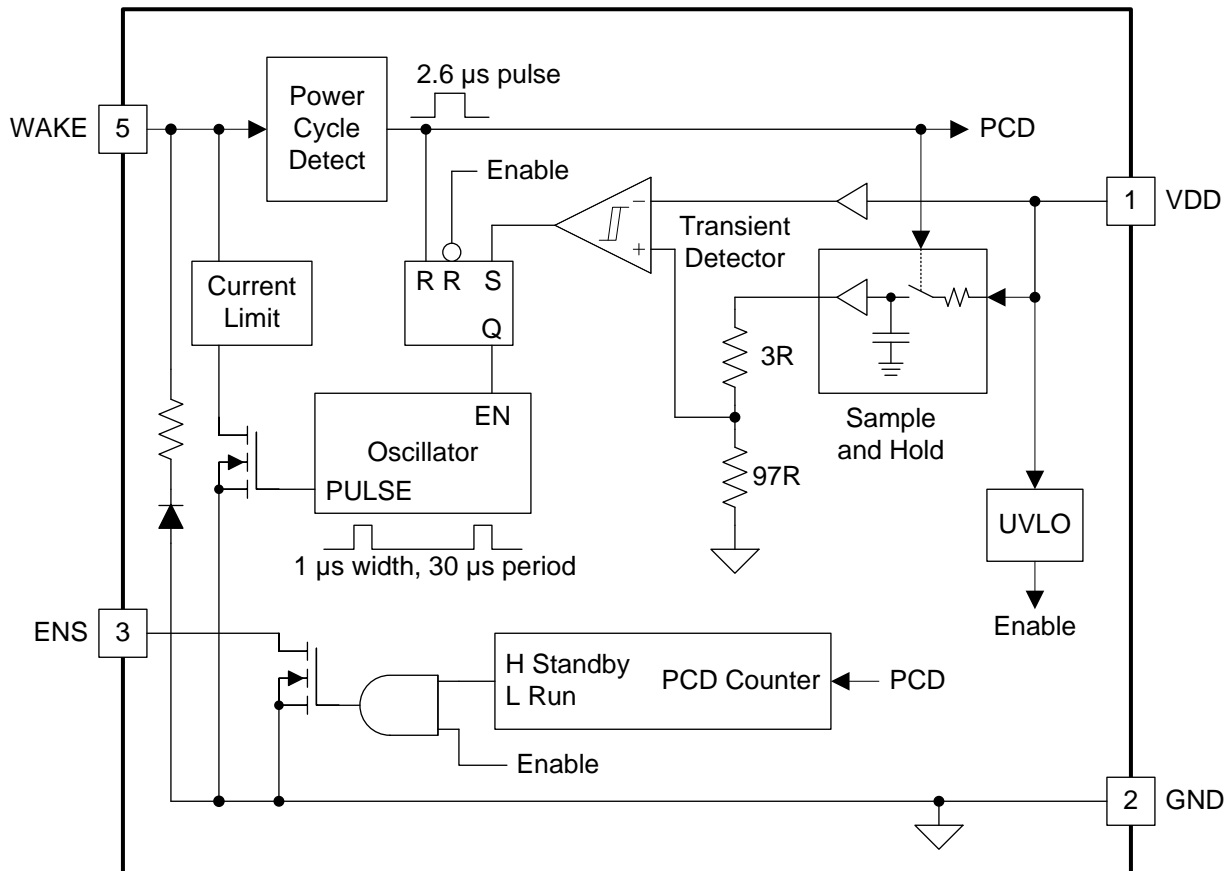

7.3 Feature Description

7.3.1 UVLO Block

The UCC24650 device can operate over a bias supply voltage range from approximately 4 to 28 V. All functions are disabled and bias supply current is quiescent until the UVLO turn-on threshold is exceeded. When enabled, all functions remain operational until the VDD voltage falls below the UVLO turn-off threshold.

To ensure that *wake-up* pulses can be successfully driven, make sure the output voltage droop at VDD during a load-step does not fall below the maximum UVLO turn-off threshold before at least one *wake-up* pulse can be issued. This imposes a practical limit on the lowest nominal no-load voltage allowable at VDD before the maximum load step is applied.

7.3.2 PCD

After the UCC24650 has been turned on and enabled, the WAKE pin is used to detect the power-cycle waveforms at the flyback transformer secondary winding. This winding voltage can be at wide-ranging levels, but the PCD block arms the sample-and-hold (S&H) block to acquire a reference voltage reading at VDD when certain criteria are met. The PCD block triggers the S&H block at the end of the demagnetization time, t_{DM} , provided that the voltage at WAKE has remained below the V_{PCD} threshold for longer than $t_{PCD(min)}$, to ensure that the sampled voltage is free of transient deviations and noise. Consequently, this imposes a minimum demagnetization-time constraint on the flyback design to provide adequate signal for the PCD function.

Figure 11 illustrates the behavior of the device for power-cycles that do meet the criteria and for those that do not. The *wake-up* reference voltage, which is stored internally as approximately 97% of the sampled VDD voltage, is updated at every PCD pulse to change proportionally with the changes in output voltage. Disturbances at the WAKE input which do not meet the PCD criteria do not affect the stored reference voltage.

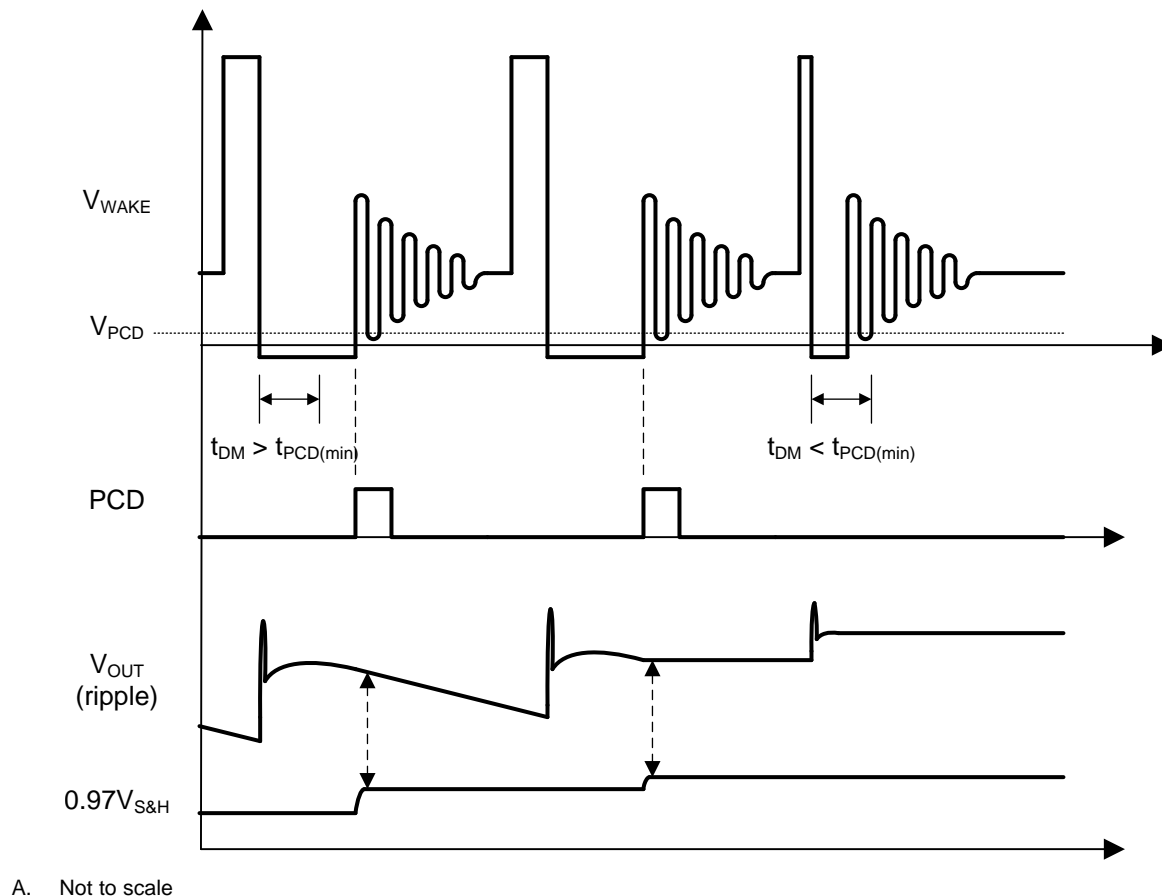
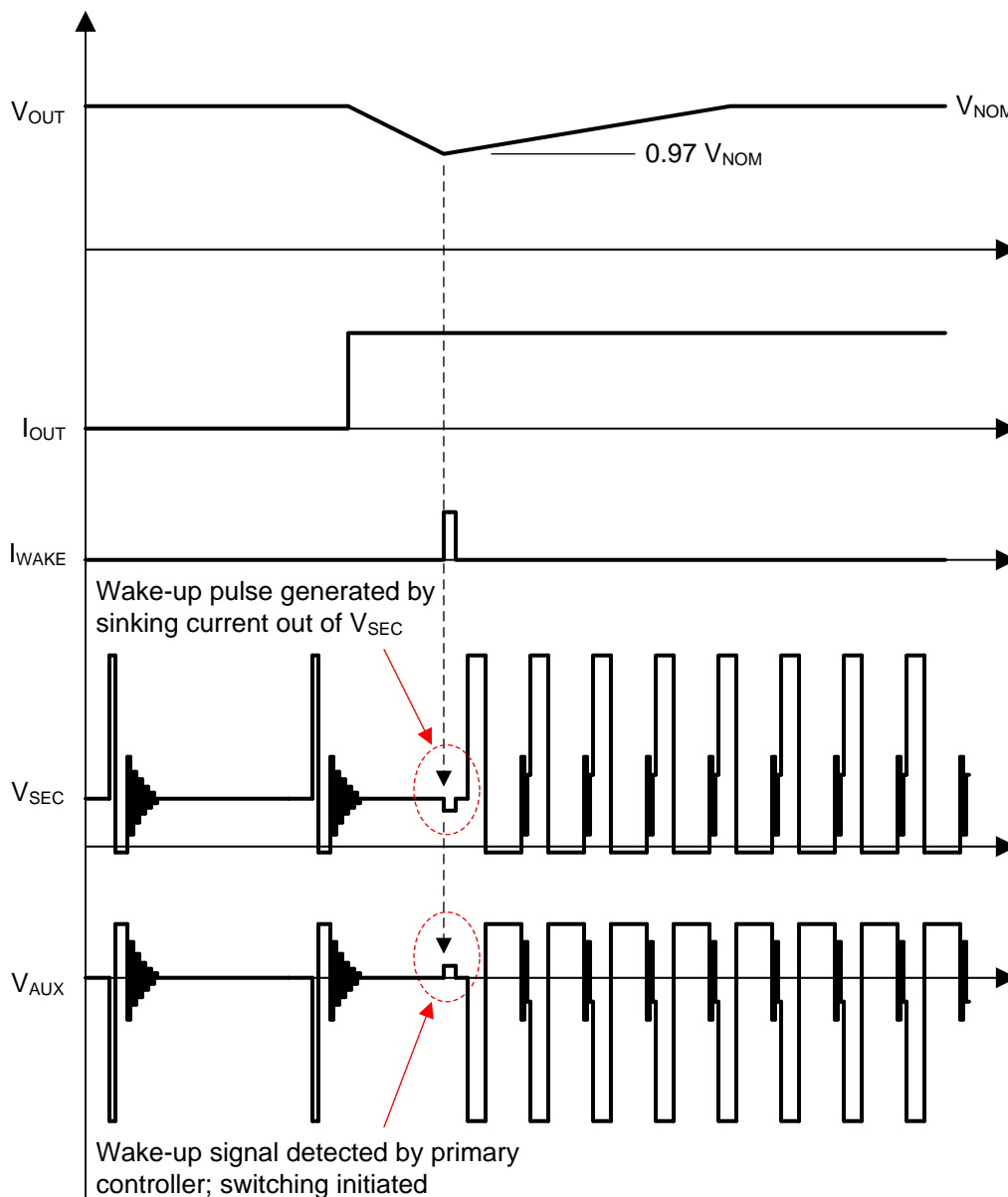

Figure 11. Timing Diagram of Internal PCD Signal

Feature Description (continued)



A. Not to scale

Figure 12. Simplified Timing Diagram of System Behavior

7.3.3 Sample, Hold, and Transient Detector

The sample-and-hold function (S&H) monitors the VDD voltage, samples that voltage during a PCD pulse, and holds the buffered sample constant during the interval between power cycles. The held sample is scaled to about 97% of the external voltage to serve as a –3% droop-detection threshold reference voltage. The external VDD voltage is continually compared to the internal droop reference by the transient detection comparator, and a *wake-up* signal is triggered if VDD falls below the droop-reference voltage.

The S&H droop-reference voltage is refreshed at the end of each power cycle detected by the PCD function, to track minor changes in output voltage. The droop-reference voltage is held accurately for PCD intervals less than $t_{SW(max)}$, but may drift either higher or lower during longer intervals.

Feature Description (continued)

7.3.4 Wake Pulse Generator and WAKE Switch

The WAKE pin not only functions as a PCD input as described in [PCD](#), but also serves as an output driver to accomplish the *wake-up* function. An integrated N-channel MOSFET switch is connected between WAKE and GND and is driven by the WAKE-pulse oscillator when the conditions for *wake-up* are met (see [Functional Block Diagram](#)). Each *wake-up* pulse is of short duration to limit internal dissipation and is repeated periodically until a PSR-driven power cycle is detected or until VDD has fallen to the UVLO turn-off threshold.

[Figure 13](#) shows two possible typical system responses. The solid lines indicate the successful *wake-up* of a compatible PSR controller from the *sleeping* or *Wait* state between low-frequency power cycles. After a load step causes the output voltage (at VDD) to cross the previously stored reference voltage, the WAKE output drives a current pulse to the PSR controller which responds with multiple power cycles to restore regulation. At each power cycle, the reference voltage is refreshed and further WAKE pulses are suppressed. In the case where the PSR controller does not respond to the first *wake-up* pulse, the dotted lines indicate that the *wake-up* pulses are repeated, the reference voltage is not refreshed, and the output voltage continues to fall.

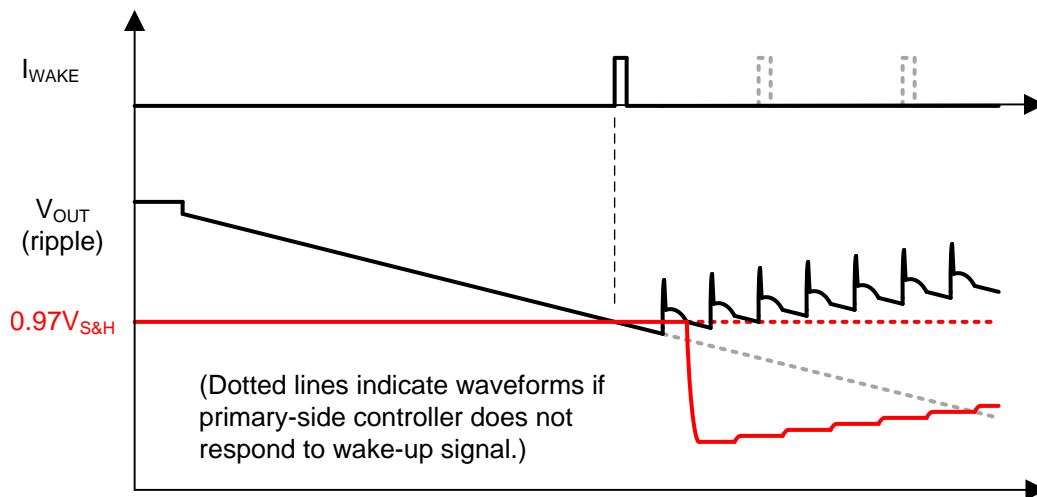

Figure 13. System Response to Wake-Up Signal After Load-Transient Event

In the event that a power cycle occurs during the droop before V_{OUT} has reached the WAKE threshold, the S&H reference is updated to the V_{OUT} voltage at that moment. This may extend the droop by another 3% before the WAKE threshold is reached and the condition for a *wake-up* signal is met, effectively delaying the *wake-up* as illustrated by [Figure 14](#) and [Figure 15](#).

Feature Description (continued)

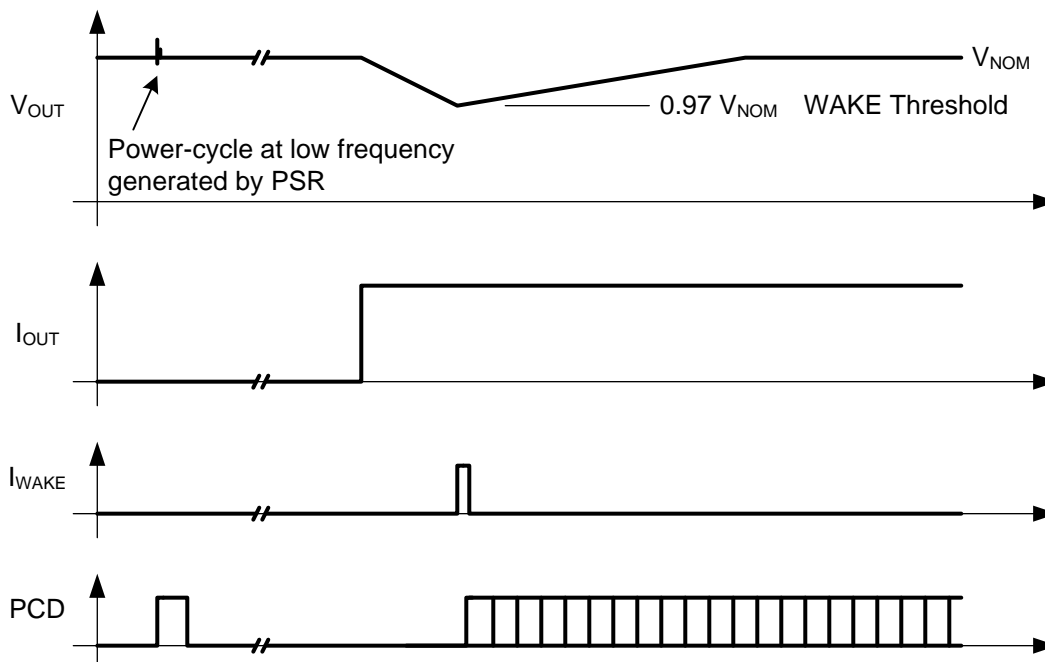

Figure 14. Simplified Typical System Response to Wake-Up Signal After Load-Transient Event

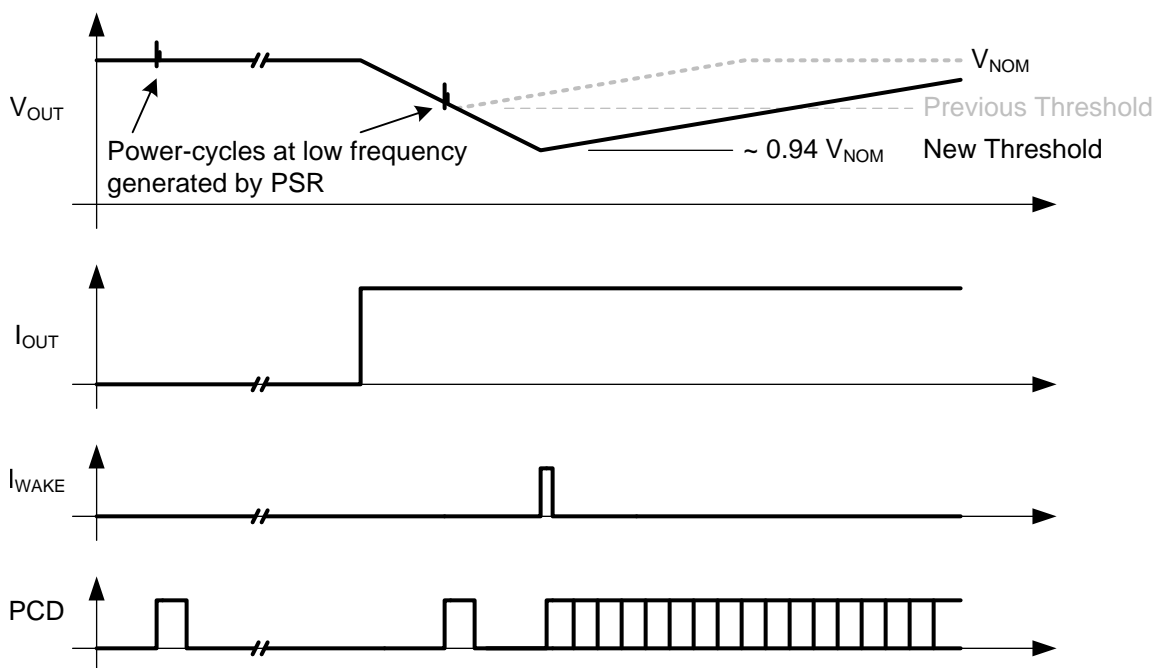

Figure 15. Simplified Delayed System Response to Wake-Up Signal After Load-Transient Event

The typical on-state resistance of the WAKE switch is approximately 150 Ω at 25°C and varies with junction temperature. Consequently, the wake-pulse current capability in low-voltage applications also varies with temperature (see Figure 7 in the *Typical Characteristics*). A built-in current limit prevents excess pulse current and power dissipation in higher-voltage applications.

Feature Description (continued)

In a typical isolated-flyback PSR topology, the wake-pulse current establishes a signal voltage across the system impedance, which consists mainly of the parallel combination of the primary magnetizing inductance, L_M , and the switched-node capacitance, C_{SWN} , scaled by the transformer turns-ratio.

In applications with higher output voltages, some rectifier diodes may exhibit high forward voltage drop characteristics, along with possible additional voltage due to package inductance and stray inductance. This negative forward voltage is impressed on the WAKE input with respect to GND, as shown in [Figure 16](#).

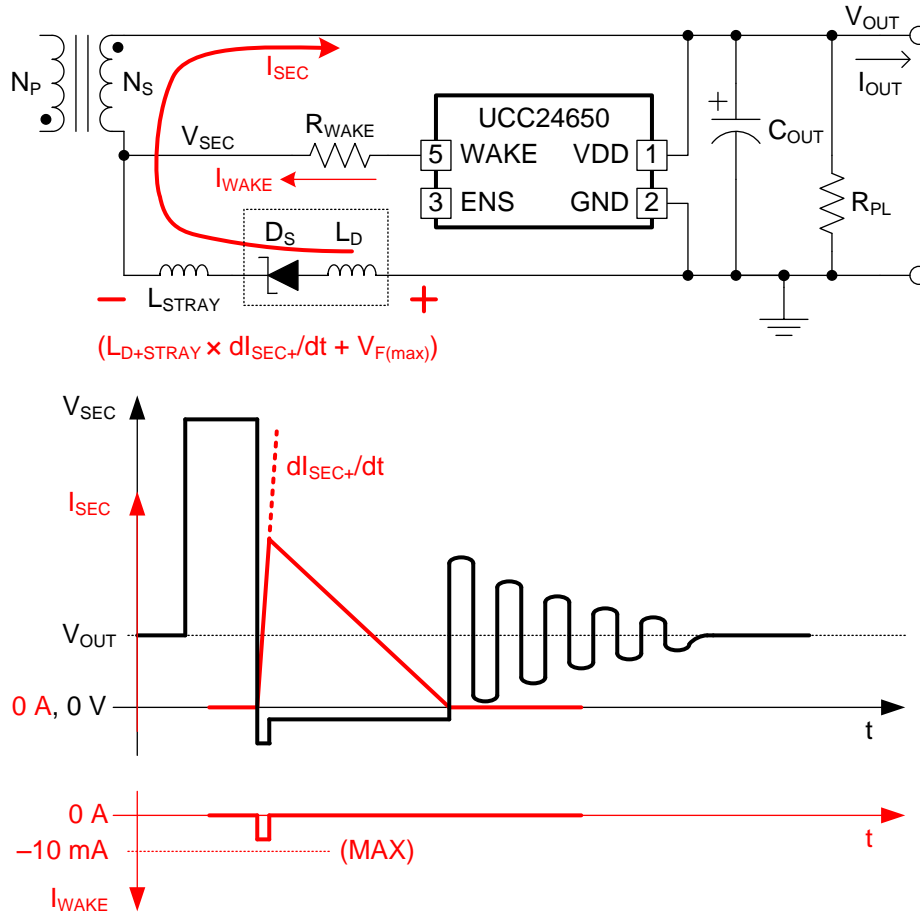

Figure 16. High dI_{SEC+}/dt may Generate Significant I_{WAKE} .

To avoid exceeding the maximum source-current rating for WAKE (see [Absolute Maximum Ratings](#)), a series resistance may be required to limit the WAKE current. Its value is calculated by [Equation 1](#). However, this resistance presents additional impedance to the WAKE signal current that can be developed. Do not oversize R_{WAKE} to avoid depressing the *Wake-Up* signal level at the PSR detection input. A trade-off between the level of reverse-current limiting and the WAKE signal drive level may be necessary.

$$R_{WAKE} \geq \frac{(V_{F(max)} + L_{SUM} dI_{SEC+} / dt) - 0.7 \text{ V}}{10 \text{ mA}}$$

where

- $V_{F(max)}$ is the highest forward voltage drop expected.
- L_{SUM} is the combined stray and package inductance.

(1)

Feature Description (continued)

7.3.5 PCD Counter and ENS Switch

Some PSR applications may use an SR in place of the output diode rectifier to improve efficiency. For applications using the UCC24610 SR controller, the UCC24650 device provides the ENS output which can be used to enable the SR controller when the switching frequency is high, and disable it when the switching frequency is very low, to reduce standby power dissipation. Although the ENS function is specifically optimized for use with the UCC24610 device, it may also be used for other purposes provided the ENS pin is operated within its specified limits.

The ENS output consists of an open-drain, N-channel MOSFET switch with on-resistance of approximately 2.7 k Ω at 25°C. A PCD counter (see [Functional Block Diagram](#)) monitors the time intervals between pulses and determines whether to turn on or off the ENS switch. At power-up, the ENS switch is off (high-impedance open-drain state) by default, and remains that way as long as the power-cycle period, t_{SW} , is less than the disable qualifying interval, t_{DISS} , to keep the SR controller enabled. After $t_{SW} > t_{DISS}$ for a count of at least 63 consecutive power cycles, the ENS switch is turned on (low-impedance to GND) to disable the SR controller. This disable-count is reset to zero if any switching cycle period occurs where $t_{SW} < t_{DISS}$. This consecutive count requirement ensures that the switching frequency is consistently low enough to justify disabling the SR controller to minimize its bias power.

There is considerable hysteresis in the qualifying interval timing, so the ENS switch remains on (SR or other secondary circuit is disabled) until t_{SW} becomes less than the enable qualifying interval, t_{ENS} . In other words, the switching frequency is increasing. When $t_{SW} < t_{ENS}$ for 32 cumulative power cycles, the ENS switch is turned off and the SR controller is enabled. When ENS is in the *Low* state, the cumulative count allows any number of switching cycles with $t_{SW} > t_{ENS}$ without resetting the count. [Figure 17](#) and [Figure 18](#) show these ENS state transitions based on the switching period timing and interval count.

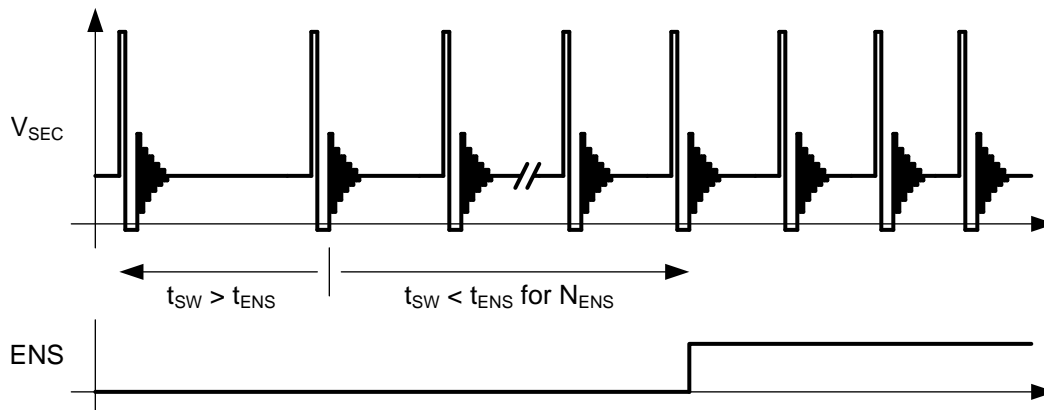

A. Not to scale

Figure 17. Simplified Timing Diagram of ENS Behavior for Gradual Increase of Load

Only 32 shorter t_{SW} intervals are necessary to re-enable the SR controller to avoid excess rectifier dissipation as the system load increases. However, these shorter intervals (higher frequency) are not required to be consecutive, so that ENS is allowed to toggle *High* eventually, even if the switching frequency is not yet consistently higher. This method ensures that the SR or other circuitry is not prevented from re-enabling if the frequency is not consistent due to variable loads.

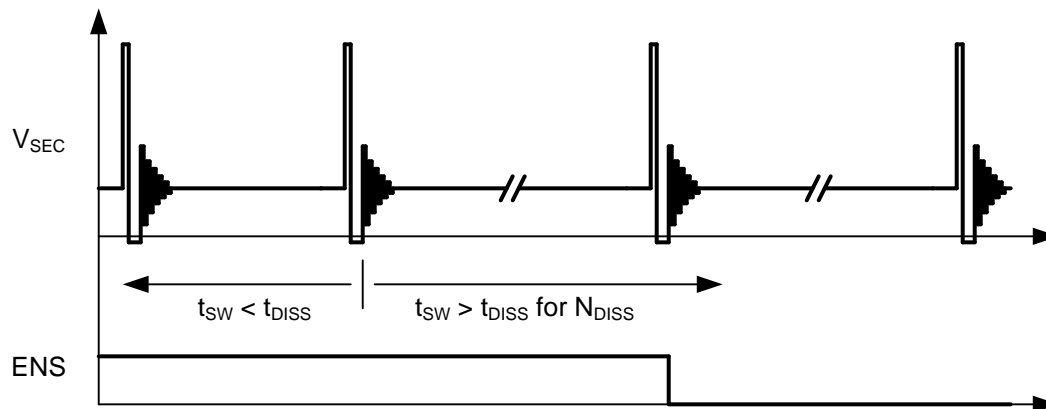
Feature Description (continued)

A. Not to scale

Figure 18. Simplified Timing Diagram of ENS Behavior for Gradual Decrease of Load

At least 63 consecutive counts of $t_{SW} > t_{DISS}$ are necessary to disable the SR controller, to ensure that random deviations in t_{SW} do not unnecessarily disrupt normal SR operation. In this manner, the ENS function is heavily skewed in favor of keeping the SR controller enabled, unless it is consistently operated at a very-low frequency, particularly during no-load operation. ENS is not affected in the case of a *wake-up* event, and the count is not changed. After a *wake-up*, the switching frequency generally increases quite rapidly, so the ENS switch is turned off to re-enable the SR controller as soon as the count of $t_{SW} < t_{ENS}$ reaches 32. Depending on the previous cumulative switching period history, the time to re-enable the SR controller may be anywhere between 32 switching cycles and immediate.

7.4 Device Functional Modes

The UCC24650 operates as a voltage monitor in either of two modes: ENS output is *High* (driver is off), or ENS output is *Low* (driver is on). In either mode, when the monitor detects a 3% droop in the VDD voltage, it triggers a *Wake-Up* signal on the WAKE pin.

8 Application and Implementation

NOTE

Information in the following applications sections is not part of the TI component specification, and TI does not warrant its accuracy or completeness. TI's customers are responsible for determining suitability of components for their purposes. Customers should validate and test their design implementation to confirm system functionality.

8.1 Application Information

The UCC24650 *Wake-Up* monitor is intended to be used with the UCC28730 PSR controller in off-line isolated DCM flyback converters. The UCC24650 signals the UCC28730 that the output voltage has drooped. This allows the PSR controller to react to a load increase even while operating at extremely-low switching frequencies. This pair of devices also operates at very-low bias currents to facilitate the achievement of <5 mW of input power consumption during the no-load operating condition.

8.2 Typical Application

A typical application for the UCC24650 uses the compatible UCC28730 PSR controller to regulate an isolated low-voltage DC output from a high-voltage AC source. As shown in [Figure 19](#) and [Figure 20](#), the output rectification can use a ground-referenced diode, or a ground-referenced synchronous rectifier, respectively.

NOTE

These figures are simplified to illustrate the basic application of the UCC24650 and do not show all of the components and networks needed for an actual converter design.

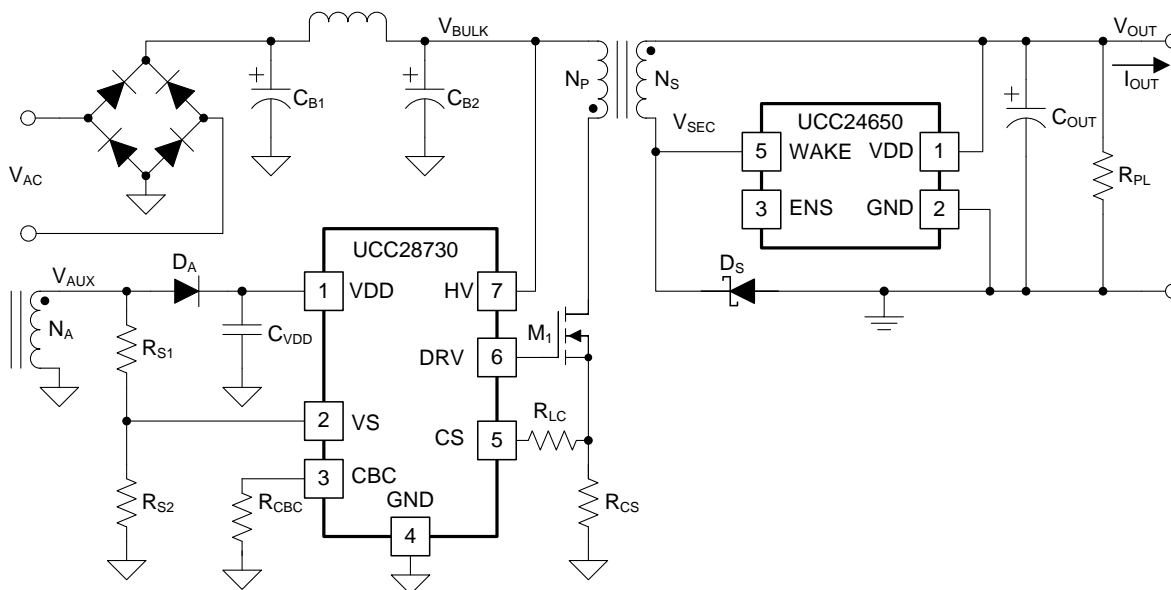

Figure 19. Simplified Application With Ground-Referenced Diode

Typical Application (continued)

8.2.3 Application Curves

The following figures indicate the transient response of a 5-V, 10-W flyback converter which receives a pulsed step-load of 2 A while operating in the no-load standby condition. Figure 24 indicates the no-load standby input power consumption achieved by this converter over the full AC input range. Zero-Power operation is achieved while retaining fast transient response to a full load step.

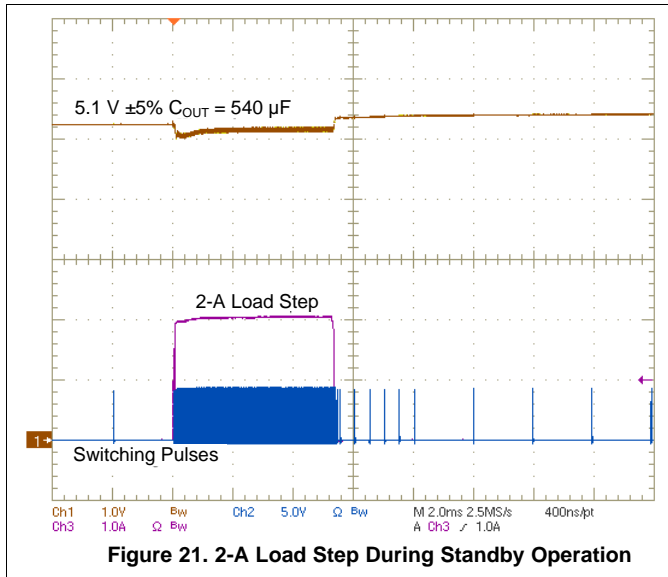

Figure 21. 2-A Load Step During Standby Operation

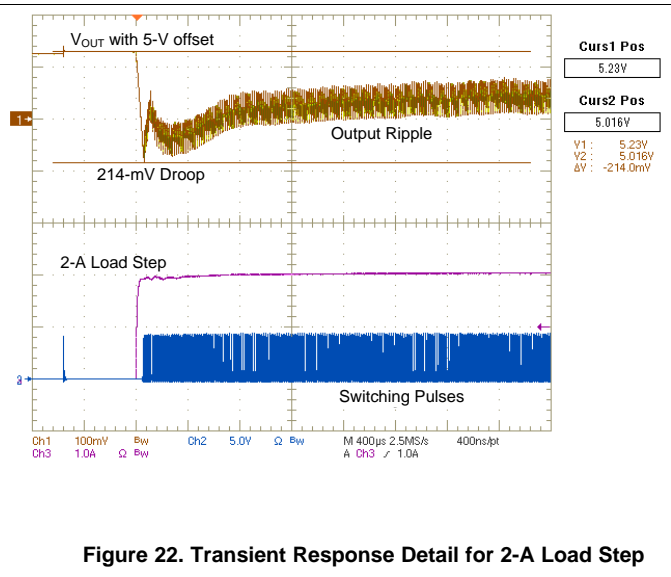

Figure 22. Transient Response Detail for 2-A Load Step

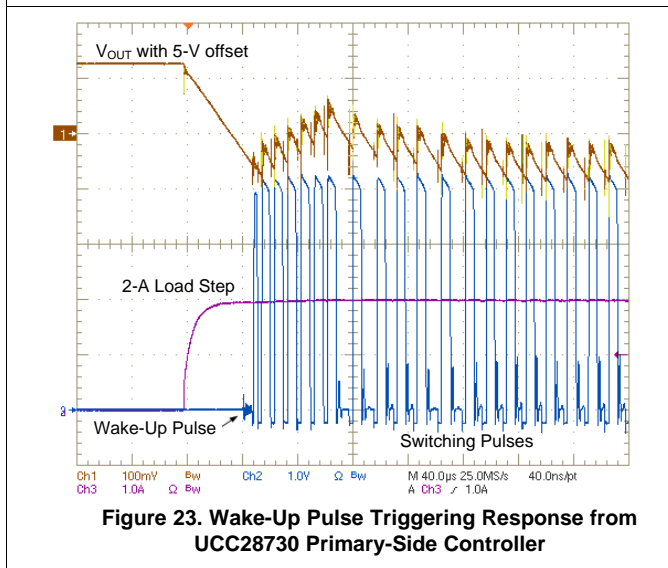

Figure 23. Wake-Up Pulse Triggering Response from UCC28730 Primary-Side Controller

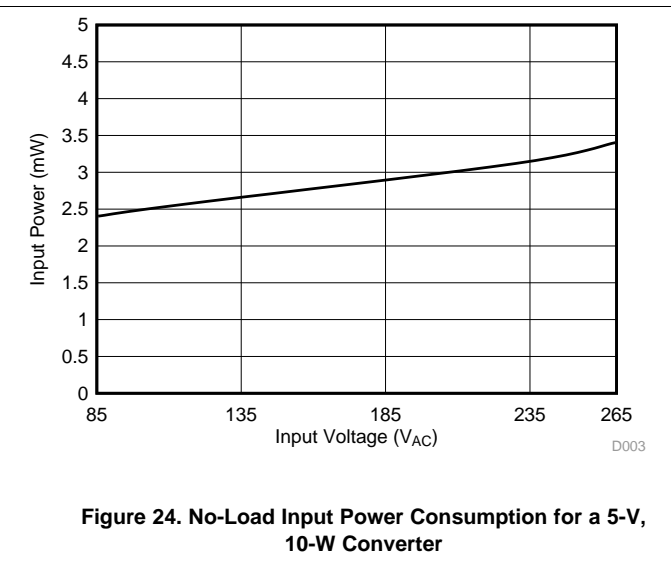

Figure 24. No-Load Input Power Consumption for a 5-V, 10-W Converter

9 Power Supply Recommendations

The VDD pin of the UCC24650 is intended to connect directly to the output voltage of a PSR-flyback converter in the range of 5 to 28 V. Because the device monitors VDD to detect a 3% droop to trigger the *wake-up* function, the converter output voltage should be sufficiently filtered to avoid false trigger from excessive steady-state ripple voltage, relative to the output voltage. The UCC24650 captures its reference voltage at the end of each flyback demagnetization time to avoid the influence of ringing and switching noise. Converter output capacitance should be sufficient to maintain ΔV_{OUT} between switching cycles to less than the droop detection threshold.

Avoid an excessive rate of rise on VDD to ensure correct device operation. Ensure that the $dv/dt < 0.1$ V/ μ s on VDD, or the device may not function until power is removed and restored at a slower rate.

10 Layout

10.1 Layout Guidelines

There are no critical layout requirements. TI recommends to use the usual industry good-practice layout guidelines and principles.

To increase the reliability and feasibility of the project, TI recommends adhering to the following guidelines for PCB layout:

- Connect the WAKE and GND signals close to the output rectifier pads to minimize the effect of high di/dt and stray inductance on the WAKE pin voltage at the beginning of the flyback demagnetization time. It is not so important to minimize the WAKE and GND sense track lengths, rather to minimize the inductance between the two sense points at the rectifier.
- If ENS is not used, connect it to the GND pin to prevent the ENS input voltage from going below GND due to possible system noise.

10.2 Layout Example

The partial layout example of [Figure 25](#) demonstrates an effective component and track arrangement for low-noise operation on a single-layer PCB. Actual board layout must conform to the constraints on a specific design, so many variations are possible.

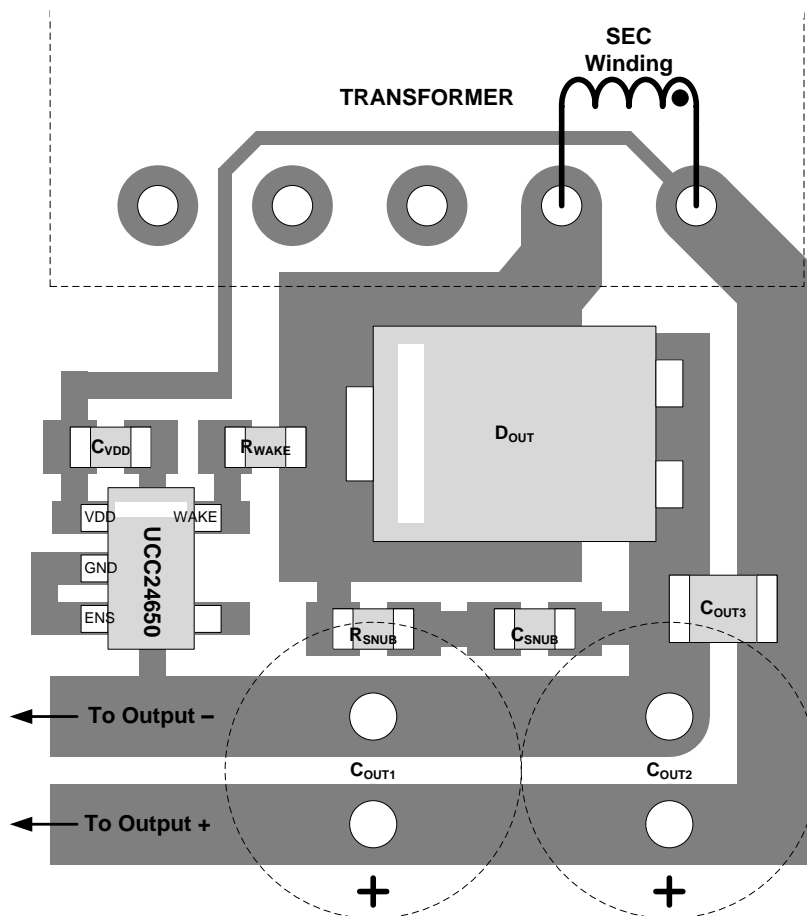

Figure 25. UCC24650 Partial Layout Example

11 Device and Documentation Support

11.1 Documentation Support

11.1.1 Related Documentation

- *UCC28730 Zero-Power Standby PSR Flyback Controller With CVCC and Wake-Up Monitoring*, [SLUSBL5](#)
- *UCC28730EVM-552 EVM user's guide, Using the UCC28730EVM-552*, [SLUUB75](#)

11.2 Trademarks

All trademarks are the property of their respective owners.

11.3 Electrostatic Discharge Caution



These devices have limited built-in ESD protection. The leads should be shorted together or the device placed in conductive foam during storage or handling to prevent electrostatic damage to the MOS gates.

11.4 Glossary

[SLYZ022](#) — *TI Glossary*.

This glossary lists and explains terms, acronyms, and definitions.

12 Mechanical, Packaging, and Orderable Information

The following pages include mechanical, packaging, and orderable information. This information is the most current data available for the designated devices. This data is subject to change without notice and revision of this document. For browser-based versions of this data sheet, refer to the left-hand navigation.

PACKAGING INFORMATION

Orderable Device	Status (1)	Package Type	Package Drawing	Pins	Package Qty	Eco Plan (2)	Lead/Ball Finish (6)	MSL Peak Temp (3)	Op Temp (°C)	Device Marking (4/5)	Samples
UCC24650DBVR	ACTIVE	SOT-23	DBV	5	3000	Green (RoHS & no Sb/Br)	CU NIPDAU	Level-1-260C-UNLIM	-40 to 125	U650	Samples
UCC24650DBVT	ACTIVE	SOT-23	DBV	5	250	Green (RoHS & no Sb/Br)	CU NIPDAU	Level-1-260C-UNLIM	-40 to 125	U650	Samples

(1) The marketing status values are defined as follows:

ACTIVE: Product device recommended for new designs.

LIFEBUY: TI has announced that the device will be discontinued, and a lifetime-buy period is in effect.

NRND: Not recommended for new designs. Device is in production to support existing customers, but TI does not recommend using this part in a new design.

PREVIEW: Device has been announced but is not in production. Samples may or may not be available.

OBSELETE: TI has discontinued the production of the device.

(2) Eco Plan - The planned eco-friendly classification: Pb-Free (RoHS), Pb-Free (RoHS Exempt), or Green (RoHS & no Sb/Br) - please check <http://www.ti.com/productcontent> for the latest availability information and additional product content details.

TBD: The Pb-Free/Green conversion plan has not been defined.

Pb-Free (RoHS): TI's terms "Lead-Free" or "Pb-Free" mean semiconductor products that are compatible with the current RoHS requirements for all 6 substances, including the requirement that lead not exceed 0.1% by weight in homogeneous materials. Where designed to be soldered at high temperatures, TI Pb-Free products are suitable for use in specified lead-free processes.

Pb-Free (RoHS Exempt): This component has a RoHS exemption for either 1) lead-based flip-chip solder bumps used between the die and package, or 2) lead-based die adhesive used between the die and leadframe. The component is otherwise considered Pb-Free (RoHS compatible) as defined above.

Green (RoHS & no Sb/Br): TI defines "Green" to mean Pb-Free (RoHS compatible), and free of Bromine (Br) and Antimony (Sb) based flame retardants (Br or Sb do not exceed 0.1% by weight in homogeneous material)

(3) MSL, Peak Temp. - The Moisture Sensitivity Level rating according to the JEDEC industry standard classifications, and peak solder temperature.

(4) There may be additional marking, which relates to the logo, the lot trace code information, or the environmental category on the device.

(5) Multiple Device Markings will be inside parentheses. Only one Device Marking contained in parentheses and separated by a "~" will appear on a device. If a line is indented then it is a continuation of the previous line and the two combined represent the entire Device Marking for that device.

(6) Lead/Ball Finish - Orderable Devices may have multiple material finish options. Finish options are separated by a vertical ruled line. Lead/Ball Finish values may wrap to two lines if the finish value exceeds the maximum column width.

Important Information and Disclaimer: The information provided on this page represents TI's knowledge and belief as of the date that it is provided. TI bases its knowledge and belief on information provided by third parties, and makes no representation or warranty as to the accuracy of such information. Efforts are underway to better integrate information from third parties. TI has taken and continues to take reasonable steps to provide representative and accurate information but may not have conducted destructive testing or chemical analysis on incoming materials and chemicals. TI and TI suppliers consider certain information to be proprietary, and thus CAS numbers and other limited information may not be available for release.

In no event shall TI's liability arising out of such information exceed the total purchase price of the TI part(s) at issue in this document sold by TI to Customer on an annual basis.

TAPE AND REEL INFORMATION



QUADRANT ASSIGNMENTS FOR PIN 1 ORIENTATION IN TAPE



*All dimensions are nominal

Device	Package Type	Package Drawing	Pins	SPQ	Reel Diameter (mm)	Reel Width W1 (mm)	A0 (mm)	B0 (mm)	K0 (mm)	P1 (mm)	W (mm)	Pin1 Quadrant
UCC24650DBVR	SOT-23	DBV	5	3000	178.0	9.0	3.23	3.17	1.37	4.0	8.0	Q3

TAPE AND REEL BOX DIMENSIONS



*All dimensions are nominal

Device	Package Type	Package Drawing	Pins	SPQ	Length (mm)	Width (mm)	Height (mm)
UCC24650DBVR	SOT-23	DBV	5	3000	180.0	180.0	18.0

EXAMPLE BOARD LAYOUT

DBV0005A

SOT-23 - 1.45 mm max height

SMALL OUTLINE TRANSISTOR



LAND PATTERN EXAMPLE
EXPOSED METAL SHOWN
SCALE:15X

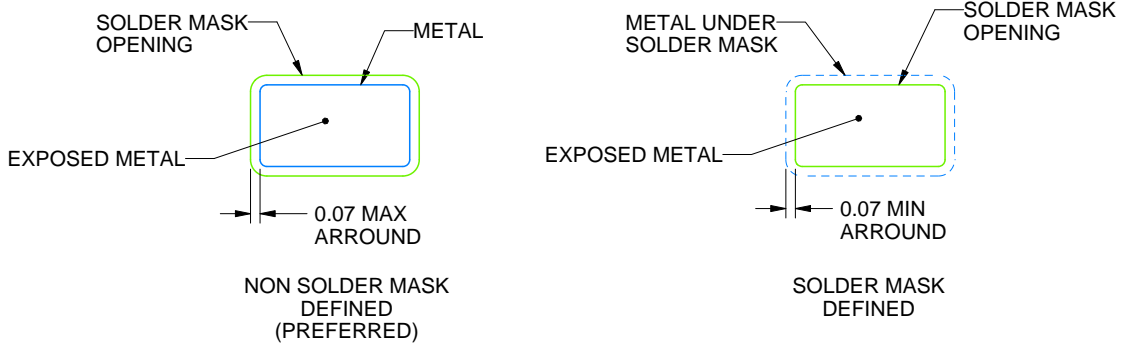

SOLDER MASK DETAILS

4214839/E 09/2019

NOTES: (continued)

- 5. Publication IPC-7351 may have alternate designs.
- 6. Solder mask tolerances between and around signal pads can vary based on board fabrication site.

EXAMPLE STENCIL DESIGN

DBV0005A

SOT-23 - 1.45 mm max height

SMALL OUTLINE TRANSISTOR



SOLDER PASTE EXAMPLE
BASED ON 0.125 mm THICK STENCIL
SCALE:15X

4214839/E 09/2019

NOTES: (continued)

7. Laser cutting apertures with trapezoidal walls and rounded corners may offer better paste release. IPC-7525 may have alternate design recommendations.
8. Board assembly site may have different recommendations for stencil design.

IMPORTANT NOTICE AND DISCLAIMER

TI PROVIDES TECHNICAL AND RELIABILITY DATA (INCLUDING DATASHEETS), DESIGN RESOURCES (INCLUDING REFERENCE DESIGNS), APPLICATION OR OTHER DESIGN ADVICE, WEB TOOLS, SAFETY INFORMATION, AND OTHER RESOURCES "AS IS" AND WITH ALL FAULTS, AND DISCLAIMS ALL WARRANTIES, EXPRESS AND IMPLIED, INCLUDING WITHOUT LIMITATION ANY IMPLIED WARRANTIES OF MERCHANTABILITY, FITNESS FOR A PARTICULAR PURPOSE OR NON-INFRINGEMENT OF THIRD PARTY INTELLECTUAL PROPERTY RIGHTS.

These resources are intended for skilled developers designing with TI products. You are solely responsible for (1) selecting the appropriate TI products for your application, (2) designing, validating and testing your application, and (3) ensuring your application meets applicable standards, and any other safety, security, or other requirements. These resources are subject to change without notice. TI grants you permission to use these resources only for development of an application that uses the TI products described in the resource. Other reproduction and display of these resources is prohibited. No license is granted to any other TI intellectual property right or to any third party intellectual property right. TI disclaims responsibility for, and you will fully indemnify TI and its representatives against, any claims, damages, costs, losses, and liabilities arising out of your use of these resources.

TI's products are provided subject to TI's Terms of Sale (www.ti.com/legal/termsofsale.html) or other applicable terms available either on ti.com or provided in conjunction with such TI products. TI's provision of these resources does not expand or otherwise alter TI's applicable warranties or warranty disclaimers for TI products.

Mailing Address: Texas Instruments, Post Office Box 655303, Dallas, Texas 75265
Copyright © 2019, Texas Instruments Incorporated