



Standard Rectifier

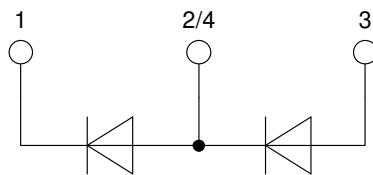
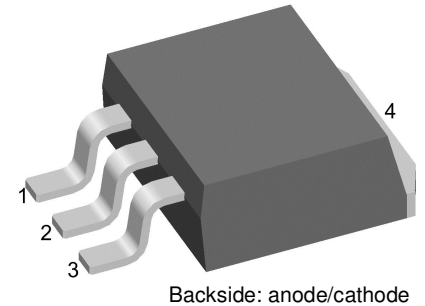
$V_{RRM} = 2 \times 1200 \text{ V}$
 $I_{FAV} = 8 \text{ A}$
 $V_F = 1.08 \text{ V}$

Phase leg

Part number

DSP8-12AS

Marking on Product: DSP8-12AS



Features / Advantages:

- Planar passivated chips
- Very low leakage current
- Very low forward voltage drop
- Improved thermal behaviour

Applications:

- Diode for main rectification
- For single and three phase bridge configurations

Package: TO-263 (D2Pak)

- Industry standard outline
- RoHS compliant
- Epoxy meets UL 94V-0

Disclaimer Notice

Information furnished is believed to be accurate and reliable. However, users should independently evaluate the suitability of and test each product selected for their own applications. Littelfuse products are not designed for, and may not be used in, all applications. Read complete Disclaimer Notice at www.littelfuse.com/disclaimer-electronics.

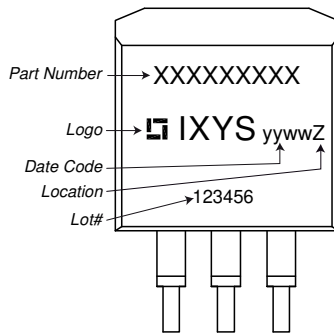


Rectifier				Ratings			
Symbol	Definition	Conditions		min.	typ.	max.	Unit
V_{RSM}	max. non-repetitive reverse blocking voltage					1300	V
V_{RRM}	max. repetitive reverse blocking voltage					1200	V
I_R	reverse current	$V_R = 1200$ V		$T_{VJ} = 25^\circ\text{C}$		10	μA
		$V_R = 1200$ V		$T_{VJ} = 150^\circ\text{C}$		0.2	mA
V_F	forward voltage drop	$I_F = 8$ A		$T_{VJ} = 25^\circ\text{C}$		1.16	V
		$I_F = 16$ A				1.35	V
		$I_F = 8$ A		$T_{VJ} = 150^\circ\text{C}$		1.08	V
		$I_F = 16$ A				1.34	V
I_{FAV}	average forward current	$T_C = 160^\circ\text{C}$		$T_{VJ} = 175^\circ\text{C}$		8	A
		rectangular	d = 0.5				
V_{FO}	threshold voltage			$T_{VJ} = 175^\circ\text{C}$		0.79	V
r_F	slope resistance	} for power loss calculation only				30	m Ω
R_{thJC}	thermal resistance junction to case					1.5	K/W
R_{thCH}	thermal resistance case to heatsink				0.25		K/W
P_{tot}	total power dissipation			$T_C = 25^\circ\text{C}$		100	W
I_{FSM}	max. forward surge current	t = 10 ms; (50 Hz), sine		$T_{VJ} = 45^\circ\text{C}$		120	A
		t = 8,3 ms; (60 Hz), sine		$V_R = 0$ V		130	A
		t = 10 ms; (50 Hz), sine		$T_{VJ} = 150^\circ\text{C}$		100	A
		t = 8,3 ms; (60 Hz), sine		$V_R = 0$ V		110	A
I^2t	value for fusing	t = 10 ms; (50 Hz), sine		$T_{VJ} = 45^\circ\text{C}$		72	A ² s
		t = 8,3 ms; (60 Hz), sine		$V_R = 0$ V		70	A ² s
		t = 10 ms; (50 Hz), sine		$T_{VJ} = 150^\circ\text{C}$		50	A ² s
		t = 8,3 ms; (60 Hz), sine		$V_R = 0$ V		50	A ² s
C_J	junction capacitance	$V_R = 400$ V; f = 1 MHz		$T_{VJ} = 25^\circ\text{C}$		4	pF



Package TO-263 (D2Pak)			Ratings			
Symbol	Definition	Conditions	min.	typ.	max.	Unit
I_{RMS}	RMS current	per terminal			25	A
T_{VJ}	virtual junction temperature		-55		175	°C
T_{op}	operation temperature		-55		150	°C
T_{stg}	storage temperature		-55		150	°C
Weight				1.5		g
F_C	mounting force with clip		20		60	N

Product Marking



Ordering	Ordering Number	Marking on Product	Delivery Mode	Quantity	Code No.
Standard	DSP8-12AS-TRL	DSP8-12AS	Tape & Reel	800	502381
Alternative	DSP8-12AS-TUB	DSP8-12AS	Tube	50	465453

Similar Part	Package	Voltage class
DSP8-12S	TO-263AB (D2Pak) (2)	1200
DSP8-12A	TO-220AB (3)	1200
DSP8-12AC	ISOPLUS220AB (3)	1200
DSP8-08AS	TO-263AA (D2Pak) (3)	800

DSP8-08S	TO-263AB (D2Pak) (2)	800
DSP8-08A	TO-220AB (3)	800

Equivalent Circuits for Simulation

* on die level

$T_{VJ} = 175^{\circ}C$

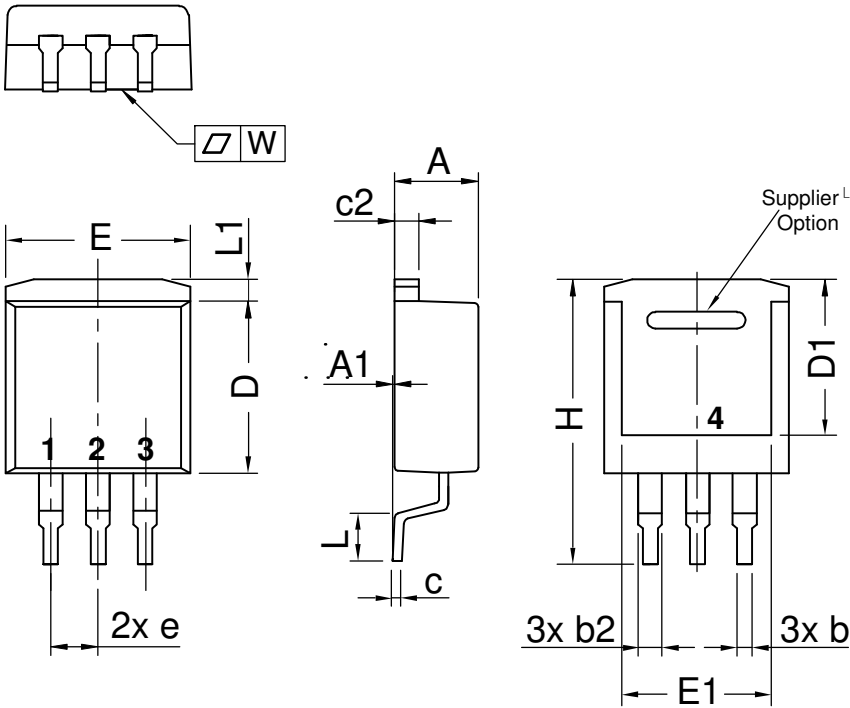


Rectifier

$V_{0\ max}$	threshold voltage	0.79	V
$R_{0\ max}$	slope resistance *	30	mΩ

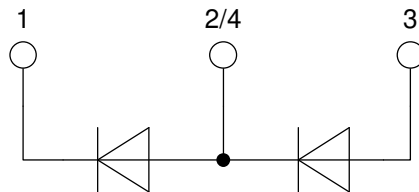


Outlines TO-263 (D2Pak)



Dim.	Millimeter		Inches	
	min	max	min	max
A	4.06	4.83	0.160	0.190
A1	typ. 0.10		typ. 0.004	
A2	2.41		0.095	
b	0.51	0.99	0.020	0.039
b2	1.14	1.40	0.045	0.055
c	0.40	0.74	0.016	0.029
c2	1.14	1.40	0.045	0.055
D	8.38	9.40	0.330	0.370
D1	8.00	8.89	0.315	0.350
D2	2.5		0.098	
E	9.65	10.41	0.380	0.410
E1	6.22	8.50	0.245	0.335
e	2,54 BSC		0,100 BSC	
e1	4.28		0.169	
H	14.61	15.88	0.575	0.625
L	1.78	2.79	0.070	0.110
L1	1.02	1.68	0.040	0.066
W	typ. 0.02	0.040	typ. 0.0008	0.002

All dimensions conform with and/or within JEDEC standard.



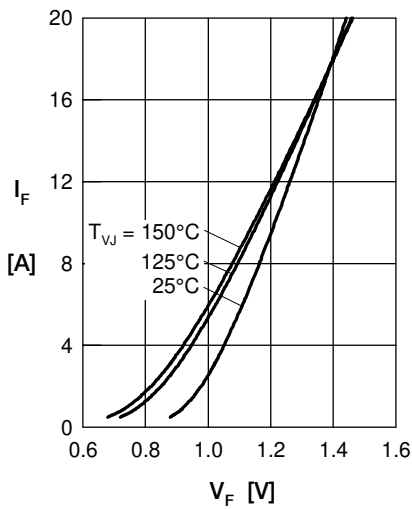
Rectifier


Fig. 1 Forward current versus voltage drop per diode

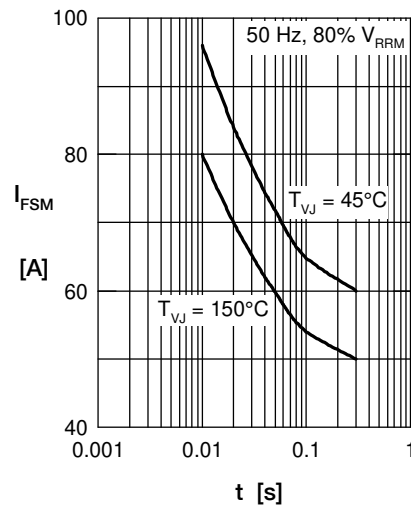


Fig. 2 Surge overload current

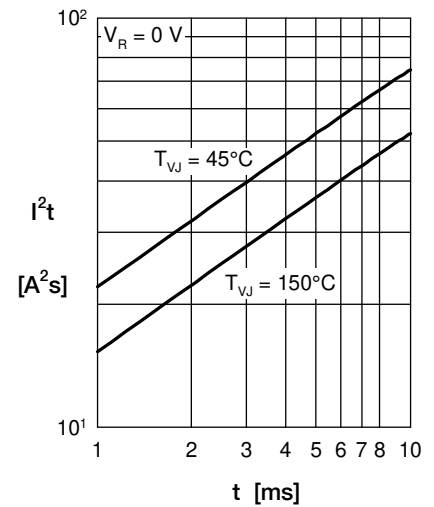
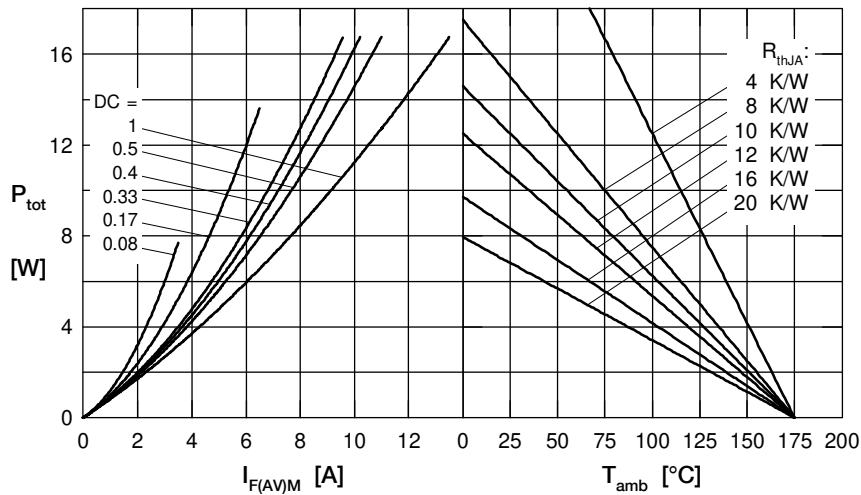

 Fig. 3 I^2t versus time per diode


Fig. 4 Power dissipation vs. direct output current and ambient temperature

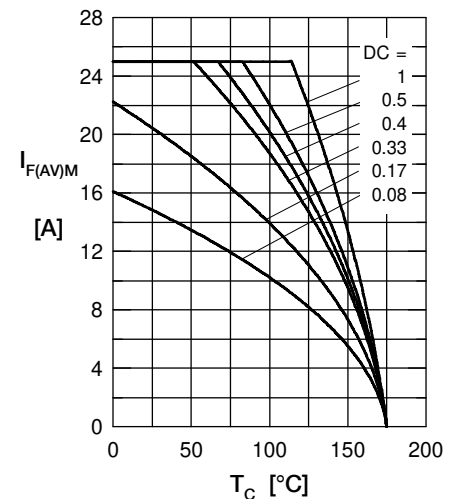


Fig. 5 Max. forward current vs. case temperature

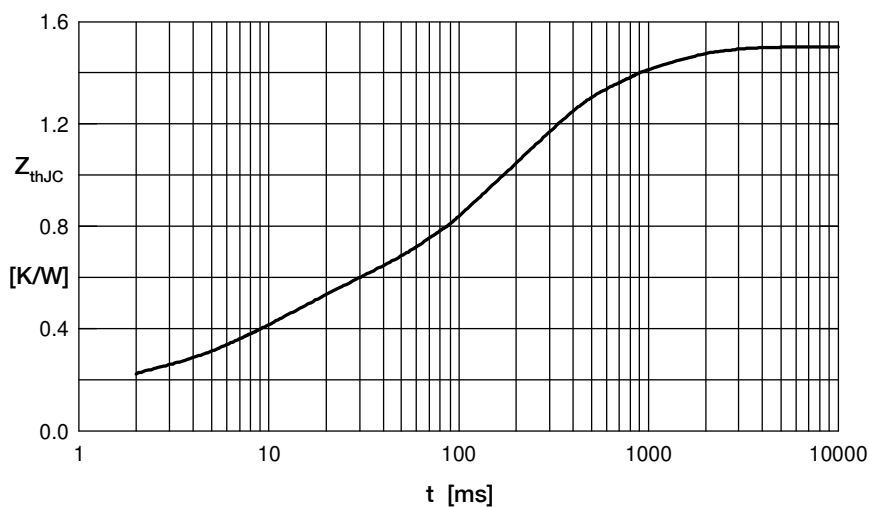


Fig. 6 Transient thermal impedance junction to case

 Constants for Z_{thJC} calculation:

i	R_{thi} (K/W)	t_i (s)
1	0.155	0.0005
2	0.332	0.0095
3	0.713	0.17
4	0.3	0.8
5	0.00001	0.00001