

HA17431 Series

Shunt Regulator

REJ03D0678-0200
 (Previous: ADE-204-049A)
 Rev.2.00
 Jun 15, 2005

Description

The HA17431 series is temperature-compensated variable shunt regulators. The main application of these products is in voltage regulators that provide a variable output voltage. The on-chip high-precision reference voltage source can provide $\pm 1\%$ accuracy in the V versions, which have a V_{KA} max of 16 volts. The HA17431VLP, which is provided in the MPAK-5V package, is designed for use in switching mode power supplies. It provides a built-in photocoupler bypass resistor for the PS pin, and an error amplifier can be easily constructed on the supply side.

Features

- The V versions provide $2.500\text{ V} \pm 1\%$ at $T_a = 25^\circ\text{C}$
- The HA17431VLP includes a photocoupler bypass resistor ($2\text{ k}\Omega$)
- The reference voltage has a low temperature coefficient
- The MPAK-5V(5-pin), MPAKV(3-pin) and UPAKV miniature packages are optimal for use on high mounting density circuit boards
- Car use is provided

Block Diagram

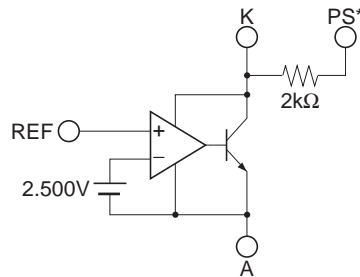

Note: * The PS pin is only provided by the HA17431VLP.

Application Circuit Example

Switching power supply secondary-side error amplification circuit

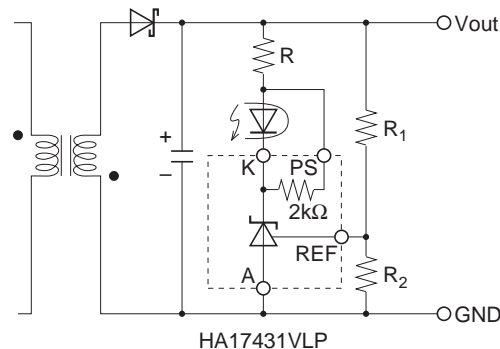

Ordering Information

		Reference voltage (at 25°C)			Package Code (Previous Code)	Operating Temperature Range
		Normal Version ±4% 2.395V to 2.495V to 2.595V	A Version ±2.2% 2.440V to 2.495V to 2.550V	V Version ±1% 2.475V to 2.500V to 2.525V		
	Item					
Car use	HA17431FPAJ		○		PRSP0008DE-B (FP-8DGV)	-40 to +85°C
	HA17431FPJ	○			PRSP0008DE-B (FP-8GDV)	
	HA17431PAJ		○		PRSS0003DC-A (TO-92MODV)	
	HA17431PJ	○			PRSS0003DC-A (TO-92MODV)	
	HA17431PNAJ		○		PRSS0003DA-A (TO-92V)	
	HA17431VPJ			○	PRSS0003DA-A (TO-92V)	
Industrial use	HA17431FP	○			PRSP0008DE-B (FP-8DGV)	-20 to +85°C
	HA17431FPA		○		PRSP0008DE-B (FP-8DGV)	
	HA17431P	○			PRSS0003DC-A (TO-92MODV)	
	HA17431PA		○		PRSS0003DC-A (TO-92MODV)	
	HA17431PNA		○		PRSS0003DA-A (TO-92V)	
	HA17431UPA		○		PLZZ0004CA-A (UPAKV)	
	HA17432UPA		○		PLZZ0004CA-A (UPAKV)	
	HA17431VLP			○	PLSP0005ZB-A (MPAK-5V)	
	HA17431VP			○	PRSS0003DA-A (TO-92V)	
	HA17431VUP			○	PLZZ0004CA-A (UPAKV)	
	HA17432VUP			○	PLZZ0004CA-A (UPAKV)	
	HA17431VLTP			○	PLSP0003ZB-A (MPAKV)	
	HA17432VLTP			○	PLSP0003ZB-A (MPAKV)	
	Commercial use	HA17431UA		○		
HA17432UA			○		PLZZ0004CA-A (UPAKV)	

Pin Arrangement

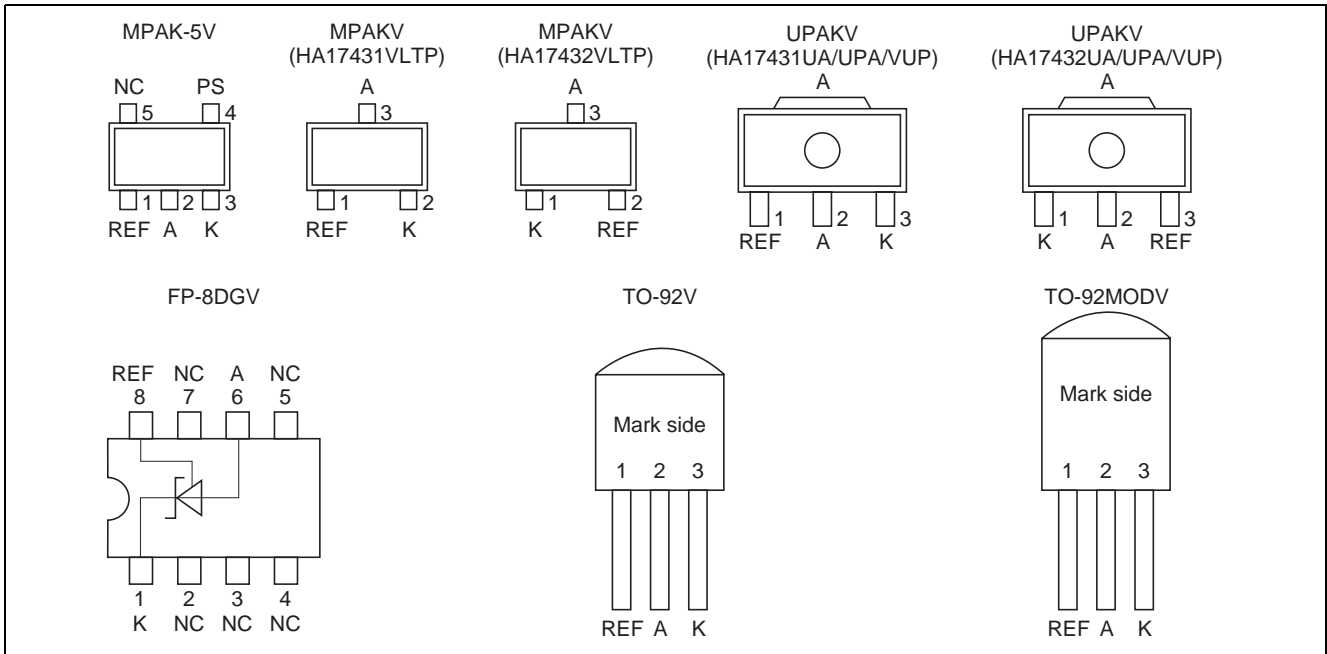

Absolute Maximum Ratings

(Ta = 25°C)

Item	Symbol	HA17431VLP	HA17431VP	HA17431VPJ	Unit	Notes
Cathode voltage	V _{KA}	16	16	16	V	1
PS term. voltage	V _{PS}	V _{KA} to 16	—	—	V	1,2,3
Continuous cathode current	I _K	-50 to +50	-50 to +50	-50 to +50	mA	
Reference input current	I _{ref}	-0.05 to +10	-0.05 to +10	-0.05 to +10	mA	
Power dissipation	P _T	150 * ⁴	500 * ⁵	500 * ⁵	mW	4, 5
Operating temperature range	Topr	-20 to +85	-20 to +85	-40 to +85	°C	
Storage temperature	Tstg	-55 to +150	-55 to +150	-55 to +150	°C	

Item	Symbol	HA17431VUP/HA17432VUP	HA17431VLTP/HA17432VLTP	Unit	Notes
Cathode voltage	V _{KA}	16	16	V	1
PS term. voltage	V _{PS}	—	—	V	1,2,3
Continuous cathode current	I _K	-50 to +50	-50 to +50	mA	
Reference input current	I _{ref}	-0.05 to +10	-0.05 to +10	mA	
Power dissipation	P _T	800 * ⁸	150 * ⁴	mW	4, 8
Operating temperature range	Topr	-20 to +85	-20 to +85	°C	
Storage temperature	Tstg	-55 to +150	-55 to +150	°C	

Item	Symbol	HA17431PNA	HA17431P/PA	HA17431FP/FPA	HA17431UA/UPA/ HA17432UA/UPA	Unit	Notes
Cathode voltage	V _{KA}	40	40	40	40	V	1
Continuous cathode current	I _K	-100 to +150	-100 to +150	-100 to +150	-100 to +150	mA	
Reference input current	I _{ref}	-0.05 to +10	-0.05 to +10	-0.05 to +10	-0.05 to +10	mA	
Power dissipation	P _T	500 * ⁵	800 * ⁶	500 * ⁷	800 * ⁸	mW	5,6,7,8
Operating temperature range	Topr	-20 to +85	-20 to +85	-20 to +85	-20 to +85	°C	
Storage temperature	Tstg	-55 to +150	-55 to +150	-55 to +125	-55 to +150	°C	

Absolute Maximum Ratings (cont.)

(Ta = 25°C)

Item	Symbol	HA17431PNAJ	HA17431PJ/PAJ	HA17431FPJ/FPAJ	Unit	Notes
Cathode voltage	V _{KA}	40	40	40	V	1
Continuous cathode current	I _K	-100 to +150	-100 to +150	-100 to +150	mA	
Reference input current	I _{ref}	-0.05 to +10	-0.05 to +10	-0.05 to +10	mA	
Power dissipation	P _T	500 * ⁵	800 * ⁶	500 * ⁷	mW	5,6,7
Operating temperature range	T _{opr}	-40 to +85	-40 to +85	-40 to +85	°C	
Storage temperature	T _{stg}	-55 to +150	-55 to +150	-55 to +125	°C	

Notes: 1. Voltages are referenced to anode.

2. The PS pin is only provided by the HA17431VLP.

3. The PS pin voltage must not fall below the cathode voltage. If the PS pin is not used, the PS pin is recommended to be connected with the cathode.

4. Ta ≤ 25°C. If Ta > 25°C, derate by 1.2 mW/°C.

5. Ta ≤ 25°C. If Ta > 25°C, derate by 4.0 mW/°C.

6. Ta ≤ 25°C. If Ta > 25°C, derate by 6.4 mW/°C.

7. 50 mm × 50 mm × 1.5mm glass epoxy board(5% wiring density), Ta ≤ 25°C. If Ta > 25°C, derate by 5 mW/°C.

8. 15 mm × 25 mm × 0.7mm alumina ceramic board, Ta ≤ 25°C. If Ta > 25°C, derate by 6.4 mW/°C.

Electrical Characteristics

HA17431VLP/VP/VPJ/VUP/VLTP, HA17432VUP/VLTP

(Ta = 25°C, I_K = 10 mA)

Item	Symbol	Min	Typ	Max	Unit	Test Conditions	Notes
Reference voltage	V _{ref}	2.475	2.500	2.525	V	V _{KA} = V _{ref}	
Reference voltage temperature deviation	V _{ref} (dev)	—	10	—	mV	V _{KA} = V _{ref} , Ta = -20°C to +85°C	1
Reference voltage temperature coefficient	ΔV _{ref} /ΔTa	—	±30	—	ppm/°C	V _{KA} = V _{ref} , 0°C to 50°C gradient	
Reference voltage regulation	ΔV _{ref} /ΔV _{KA}	—	2.0	3.7	mV/V	V _{KA} = V _{ref} to 16 V	
Reference input current	I _{ref}	—	2	6	μA	R ₁ = 10 kΩ, R ₂ = ∞	
Reference current temperature deviation	I _{ref} (dev)	—	0.5	—	μA	R ₁ = 10 kΩ, R ₂ = ∞, Ta = -20°C to +85°C	
Minimum cathode current	I _{min}	—	0.4	1.0	mA	V _{KA} = V _{ref}	2
Off state cathode current	I _{off}	—	0.001	1.0	μA	V _{KA} = 16 V, V _{ref} = 0 V	
Dynamic impedance	Z _{KA}	—	0.2	0.5	Ω	V _{KA} = V _{ref} , I _K = 1 mA to 50 mA	
Bypass resistance	R _{PS}	1.6	2.0	2.4	kΩ	I _{PS} = 1 mA	3
Bypass resistance temperature coefficient	ΔR _{PS} /ΔTa	—	+2000	—	ppm/°C	I _{PS} = 1 mA, 0°C to 50°C gradient	3

HA17431PJ/PAJ/FPJ/FPAJ/P/PA/UA/UPA/FP/FPA/PNA/PNAJ, HA17432UA/UPA

(Ta = 25°C, I_K = 10 mA)

Item	Symbol	Min	Typ	Max	Unit	Test Conditions	Notes
Reference voltage	V _{ref}	2.440	2.495	2.550	V	V _{KA} = V _{ref}	A
		2.395	2.495	2.595			Normal
Reference voltage temperature deviation	V _{ref} (dev)	—	11	(30)	mV	V _{KA} = V _{ref}	Ta = -20°C to +85°C 1, 4
		—	5	(17)			Ta = 0°C to +70°C 1, 4
Reference voltage regulation	ΔV _{ref} /ΔV _{KA}	—	1.4	3.7	mV/V	V _{KA} = V _{ref} to 10 V V _{KA} = 10 V to 40 V	
		—	1	2.2			
Reference input current	I _{ref}	—	3.8	6	μA	R ₁ = 10 kΩ, R ₂ = ∞	
Reference current temperature deviation	I _{ref} (dev)	—	0.5	(2.5)	μA	R ₁ = 10 kΩ, R ₂ = ∞, Ta = 0°C to +70°C	4
Minimum cathode current	I _{min}	—	0.4	1.0	mA	V _{KA} = V _{ref}	2
Off state cathode current	I _{off}	—	0.001	1.0	μA	V _{KA} = 40 V, V _{ref} = 0 V	
Dynamic impedance	Z _{KA}	—	0.2	0.5	Ω	V _{KA} = V _{ref} , I _K = 1 mA to 100 mA	

Notes: 1. V_{ref}(dev) = V_{ref}(max) - V_{ref}(min)

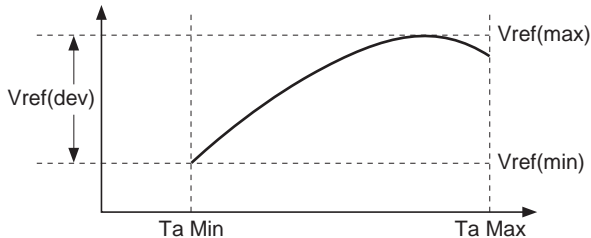

- I_{min} is given by the cathode current at V_{ref} = V_{ref}(I_K=10mA) - 15 mV.
- R_{PS} is only provided in HA17431VLP.
- The maximum value is a design value (not measured).

MPAK-5V(5-pin), MPAKV(3-pin) and UPAKV Marking Patterns

The marking patterns shown below are used on MPAK-5V, MPAKV and UPAKV products. Note that the product code and mark pattern are different. The pattern is laser-printed.

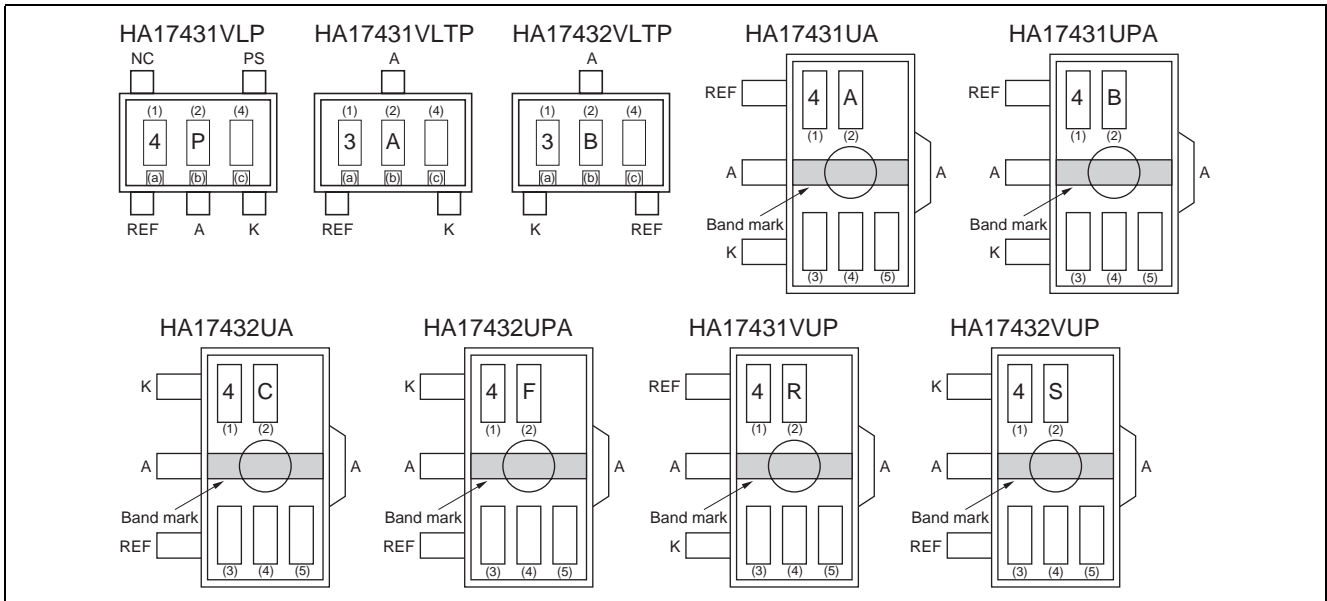

Notes: 1. Boxes (1) to (5) in the figures show the position of the letters or numerals, and are not actually marked on the package.

2. The letters (1) and (2) show the product specific mark pattern.

Product	(1)	(2)
HA17431VLP	4	P
HA17431VUP	4	R
HA17432VUP	4	S
HA17431VLTP	3	A
HA17432VLTP	3	B
HA17431UA	4	A
HA17431UPA	4	B
HA17432UA	4	C
HA17432UPA	4	F

3. The letter (3) shows the production year code (the last digit of the year) for UPAKV products.

4. The bars (a), (b) and (c) show a production year code for MPAK-5V and MPAKV products as shown below. After 2010 the code is repeated every 8 years.

Year	2002	2003	2004	2005	2006	2007	2008	2009
(a)	None	None	None	Bar	Bar	Bar	Bar	None
(b)	None	Bar	Bar	None	None	Bar	Bar	None
(c)	Bar	None	Bar	None	Bar	None	Bar	None

5. The letter (4) shows the production month code (see table below).

Production month	Jan.	Feb.	Mar.	Apr.	May.	Jun.	Jul.	Aug.	Sep.	Oct.	Nov.	Dec.
Marked code	A	B	C	D	E	F	G	H	J	K	L	M

6. The letter (5) shows manufacturing code. For UPAKV products.

Characteristics Curves

HA17431VLP/VP/VPJ/VUP/VLTP, HA17432VUP/VLTP

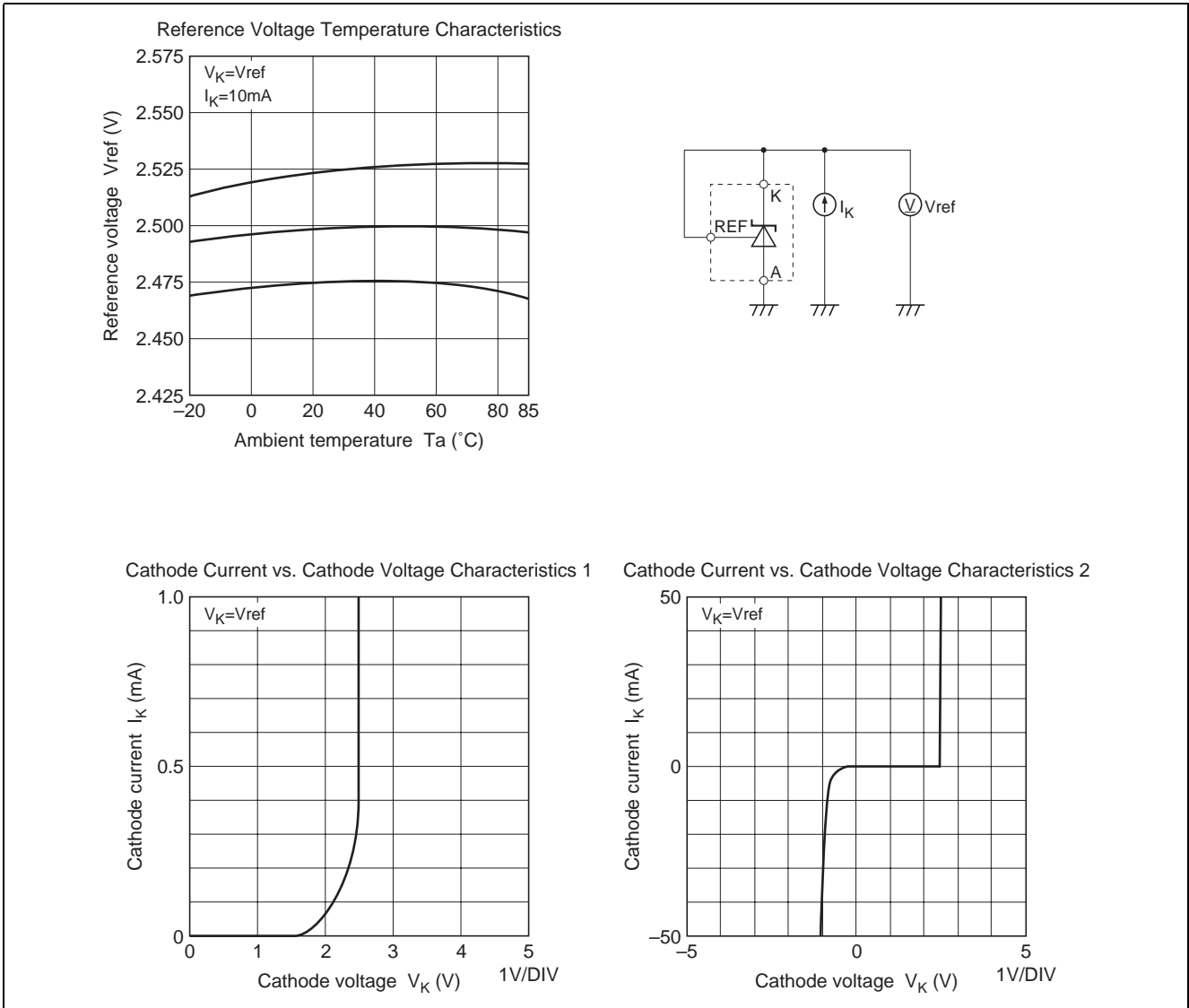

HA17431PJ/PAJ/FPJ/FPAJ/P/PA/UA/UPA/FP/FPA/PNA/PNAJ, HA17432UA/UPA

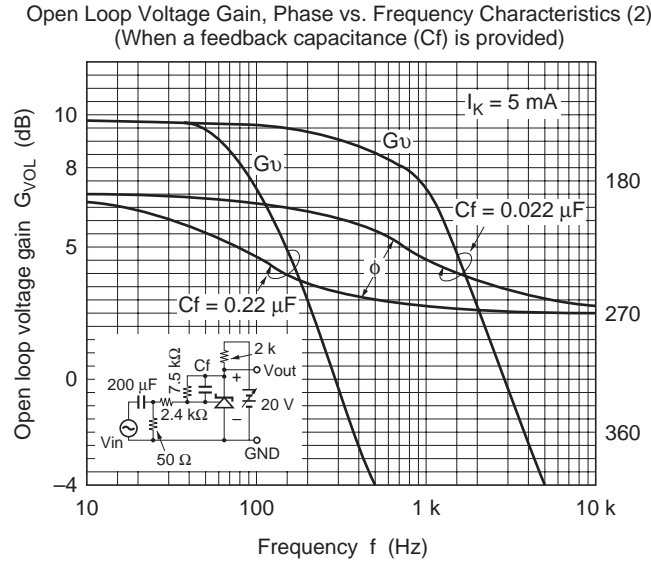
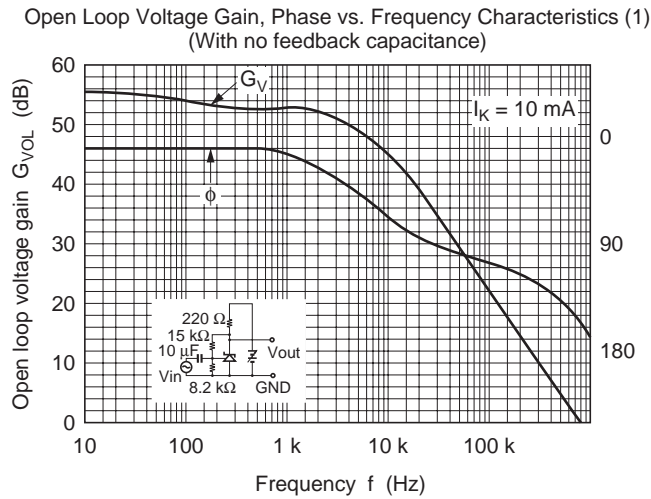
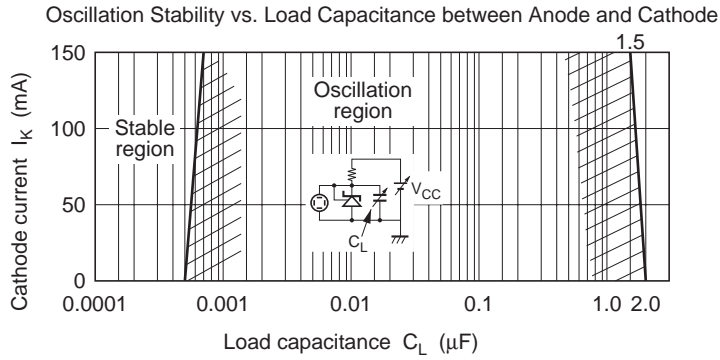

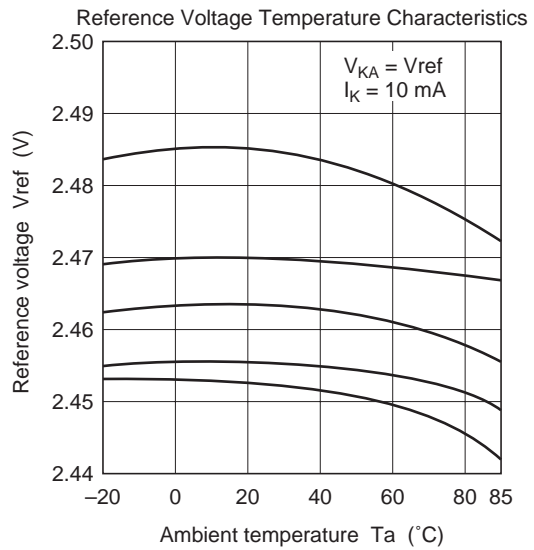
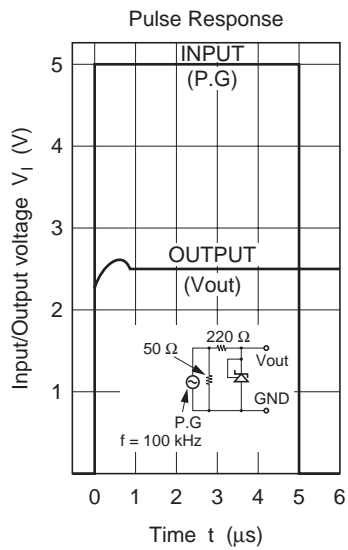
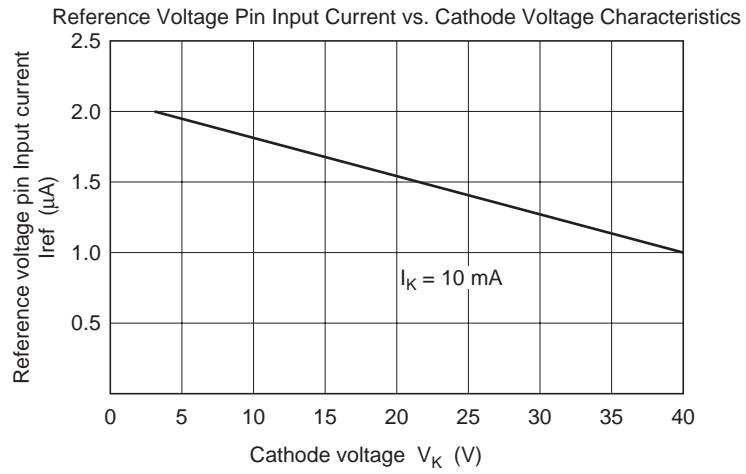

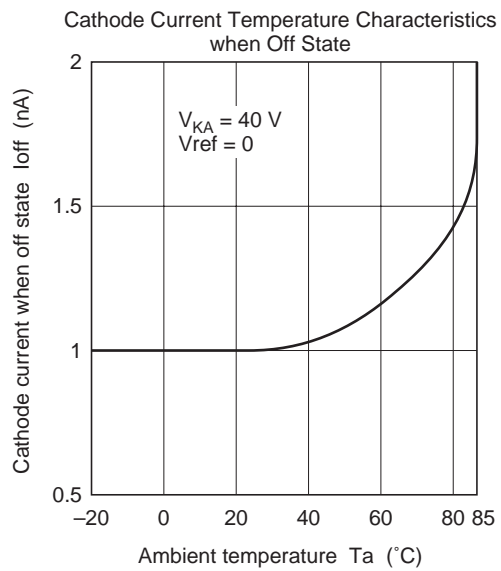
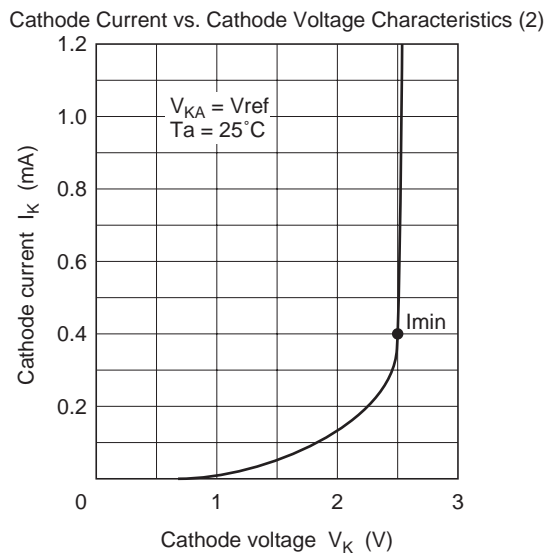
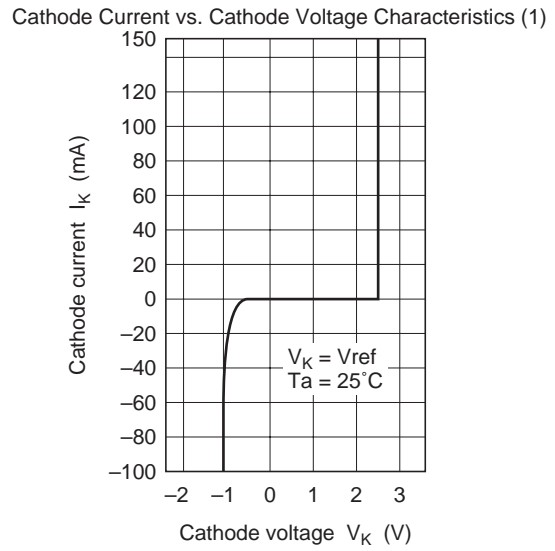
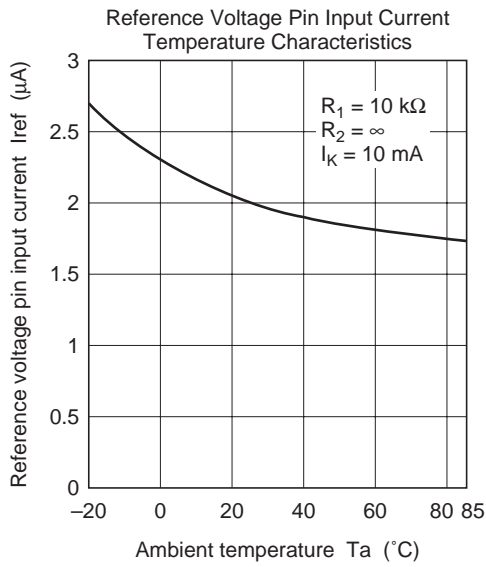

Application Examples

As shown in the figure on the right, this IC operates as an inverting amplifier, with the REF pin as input pin. The open-loop voltage gain is given by the reciprocal of “reference voltage deviation by cathode voltage change” in the electrical specifications, and is approximately 50 to 60 dB. The REF pin has a high input impedance, with an input current I_{ref} of $3.8 \mu\text{A Typ}$ (V version: $I_{ref} = 2 \mu\text{A Typ}$). The output impedance of the output pin K (cathode) is defined as dynamic impedance Z_{KA} , and Z_{KA} is low (0.2Ω) over a wide cathode current range. A (anode) is used at the minimum potential, such as ground.

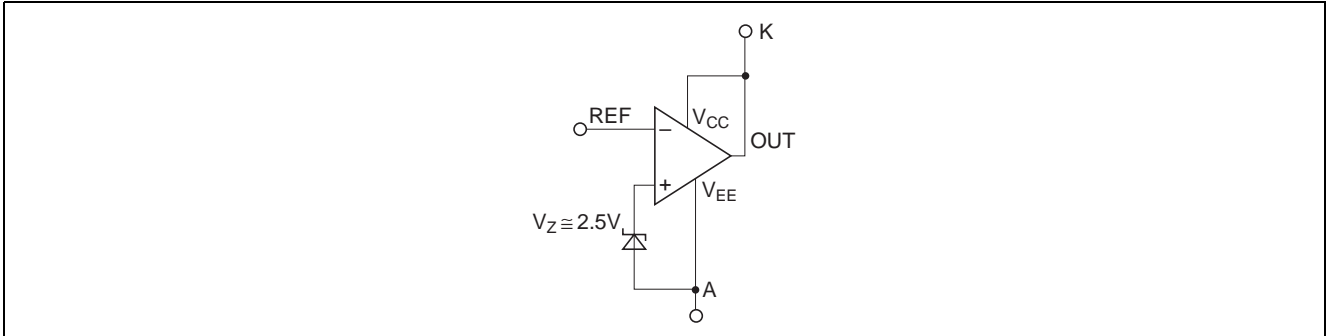
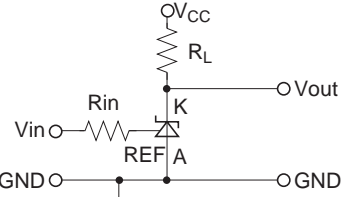
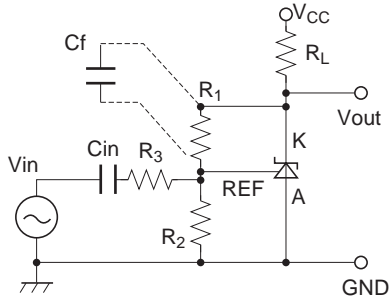
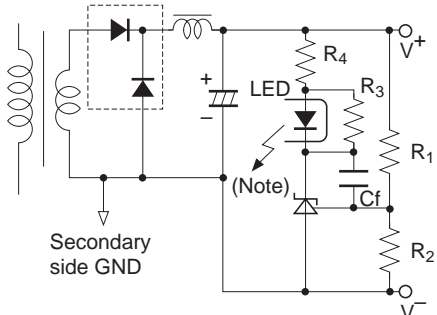

Figure 1 Operation Diagram

Application Hints

No.	Application Example	Description
1	<p>Reference voltage generation circuit</p>	<p>This is the simplest reference voltage circuit. The value of the resistance R is set so that cathode current $I_K \geq 1 \text{ mA}$. Output is fixed at $V_{out} \cong 2.5 \text{ V}$. The external capacitor C_L ($C_L \geq 3.3 \mu\text{F}$) is used to prevent oscillation in normal applications.</p>
2	<p>Variable output shunt regulator circuit</p>	<p>This is circuit 1 above with variable output provided. Here, $V_{out} \cong 2.5 \text{ V} \times \frac{(R_1 + R_2)}{R_2}$. Since the reference input current $I_{ref} = 3.8 \mu\text{A Typ}$ (V version: $I_{ref} = 2 \mu\text{A Typ}$) flows through R_1, resistance values are chosen to allow the resultant voltage drop to be ignored.</p>

Application Hints (cont.)

No.	Application Example	Description												
3	<p>Single power supply inverting comparator circuit</p> 	<p>This is an inverting type comparator with an input threshold voltage of approximately 2.5 V. Rin is the REF pin protection resistance, with a value of several kΩ to several tens of kΩ.</p> <p>RL is the load resistance, selected so that the cathode current $I_K \geq 1$ mA when Vout is low.</p> <table border="1" data-bbox="710 403 1197 492"> <thead> <tr> <th>Condition</th> <th>Vin</th> <th>Vout</th> <th>IC</th> </tr> </thead> <tbody> <tr> <td>C1</td> <td>Less than 2.5 V</td> <td>V_{CC} (V_{OH})</td> <td>OFF</td> </tr> <tr> <td>C2</td> <td>2.5 V or more</td> <td>Approx. 2 V (V_{OL})</td> <td>ON</td> </tr> </tbody> </table>	Condition	Vin	Vout	IC	C1	Less than 2.5 V	V _{CC} (V _{OH})	OFF	C2	2.5 V or more	Approx. 2 V (V _{OL})	ON
Condition	Vin	Vout	IC											
C1	Less than 2.5 V	V _{CC} (V _{OH})	OFF											
C2	2.5 V or more	Approx. 2 V (V _{OL})	ON											
4	<p>AC amplifier circuit</p>  <p>Gain $G = \frac{R_1}{R_2 // R_3}$ (DC gain)</p> <p>Cutoff frequency $f_c = \frac{1}{2\pi C_f (R_1 // R_2 // R_3)}$</p>	<p>This is an AC amplifier with voltage gain $G = -R_1 / (R_2 // R_3)$. The input is cut by capacitance Cin, so that the REF pin is driven by the AC input signal, centered on 2.5 V_{DC}.</p> <p>R2 also functions as a resistance that determines the DC cathode potential when there is no input, but if the input level is low and there is no risk of Vout clipping to V_{CC}, this can be omitted.</p> <p>To change the frequency characteristic, Cf should be connected as indicated by the dotted line.</p>												
5	<p>Switching power supply error amplification circuit</p>  <p>Note: LED : Light emitting diode in photocoupler R3 : Bypass resistor to feed IK (> Imin) when LED current vanishes R4 : LED protection resistance</p>	<p>This circuit performs control on the secondary side of a transformer, and is often used with a switching power supply that employs a photocoupler for offlining.</p> <p>The output voltage (between V+ and V-) is given by the following formula:</p> $V_{out} \cong 2.5 \text{ V} \times \frac{(R_1 + R_2)}{R_2}$ <p>In this circuit, the gain with respect to the Vout error is as follows:</p> $G = \frac{R_2}{(R_1 + R_2)} \times \left[\text{HA17431 open loop gain} \right] \times \left[\text{photocoupler total gain} \right]$ <p>As stated earlier, the HA17431 open-loop gain is 50 to 60 dB.</p>												

Application Hints (cont.)

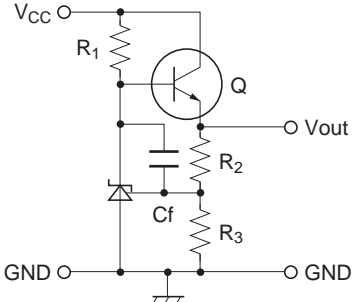
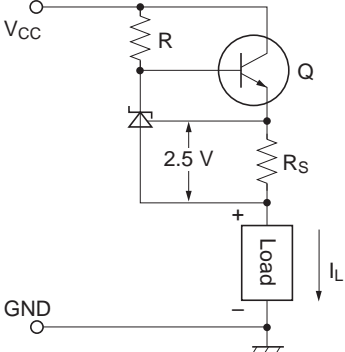
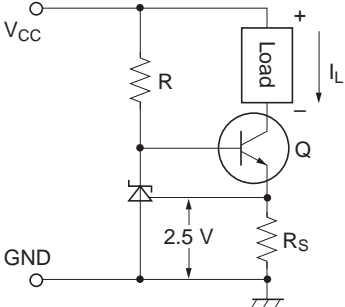
No.	Application Example	Description
6	<p>Constant voltage regulator circuit</p> 	<p>This is a 3-pin regulator with a discrete configuration, in which the output voltage</p> $V_{out} = 2.5 \text{ V} \times \frac{(R_2 + R_3)}{R_3}$ <p>R_1 is a bias resistance for supplying the HA17431 cathode current and the output transistor Q base current.</p>
7	<p>Discharge type constant current circuit</p> 	<p>This circuit supplies a constant current of</p> $I_L \cong \frac{2.5 \text{ V}}{R_S} \text{ [A]}$ <p>into the load. Caution is required since the HA17431 cathode current is also superimposed on I_L. The requirement in this circuit is that the cathode current must be greater than $I_{min} = 1 \text{ mA}$. The I_L setting therefore must be on the order of several mA or more.</p>
8	<p>Induction type constant current circuit</p> 	<p>In this circuit, the load is connected on the collector side of transistor Q in circuit 7 above. In this case, the load floats from GND, but the HA17431 cathode current is not superimposed on I_L, so that I_L can be kept small (1 mA or less is possible). The constant current value is the same as for circuit 7 above:</p> $I_L \cong \frac{2.5 \text{ V}}{R_S} \text{ [A]}$

Design Guide for AC-DC SMPS (Switching Mode Power Supply)

Use of Shunt Regulator in Transformer Secondary Side Control

This example is applicable to both forward transformers and flyback transformers. A shunt regulator is used on the secondary side as an error amplifier, and feedback to the primary side is provided via a photocoupler.

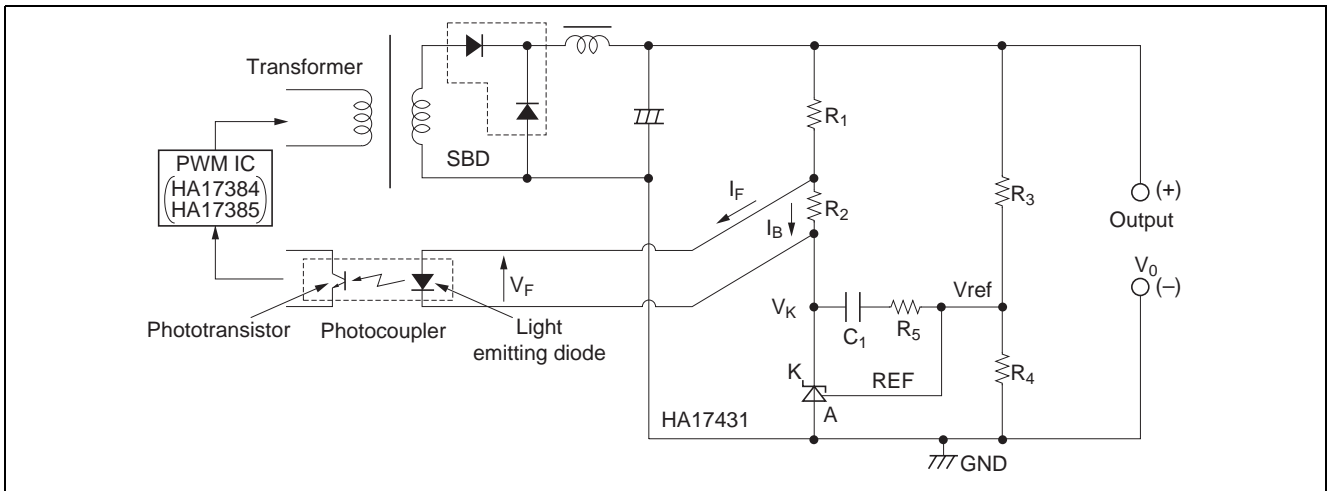

Figure 2 Typical Shunt Regulator/Error Amplifier

Determination of External Constants for the Shunt Regulator

DC characteristic determination: In figure 2, R_1 and R_2 are protection resistor for the light emitting diode in the photocoupler, and R_2 is a bypass resistor to feed I_K minimum, and these are determined as shown below. The photocoupler specification should be obtained separately from the manufacturer. Using the parameters in figure 2, the following formulas are obtained:

$$R_1 = \frac{V_0 - V_F - V_K}{I_F + I_B}, R_2 = \frac{V_F}{I_B}$$

V_K is the HA17431 operating voltage, and is set at around 3 V, taking into account a margin for fluctuation. R_2 is the current shunt resistance for the light emitting diode, in which a bias current I_B of around $1/5 I_F$ flows.

Next, the output voltage can be determined by R_3 and R_4 , and the following formula is obtained:

$$V_0 = \frac{R_3 + R_4}{R_4} \times V_{ref}, V_{ref} = 2.5 \text{ V Typ}$$

The absolute values of R_3 and R_4 are determined by the HA17431 reference input current I_{ref} and the AC characteristics described in the next section. The I_{ref} value is around $3.8 \mu\text{A Typ}$. (V version: $2 \mu\text{A Typ}$)

AC characteristic determination: This refers to the determination of the gain frequency characteristic of the shunt regulator as an error amplifier. Taking the configuration in figure 2, the error amplifier characteristic is as shown in figure 3.

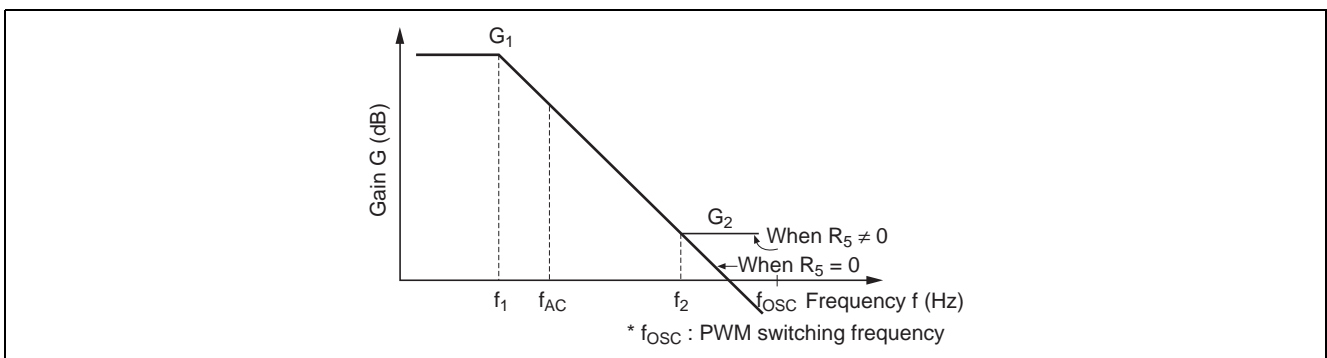

Figure 3 HA17431 Error Amplification Characteristic

In Figure 3, the following formulas are obtained:

Gain

$$G_1 = G_0 \approx 50 \text{ dB to } 60 \text{ dB (determined by shunt regulator)}$$

$$G_2 = \frac{R_5}{R_3}$$

Corner frequencies

$$f_1 = 1/(2\pi C_1 G_0 R_3)$$

$$f_2 = 1/(2\pi C_1 R_5)$$

G_0 is the shunt regulator open-loop gain; this is given by the reciprocal of the reference voltage fluctuation $\Delta V_{\text{ref}}/\Delta V_{K_A}$, and is approximately 50 dB.

Practical Example

Consider the example of a photocoupler, with an internal light emitting diode $V_F = 1.05 \text{ V}$ and $I_F = 2.5 \text{ mA}$, power supply output voltage $V_2 = 5 \text{ V}$, and bias resistance R_2 current of approximately $1/5 I_F$ at 0.5 mA . If the shunt regulator $V_K = 3 \text{ V}$, the following values are found.

$$R_1 = \frac{5V - 1.05V - 3V}{2.5\text{mA} + 0.5\text{mA}} = 316(\Omega) \text{ (330}\Omega \text{ from E24 series)}$$

$$R_2 = \frac{1.05V}{0.5\text{mA}} = 2.1(\text{k}\Omega) \text{ (2.2k}\Omega \text{ from E24 series)}$$

Next, assume that $R_3 = R_4 = 10 \text{ k}\Omega$. This gives a 5 V output. If $R_5 = 3.3 \text{ k}\Omega$ and $C_1 = 0.022 \mu\text{F}$, the following values are found.

$$G_2 = 3.3 \text{ k}\Omega / 10 \text{ k}\Omega = 0.33 \text{ times } (-10 \text{ dB})$$

$$f_1 = 1 / (2 \times \pi \times 0.022 \mu\text{F} \times 316 \times 10 \text{ k}\Omega) = 2.3 \text{ (Hz)}$$

$$f_2 = 1 / (2 \times \pi \times 0.022 \mu\text{F} \times 3.3 \text{ k}\Omega) = 2.2 \text{ (kHz)}$$

Package Dimensions

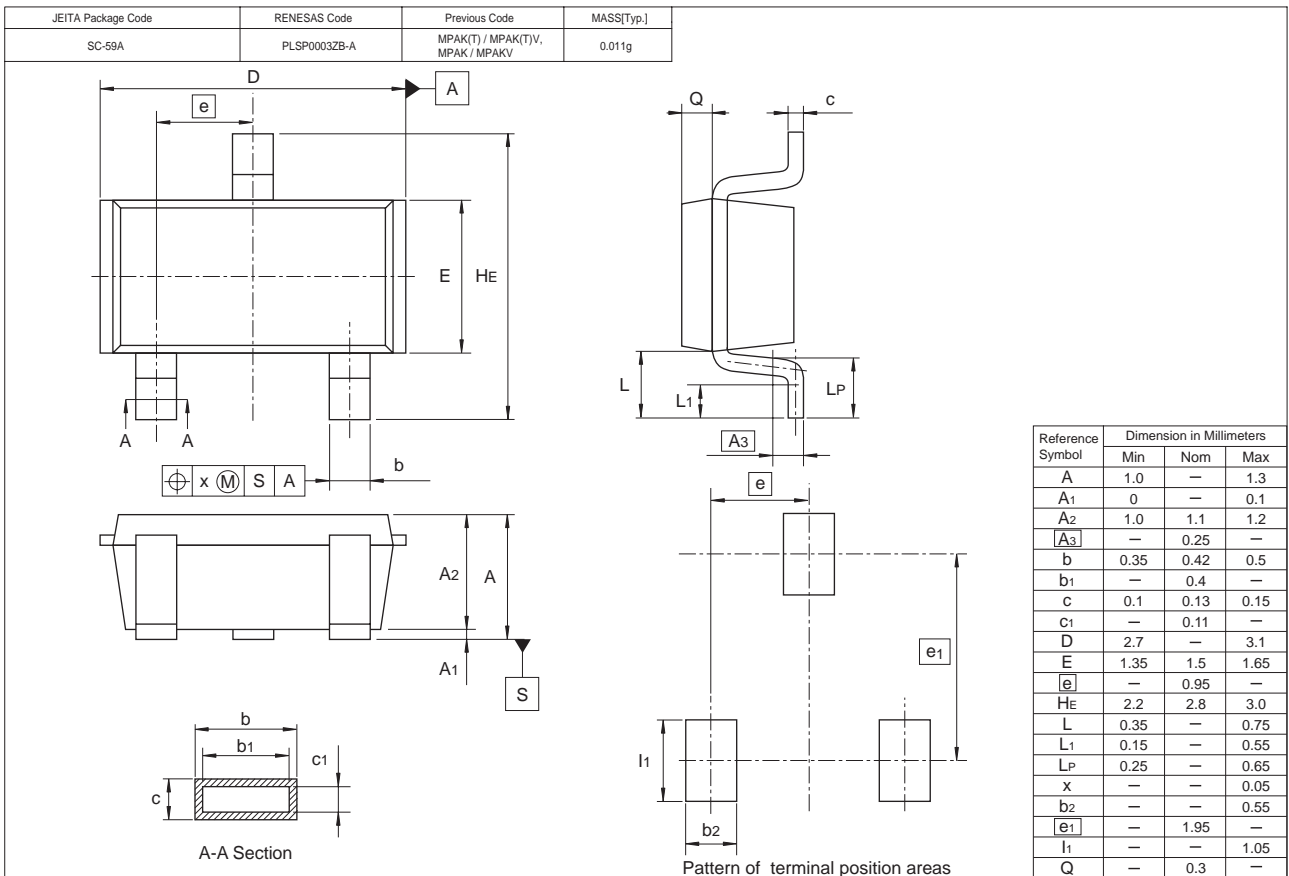
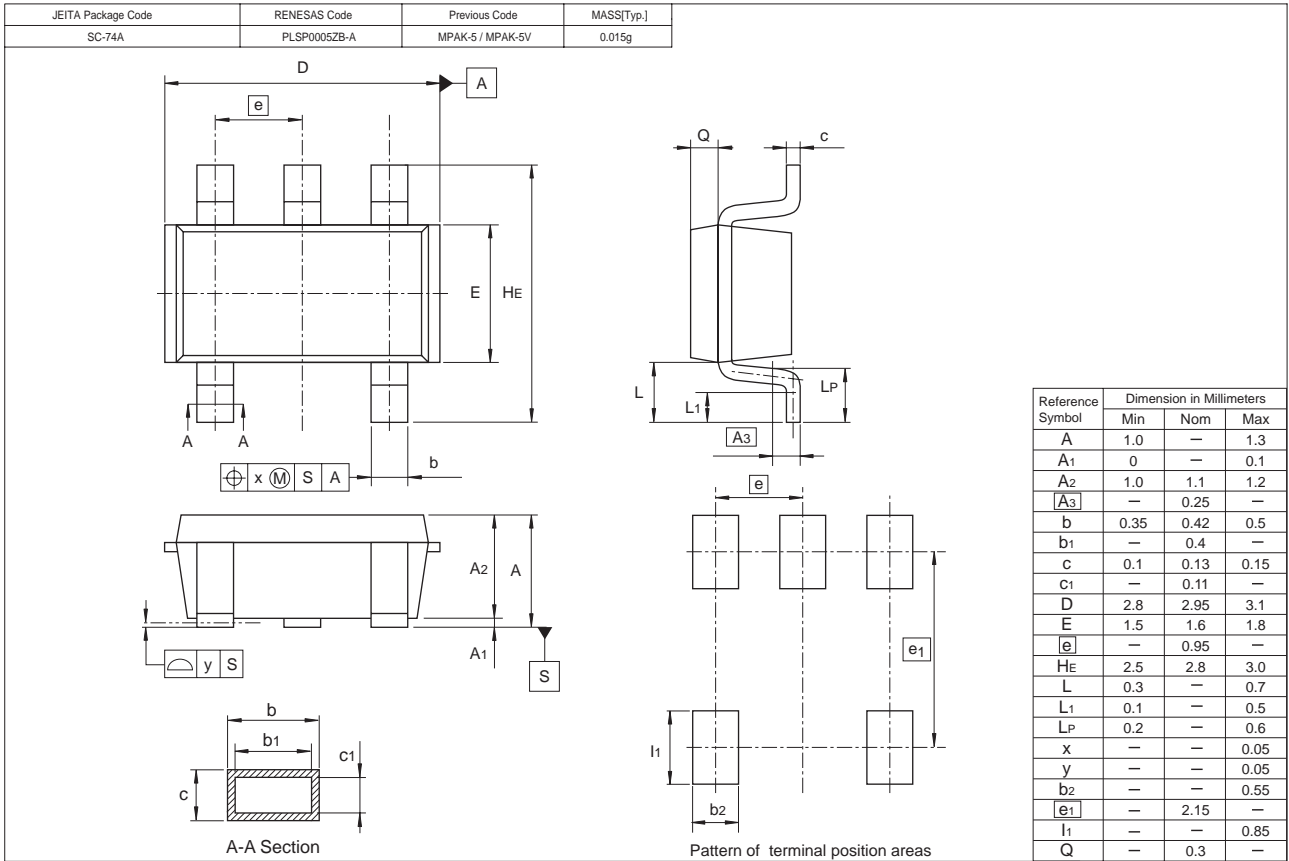

HA17431 Series

JEITA Package Code	RENESAS Code	Previous Code	MASS[Typ.]
SC-62	PLZZ0004CA-A	UPAK / UPAKV	0.050g

Unit: mm

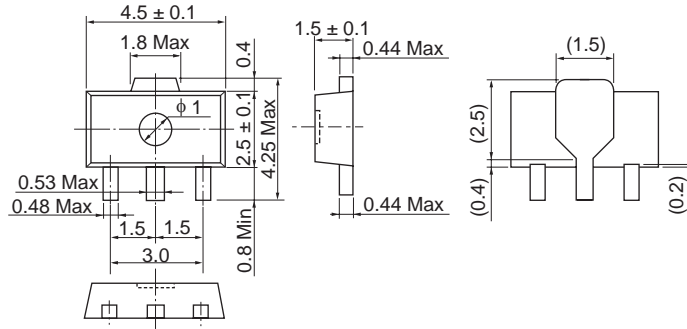

JEITA Package Code	RENESAS Code	Previous Code	MASS[Typ.]
P-SOP8-4.4x4.85-1.27	PRSP0008DE-B	FP-8DGV	0.1g

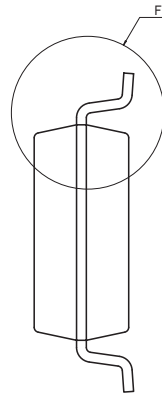
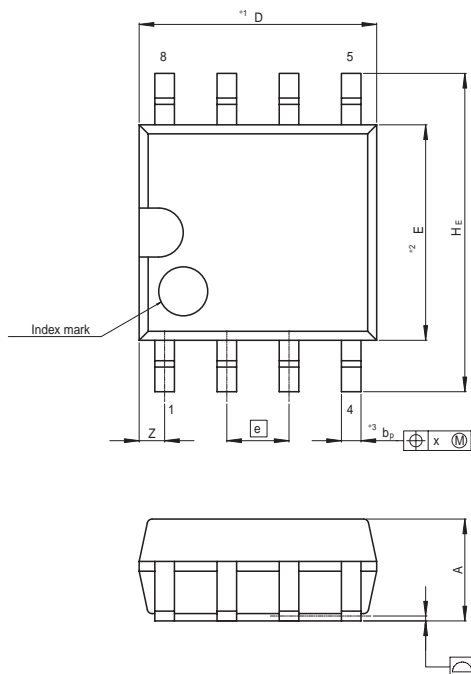

NOTE)
 1. DIMENSIONS**1 (Nom)**AND**2*
 DO NOT INCLUDE MOLD FLASH.
 2. DIMENSION**3*DOES NOT
 INCLUDE TRIM OFFSET.

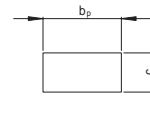

Terminal cross section
(Ni/Pd/Au plating)

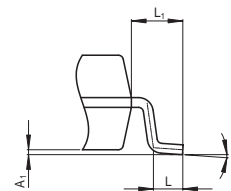

Detail F

Reference Symbol	Dimension in Millimeters		
	Min	Nom	Max
D	—	4.85	5.25
E	—	4.4	—
A ₂	—	—	—
A ₁	0.00	0.1	0.20
A	—	—	2.03
b _p	0.35	0.4	0.45
b ₁	—	—	—
c	0.15	0.20	0.25
c ₁	—	—	—
θ	0°	—	8°
H _E	6.35	6.5	6.75
e	—	1.27	—
x	—	—	0.12
y	—	—	0.15
Z	—	—	0.75
L	0.42	0.60	0.85
L ₁	—	1.05	—

HA17431 Series

JEITA Package Code	RENESAS Code	Previous Code	MASS[Typ.]
SC-43A	PRSS0003DA-A	TO-92(1) / TO-92(1)V	0.25g

Unit: mm

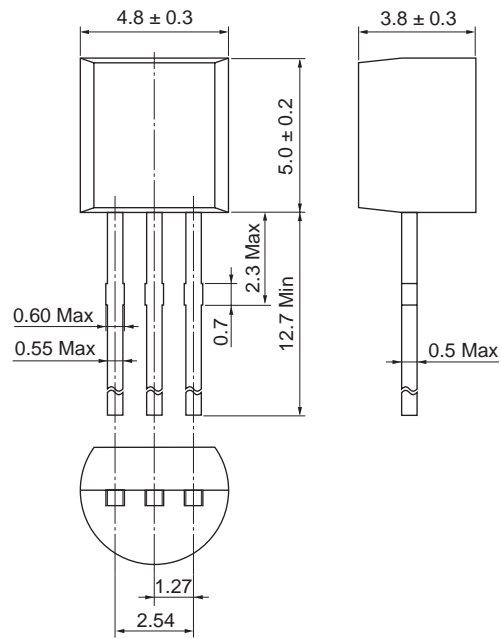

JEITA Package Code	RENESAS Code	Previous Code	MASS[Typ.]
SC-51	PRSS0003DC-A	TO-92 Mod / TO-92 ModV	0.35g

Unit: mm

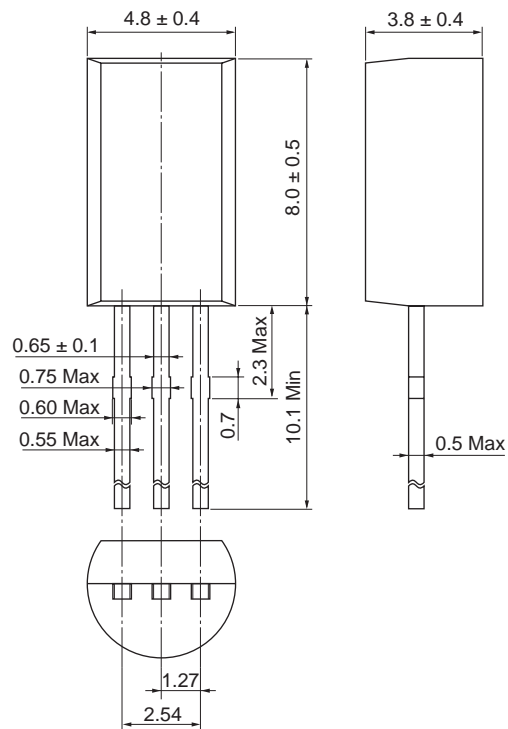

Renesas Technology Corp. Sales Strategic Planning Div. Nippon Bldg., 2-6-2, Ohte-machi, Chiyoda-ku, Tokyo 100-0004, Japan

Keep safety first in your circuit designs!

1. Renesas Technology Corp. puts the maximum effort into making semiconductor products better and more reliable, but there is always the possibility that trouble may occur with them. Trouble with semiconductors may lead to personal injury, fire or property damage.
Remember to give due consideration to safety when making your circuit designs, with appropriate measures such as (i) placement of substitutive, auxiliary circuits, (ii) use of nonflammable material or (iii) prevention against any malfunction or mishap.

Notes regarding these materials

1. These materials are intended as a reference to assist our customers in the selection of the Renesas Technology Corp. product best suited to the customer's application; they do not convey any license under any intellectual property rights, or any other rights, belonging to Renesas Technology Corp. or a third party.
 2. Renesas Technology Corp. assumes no responsibility for any damage, or infringement of any third-party's rights, originating in the use of any product data, diagrams, charts, programs, algorithms, or circuit application examples contained in these materials.
 3. All information contained in these materials, including product data, diagrams, charts, programs and algorithms represents information on products at the time of publication of these materials, and are subject to change by Renesas Technology Corp. without notice due to product improvements or other reasons. It is therefore recommended that customers contact Renesas Technology Corp. or an authorized Renesas Technology Corp. product distributor for the latest product information before purchasing a product listed herein.
The information described here may contain technical inaccuracies or typographical errors.
Renesas Technology Corp. assumes no responsibility for any damage, liability, or other loss rising from these inaccuracies or errors.
Please also pay attention to information published by Renesas Technology Corp. by various means, including the Renesas Technology Corp. Semiconductor home page (<http://www.renesas.com>).
 4. When using any or all of the information contained in these materials, including product data, diagrams, charts, programs, and algorithms, please be sure to evaluate all information as a total system before making a final decision on the applicability of the information and products. Renesas Technology Corp. assumes no responsibility for any damage, liability or other loss resulting from the information contained herein.
 5. Renesas Technology Corp. semiconductors are not designed or manufactured for use in a device or system that is used under circumstances in which human life is potentially at stake. Please contact Renesas Technology Corp. or an authorized Renesas Technology Corp. product distributor when considering the use of a product contained herein for any specific purposes, such as apparatus or systems for transportation, vehicular, medical, aerospace, nuclear, or undersea repeater use.
 6. The prior written approval of Renesas Technology Corp. is necessary to reprint or reproduce in whole or in part these materials.
 7. If these products or technologies are subject to the Japanese export control restrictions, they must be exported under a license from the Japanese government and cannot be imported into a country other than the approved destination.
Any diversion or reexport contrary to the export control laws and regulations of Japan and/or the country of destination is prohibited.
 8. Please contact Renesas Technology Corp. for further details on these materials or the products contained therein.
-



RENESAS SALES OFFICES

<http://www.renesas.com>

Refer to "<http://www.renesas.com/en/network>" for the latest and detailed information.

Renesas Technology America, Inc.

450 Holger Way, San Jose, CA 95134-1368, U.S.A
Tel: <1> (408) 382-7500, Fax: <1> (408) 382-7501

Renesas Technology Europe Limited

Dukes Meadow, Millboard Road, Bourne End, Buckinghamshire, SL8 5FH, U.K.
Tel: <44> (1628) 585-100, Fax: <44> (1628) 585-900

Renesas Technology Hong Kong Ltd.

7th Floor, North Tower, World Finance Centre, Harbour City, 1 Canton Road, Tsimshatsui, Kowloon, Hong Kong
Tel: <852> 2265-6688, Fax: <852> 2730-6071

Renesas Technology Taiwan Co., Ltd.

10th Floor, No.99, Fushing North Road, Taipei, Taiwan
Tel: <886> (2) 2715-2888, Fax: <886> (2) 2713-2999

Renesas Technology (Shanghai) Co., Ltd.

Unit2607 Ruijing Building, No.205 Maoming Road (S), Shanghai 200020, China
Tel: <86> (21) 6472-1001, Fax: <86> (21) 6415-2952

Renesas Technology Singapore Pte. Ltd.

1 Harbour Front Avenue, #06-10, Keppel Bay Tower, Singapore 098632
Tel: <65> 6213-0200, Fax: <65> 6278-8001