



Features

- This series is UL listed under the Recognized Component Index, file number E142814
- Ideal for printed circuit board mounting
- The plastic material used carries Underwriters Laboratory flammability recognition 94V-0
- Built-in printed circuit board stand-offs
- High case dielectric strength
- High temperature soldering guaranteed 265°C /10 seconds at 5 lbs (2.3kg) tension



KBP

Package Marking and Ordering Information

Product ID	Pack	Marking	Qty(PCS)
KBP307	KBP	KBP307	500

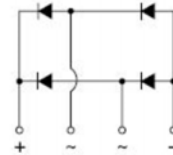

Maxmim Ratings (Ta=25 unless otherwise noted)

Parameter	Symbol	KBP307	Unit
Maximum repetitive peak reverse voltage	VRRM	800	V
Maximum RMS bridge input voltage	VRMS	560	V
Maximum DC blocking voltage	VDC	800	V
Maximum average forward rectified output current at TA=50°C	IF(AV)	3.0	A
Peak forward surge current single sine-wave superimposed on rated load (JEDEC Method)	IFSM	80	A
Rating for fusing (t<8.3ms)	I ² t	15.0	A ² sec
Typical thermal resistance per element (1)	ReJA	10.0	°C/W
Typical junction capacitance per element (2)	Cj	25.0	pF
Operating junction and storage temperature range	TJ, TSTG	-55 to + 150	°C

Electrical Characteristics

Rating at 25°C ambient temperature unless otherwise specified. Resistive or Inductive load, 60Hz.
For Capacitive load derate by 20 %.

Parameter	Symbol	KBP307	Unit
Maximum instantaneous forward voltage drop per leg at 3.0A	V _F	1.1	V
Maximum DC reverse current at rated TA =25°C DC blocking voltage per element TA =125°C	I _R	10 500	μA

Notes: (1)Thermal resistance from Junction to Ambient on P.C.board mounting.
(2)Measured at 3.0MHz and applied reverse voltage of 4.0 volts.



Rating and Characteristic Curves (TA=25°C Unless otherwise noted)

Fig. 1 Derating Curve for Output Rectified Current

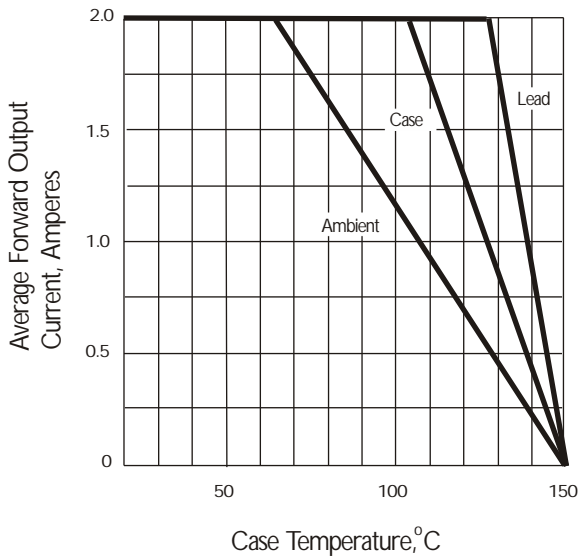

Fig. 2 Maximum Non-repetitive Peak Forward Surge Current

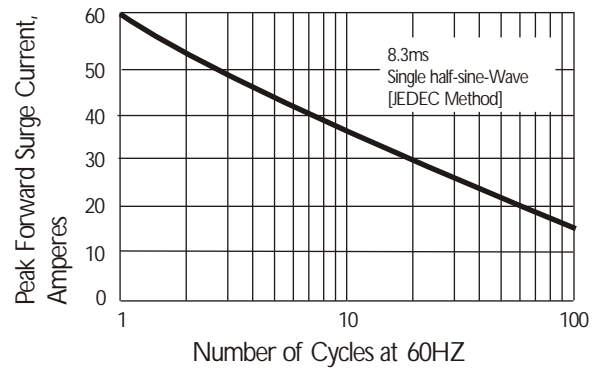

Fig. 3 Typical Instantaneous Forward Characteristics

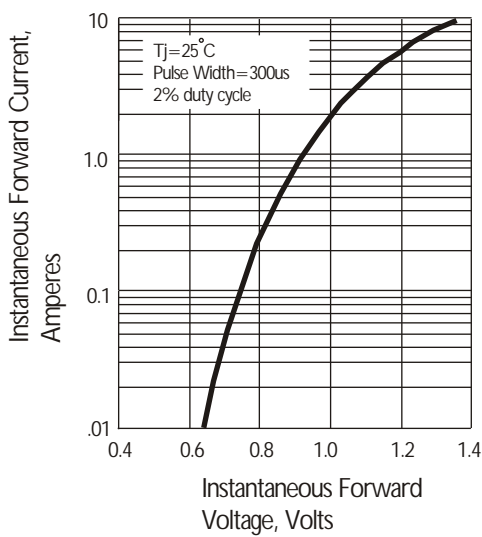

Fig. 4 Typical Reverse Characteristics

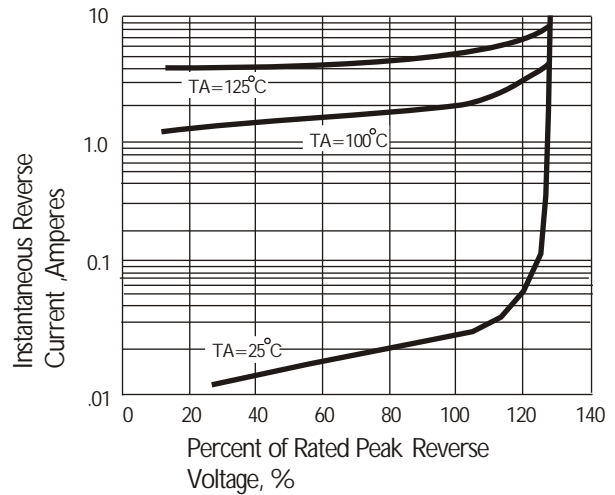
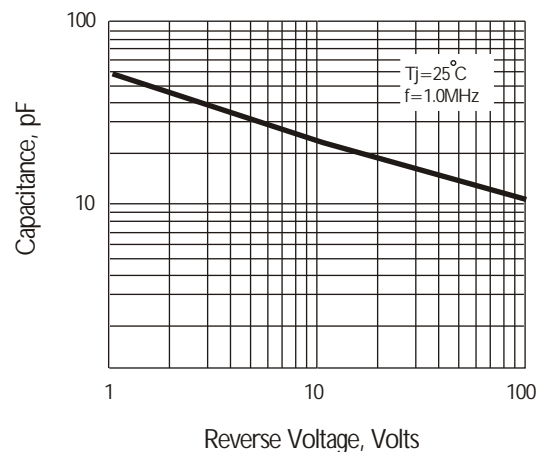

Fig. 5 Typical Junction Capacitance





Package Outline Dimensions

KBP

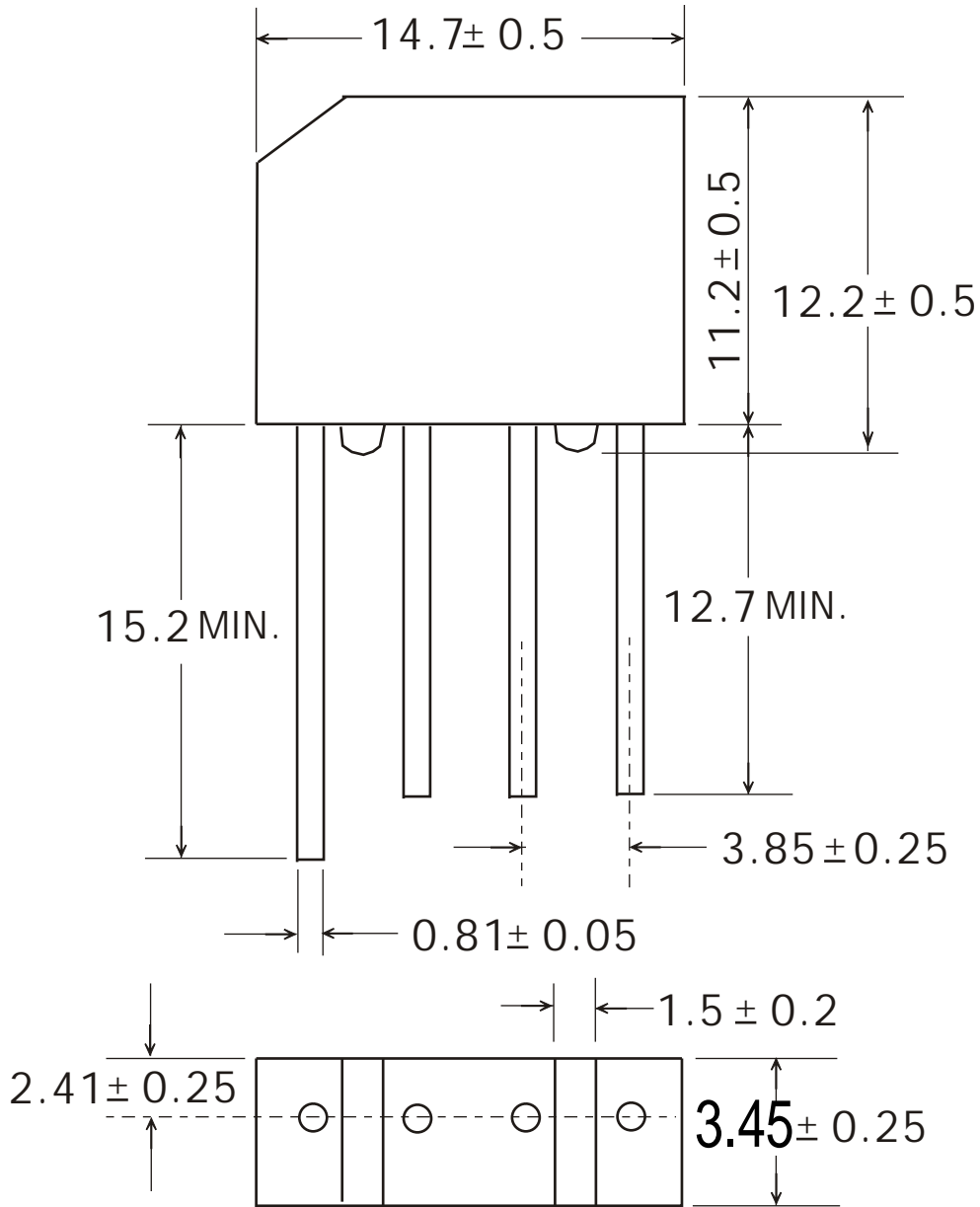

Dimensions in millimeters(1mm =0.0394")



Attention

- Any and all HUA XUAN YANG ELECTRONICS products described or contained herein do not have specifications that can handle applications that require extremely high levels of reliability, such as life-support systems, aircraft's control systems, or other applications whose failure can be reasonably expected to result in serious physical and/or material damage. Consult with your HUA XUAN YANG ELECTRONICS representative nearest you before using any HUA XUAN YANG ELECTRONICS products described or contained herein in such applications.
- HUA XUAN YANG ELECTRONICS assumes no responsibility for equipment failures that result from using products at values that exceed, even momentarily, rated values (such as maximum ratings, operating condition ranges, or other parameters) listed in products specifications of any and all HUA XUAN YANG ELECTRONICS products described or contained herein.
- Specifications of any and all HUA XUAN YANG ELECTRONICS products described or contained herein stipulate the performance, characteristics, and functions of the described products in the independent state, and are not guarantees of the performance, characteristics, and functions of the described products as mounted in the customer's products or equipment. To verify symptoms and states that cannot be evaluated in an independent device, the customer should always evaluate and test devices mounted in the customer's products or equipment.
- HUA XUAN YANG ELECTRONICS CO.,LTD. strives to supply high-quality high-reliability products. However, any and all semiconductor products fail with some probability. It is possible that these probabilistic failures could give rise to accidents or events that could endanger human lives, that could give rise to smoke or fire, or that could cause damage to other property. When designing equipment, adopt safety measures so that these kinds of accidents or events cannot occur. Such measures include but are not limited to protective circuits and error prevention circuits for safe design, redundant design, and structural design.
- In the event that any or all HUA XUAN YANG ELECTRONICS products(including technical data, services) described or contained herein are controlled under any of applicable local export control laws and regulations, such products must not be exported without obtaining the export license from the authorities concerned in accordance with the above law.
- No part of this publication may be reproduced or transmitted in any form or by any means, electronic or mechanical, including photocopying and recording, or any information storage or retrieval system, or otherwise, without the prior written permission of HUA XUAN YANG ELECTRONICS CO.,LTD.
- Information (including circuit diagrams and circuit parameters) herein is for example only ; it is not guaranteed for volume production. HUA XUAN YANG ELECTRONICS believes information herein is accurate and reliable, but no guarantees are made or implied regarding its use or any infringements of intellectual property rights or other rights of third parties.
- Any and all information described or contained herein are subject to change without notice due to product/technology improvement, etc. When designing equipment, refer to the "Delivery Specification" for the HUA XUAN YANG ELECTRONICS product that you intend to use.