

GENERAL DESCRIPTION

The SGM41566 is designed for charging low capacity battery cell with factory-programmable current programmable in the range of 50mA to 750mA from loosen regulated power source. The device features low drop-out constant-current constant-voltage charging, weak battery pre-charging, voltage fold-back safe retaining, floating charging protection and system start-up pre-charge, with NTC sensing protection.

The SGM41566 is available in a Green TDFN-2×2-8AL package. It operates in -40°C to +125°C junction temperature.

FEATURES

- Loosen Regulated Power Input
- Battery Voltages Option:
 - 25mV Raster in 3.5V to 4.8V Range
- Charging Current Option:
 - 50mA Raster in 50mA to 750mA Range
- 5% to 25% Residual End-of-Charge Option
- Weak Battery Pre-Charge Option
- Voltage Fold-Back Safe Power Retaining
- NTC Temperature Sensing for Protection
- Floating Charging Protection
- Start-Up Charging for 12.5ms
- 650ms Power Recycle Certification
- Full Charging Power-Up at Low Voltage
- Pre-Charging Power-Up at Normal Voltage
- Available in a Green TDFN-2×2-8AL Package

APPLICATIONS

Low Capacity Rechargeable Battery Powered Applications

TYPICAL APPLICATION

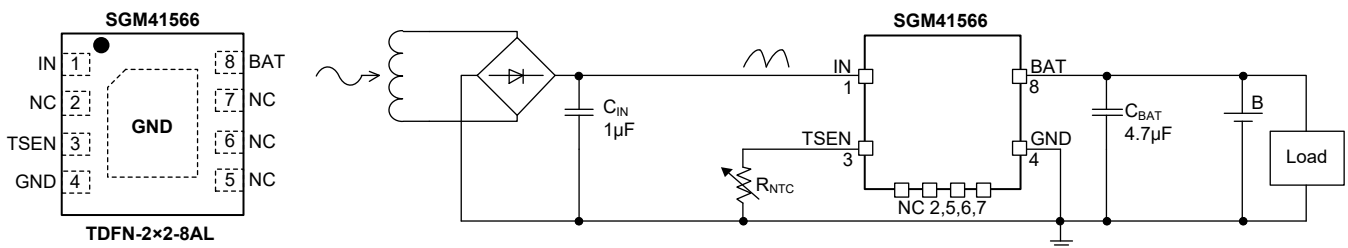

Figure 1. Typical Application Circuit

PACKAGE/ORDERING INFORMATION

MODEL	PACKAGE DESCRIPTION	SPECIFIED TEMPERATURE RANGE	ORDERING NUMBER	PACKAGE MARKING	PACKING OPTION
SGM41566-350C55	TDFN-2x2-8AL	-40°C to +125°C	SGM41566-350C55XTDE8G/TR	MDV XXXX	Tape and Reel, 3000
SGM41566-360F41	TDFN-2x2-8AL	-40°C to +125°C	SGM41566-360F41XTDE8G/TR	MDR XXXX	Tape and Reel, 3000
SGM41566-360N21	TDFN-2x2-8AL	-40°C to +125°C	SGM41566-360N21XTDE8G/TR	07B XXXX	Tape and Reel, 3000
SGM41566-365A33	TDFN-2x2-8AL	-40°C to +125°C	SGM41566-365A33XTDE8G/TR	074 XXXX	Tape and Reel, 3000
SGM41566-365A41	TDFN-2x2-8AL	-40°C to +125°C	SGM41566-365A41XTDE8G/TR	MDU XXXX	Tape and Reel, 3000
SGM41566-365O12	TDFN-2x2-8AL	-40°C to +125°C	SGM41566-365O12XTDE8G/TR	MDW XXXX	Tape and Reel, 3000
SGM41566-365O22	TDFN-2x2-8AL	-40°C to +125°C	SGM41566-365O22XTDE8G/TR	MDM XXXX	Tape and Reel, 3000
SGM41566-405A14	TDFN-2x2-8AL	-40°C to +125°C	SGM41566-405A14XTDE8G/TR	MDT XXXX	Tape and Reel, 3000
SGM41566-405A22	TDFN-2x2-8AL	-40°C to +125°C	SGM41566-405A22XTDE8G/TR	04Z XXXX	Tape and Reel, 3000
SGM41566-405A33	TDFN-2x2-8AL	-40°C to +125°C	SGM41566-405A33XTDE8G/TR	051 XXXX	Tape and Reel, 3000
SGM41566-405A55	TDFN-2x2-8AL	-40°C to +125°C	SGM41566-405A55XTDE8G/TR	054 XXXX	Tape and Reel, 3000
SGM41566-405D11	TDFN-2x2-8AL	-40°C to +125°C	SGM41566-405D11XTDE8G/TR	04Y XXXX	Tape and Reel, 3000
SGM41566-405D22	TDFN-2x2-8AL	-40°C to +125°C	SGM41566-405D22XTDE8G/TR	050 XXXX	Tape and Reel, 3000
SGM41566-405D33	TDFN-2x2-8AL	-40°C to +125°C	SGM41566-405D33XTDE8G/TR	052 XXXX	Tape and Reel, 3000
SGM41566-405D44	TDFN-2x2-8AL	-40°C to +125°C	SGM41566-405D44XTDE8G/TR	053 XXXX	Tape and Reel, 3000
SGM41566-405L21	TDFN-2x2-8AL	-40°C to +125°C	SGM41566-405L21XTDE8G/TR	MDY XXXX	Tape and Reel, 3000
SGM41566-405N21	TDFN-2x2-8AL	-40°C to +125°C	SGM41566-405N21XTDE8G/TR	01Z XXXX	Tape and Reel, 3000
SGM41566-415J11	TDFN-2x2-8AL	-40°C to +125°C	SGM41566-415J11XTDE8G/TR	075 XXXX	Tape and Reel, 3000
SGM41566-415L21	TDFN-2x2-8AL	-40°C to +125°C	SGM41566-415L21XTDE8G/TR	MDX XXXX	Tape and Reel, 3000
SGM41566-420B04	TDFN-2x2-8AL	-40°C to +125°C	SGM41566-420B04XTDE8G/TR	076 XXXX	Tape and Reel, 3000
SGM41566-420J04	TDFN-2x2-8AL	-40°C to +125°C	SGM41566-420J04XTDE8G/TR	MDZ XXXX	Tape and Reel, 3000
SGM41566-420O22	TDFN-2x2-8AL	-40°C to +125°C	SGM41566-420O22XTDE8G/TR	077 XXXX	Tape and Reel, 3000
SGM41566-435C33	TDFN-2x2-8AL	-40°C to +125°C	SGM41566-435C33XTDE8G/TR	078 XXXX	Tape and Reel, 3000

MODEL	PACKAGE DESCRIPTION	SPECIFIED TEMPERATURE RANGE	ORDERING NUMBER	PACKAGE MARKING	PACKING OPTION
SGM41566-440D11	TDFN-2x2-8AL	-40°C to +125°C	SGM41566-440D11XTDE8G/TR	MDQ XXXX	Tape and Reel, 3000
SGM41566-440O22	TDFN-2x2-8AL	-40°C to +125°C	SGM41566-440O22XTDE8G/TR	079 XXXX	Tape and Reel, 3000

NOTE: Contact Factory if other charge voltage and/or charge current are desired.

MARKING INFORMATION

NOTE: XXXX = Date Code, Trace Code and Vendor Code.

YYY — Serial Number

XXXX

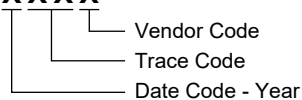

Green (RoHS & HSF): SG Micro Corp defines "Green" to mean Pb-Free (RoHS compatible) and free of halogen substances. If you have additional comments or questions, please contact your SGMICRO representative directly.

ABSOLUTE MAXIMUM RATINGS

IN to GND	-0.3V to 28V
IN Clamp Current or Voltage ⁽¹⁾	10mA or 28V
BAT to GND (When $V_{IN} > V_{BAT}$)	-0.3V to 20V
BAT to GND (When $V_{IN} \leq V_{BAT}$)	-0.3V to 4.8V
TSEN to GND	-0.3V to 6V
TSEN Clamp Current or Voltage ⁽¹⁾	0.3mA or 6V
Package Thermal Resistance	
TDFN-2x2-8AL, θ_{JA}	95°C/W
TDFN-2x2-8AL, θ_{JB}	47°C/W
TDFN-2x2-8AL, $\theta_{JC(TOP)}$	84°C/W
TDFN-2x2-8AL, $\theta_{JC(BOT)}$	9°C/W
Junction Temperature	+150°C
Storage Temperature Range	-65°C to +150°C
Lead Temperature (Soldering, 10s)	+260°C
ESD Susceptibility	
HBM	8000V
CDM	1000V

RECOMMENDED OPERATING CONDITIONS

Supply Voltage Range	2.9V to 19.5V
IN Clamp Current or Voltage ⁽¹⁾	10mA or 19.5V
TSEN Clamp Current or Voltage ⁽¹⁾	0.3mA or 5.5V
Input Effective Capacitance, C_{IN}	0.1 μ F to 12 μ F
Output Effective Capacitance, C_{BAT}	1 μ F to 12 μ F
Operating Junction Temperature Range	-40°C to +125°C

NOTE:

1. The current limit and voltage limit are set for those values which applies onto the IN or TSEN pin current and voltage source for 10 minutes and should not cause any change to key operation parameters.

OVERSTRESS CAUTION

Stresses beyond those listed in Absolute Maximum Ratings may cause permanent damage to the device. Exposure to absolute maximum rating conditions for extended periods may affect reliability. Functional operation of the device at any conditions beyond those indicated in the Recommended Operating Conditions section is not implied.

ESD SENSITIVITY CAUTION

This integrated circuit can be damaged if ESD protections are not considered carefully. SGMICRO recommends that all integrated circuits be handled with appropriate precautions. Failure to observe proper handling and installation procedures can cause damage. ESD damage can range from subtle performance degradation to complete device failure. Precision integrated circuits may be more susceptible to damage because even small parametric changes could cause the device not to meet the published specifications.

DISCLAIMER

SG Micro Corp reserves the right to make any change in circuit design, or specifications without prior notice.

SUFFIX CODE FOR CHARGE VOLTAGE AND CHARGE CURRENT

Surfix: **vvvZmn**

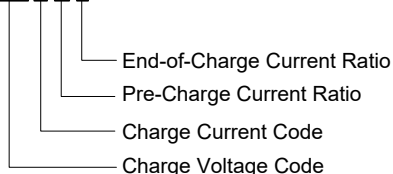

Model: SGM41566- vvvZmn							
Charge Voltage (Option Code "vvv")				Charge Current (Option Code "Z")		Pre-Charge Ratio (to Charge Current) (Option Code "m")	
Code	Voltage (V)	Code	Voltage (V)	Code	Current (mA)	Code	Current Ratio (%)
350	3.500	438	4.375	A	50	0	No pre-charge
355	3.550	440	4.400	B	100	1	5
360	3.600	443	4.425	C	150	2	10
365	3.650	445	4.450	D	200	3	15
370	3.700	448	4.475	E	250	4	20
375	3.750	450	4.500	F	300	5	25
380	3.800	453	4.525	G	350	End-of-Charge Ratio (to Charge Current) (Option Code "n")	
385	3.850	455	4.550	H	400		
390	3.900	458	4.575	I	450		
395	3.950	460	4.600	J	500	Code	Current Ratio (%)
400	4.000	463	4.625	K	550	1	5
405	4.050	465	4.650	L	600	2	10
410	4.100	468	4.675	M	650	3	15
415	4.150	470	4.700	N	700	4	20
420	4.200	473	4.725	O	750	5	25
425	4.250	475	4.750				
430	4.300	478	4.775				
433	4.325	480	4.800				
435	4.350						

PIN CONFIGURATION

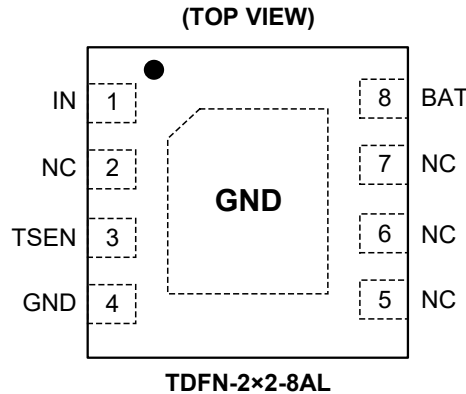

PIN DESCRIPTION

PIN	NAME	TYPE ⁽¹⁾	FUNCTION
1	IN	P	Charge Power Input, for Powering this Device and Feeding to the Charge Output. The capacitor with effective capacitance in the range of 0.1μF to 12μF is recommended. It should be placed close to this pin for decoupling.
3	TSEN	IO	Temperature Sensing and Enable Input. The external connection to this pin is checked, once power input voltage is in the effective range by feeding current (38.6μA) out of the pin. If the pin voltage is less than V _{ENL} (102mV), it is considered as being grounded. The charging function is disabled while the feeding current is reduced to about 25.5μA. If the pin voltage is higher than V _{ENH} (2.68V), charging function is enabled. If the pin voltage is between V _{ENL} and V _{ENH} , it is considered that the NTC thermistor is connected, and the ground resistance is evaluated for temperature safe charging. In this case, charging is allowed, only when the pin voltage is within the range of hot threshold resistance related voltage V _{HOT} to cold threshold related voltage V _{COLD} . The feeding current biases the pin voltage to be higher than V _{COLD} but less than V _{ENH} . If pin voltage in this range is found, it is considered to be excessive cold condition or NTC connection open, charge function is disabled.
4	GND	G	Ground of the Circuit.
8	BAT	O	Output to the Battery and/or System Load for Charging and/or Powering the System Load. The output decoupling capacitor with effective capacitance in the range of 1μF to 12μF is recommended. The pin sinks about 4μA if the pin voltage is higher than charging voltage, and the pin sinks about 1.5mA if output clamp is triggered.
2, 5, 6, 7	NC	NC	No Internal Connection.
Exposed Pad	GND	—	Exposed Pad. Exposed pad is internally connected to GND. Connect it to a large ground plane to maximize thermal dissipation.

NOTE:

1. P = Power, IO = Input and Output, G = Ground, O = Output, NC = No Connection.

ELECTRICAL CHARACTERISTICS

($V_{IN} = (V_{CHG(NOM)} + 0.5V)$ or 5V (whichever is greater), $V_{TSEN} = 0.4V$, $T_J = -40^\circ C$ to $+125^\circ C$, typical values are at $T_J = +25^\circ C$, unless otherwise noted.)

PARAMETER	SYMBOL	CONDITIONS	MIN	TYP	MAX	UNITS	
Input Voltage Range	V_{IN}		2.9		19.5	V	
Charge Voltage Range	V_{CHG}	V_{CHG} option range	3.5		4.8	V	
Charge Current Range	I_{CHG}	I_{CHG} option range	50		750	mA	
Input Clamp Voltage	V_{OV}	$I_{IN} = 10mA$	20	21	22	V	
Input Clamp Current	I_{OV}	$V_{IN} = 22V$	18	26	33	mA	
Pass On-Resistance	R_{ON}	$I_{IN} = 90\% \times I_{CHG}$, $V_{BAT} = 3V$, $I_{CHG} \geq 200mA$		0.6	1.1	Ω	
BAT Leakage	$I_{STANDBY}$	$V_{BAT} = 95\% \times V_{CHG}$, IN floating, $T_J = -40^\circ C$ to $+85^\circ C$		1	3	μA	
		$V_{BAT} = 95\% \times V_{CHG}$, $V_{TSEN} = 0V$, $T_J = -40^\circ C$ to $+85^\circ C$		1	8		
		$V_{BAT} = 95\% \times V_{CHG}$, TSEN floating, $T_J = -40^\circ C$ to $+85^\circ C$		2.4	8		
Input Current	I_Q	$V_{TSEN} = 0V$, charging disabled		66	95	μA	
		$V_{TSEN} = 5V$, charging terminated		80	125		
		$V_{TSEN} = 0.4V$, charging terminated		125	180		
In-Charging Current	I_{GND}	$V_{BAT} = 90\% \times V_{CHG}$, GND current during charge		$0.4\% \times I_{BAT}$		mA	
Under-Voltage Lockout Thresholds	V_{UVLOR}	V_{IN} rising	2.65	2.74	2.82	V	
	V_{UVLOF}	V_{IN} falling	2.33	2.42	2.50		
IN-BAT Offset Voltage	V_{OS}	$I_{IN} = 0.3mA$ to $80mA$, $V_{BAT} = 90\% \times V_{CHG}$	35	80	120	mV	
IN-BAT Forward Threshold Voltage ⁽¹⁾	V_{DH}	$V_{BAT} = 3V$, $I_{CHG} \leq 200mA$, charge current rise to $95\% \times I_{CHG}$		130	260	mV	
IN-BAT Reverse Threshold Voltage	V_{DL}			22		mV	
BAT Discharge Current	I_{OV_BAT}	$V_{BAT} = 104\% \times V_{CHG}$	1	1.5	2	mA	
BAT Activation Voltage Threshold	V_{BAT_ACT}	During the active charge time		2.74		V	
Normal Charge, Charge Termination							
Charge Voltage	V_{CHG}	Option voltage raster step		25		mV	
Charge Voltage Accuracy		$I_{BAT} = 1mA$	$T_J = +25^\circ C$	-20		20	mV
			$T_J = +2^\circ C$ to $+43^\circ C$	-25		25	
			$T_J = -40^\circ C$ to $+85^\circ C$	-32		28	
Floating Drop Ratio	V_{FCHG}/V_{CHG}	Percentage drop to the V_{CHG}	1.5	2	2.5	%	
Recharge Drop Ratio	V_{RECHG}/V_{CHG}	Percentage drop to the V_{CHG}	2.6	4	5.2	%	
Pre-Charge Voltage Ratio	V_{PRECHG}/V_{CHG}	Percentage to the V_{CHG}	62.5	65	67	%	
Charge Current	I_{CHG}	Option current raster step		50		mA	
Charge Current Accuracy		$V_{BAT} = 90\% \times V_{CHG}$, $I_{CHG} < 150mA$	$T_J = +25^\circ C$	-8		8	%
			$T_J = -40^\circ C$ to $+85^\circ C$	-10		10	
		$V_{BAT} = 90\% \times V_{CHG}$, $I_{CHG} \geq 150mA$	$T_J = +25^\circ C$	-5		5	%
			$T_J = -40^\circ C$ to $+85^\circ C$	-7		7	

ELECTRICAL CHARACTERISTICS (continued)

($V_{IN} = (V_{CHG(NOM)} + 0.5V)$ or 5V (whichever is greater), $V_{TSEN} = 0.4V$, $T_J = -40^\circ C$ to $+125^\circ C$, typical values are at $T_J = +25^\circ C$, unless otherwise noted.)

PARAMETER	SYMBOL	CONDITIONS	MIN	TYP	MAX	UNITS	
Normal Charge, Charge Termination							
Pre-Charge Current Ratio	I_{PRE}/I_{CHG}	Percentage to the I_{CHG} , $T_J = -40^\circ C$ to $+85^\circ C$	Ratio = 5%	2.8	5	7.2	%
			Ratio = 10%	7.0	10	13.0	
			Ratio = 15%	11.5	15	18.5	
			Ratio = 20%	15.5	20	24.5	
			Ratio = 25%	19.5	25	30.5	
End-of-Charge Current Ratio	I_{EOC}/I_{CHG}	Percentage to the I_{CHG} , $T_J = -40^\circ C$ to $+85^\circ C$	Ratio = 5%	3.0	4.8	6.6	%
			Ratio = 10%	7.4	9.8	12.2	
			Ratio = 15%	11.2	14.8	18.4	
			Ratio = 20%	15.2	19.6	24.0	
			Ratio = 25%	19.0	24	29.0	
Timings for Charge-Recycle, Floating Charge, Charge Termination							
Active Charging Time	t_{ACT}	Charging with I_{CHG} when starting from $V_{BAT} < V_{BAT_ACT}$		12.5		ms	
Charging Recycle Time	t_{HOLD}	The time holds previous charging state before recycle		650		ms	
Pre-Charge Voltage Deglitch Time ⁽²⁾	t_{D_TRK}	$T_J = -40^\circ C$ to $+85^\circ C$	2.4	3.8	5.2	ms	
Floating Charge Time ⁽²⁾	t_{FLT}	Floating time for $t_{FLT}/2 \sim t_{FLT}$ for charge termination, $T_J = -40^\circ C$ to $+85^\circ C$	37	45	53	min	
Pre-Charge Safety Time ⁽²⁾	t_{SAFE}	$T_J = -40^\circ C$ to $+85^\circ C$	74	94	114	min	
Operation Conditions and Limits							
NTC Sensing Current	I_{NTC_EN}	$V_{TSEN} = V_{HOT}$ to V_{COLD}	37.2	38.6	40.2	μA	
	I_{NTC_DIS}	$V_{TSEN} = 0V$	24.0	25.5	27.0		
Equivalent Resistance	$R_{0.5^\circ C}$	Reference to the NCP15XH103F03RC ($\beta 3380$)	26.74	27.37	28.00	k Ω	
	$R_{45^\circ C}$		4.836	4.95	5.064		
NTC Dismissal Threshold	V_{ENH}	TSEN rising	2.54	2.68	2.85	V	
NTC Dismissal Threshold Hysteresis	V_{ENH_HYS}	TSEN falling		30		mV	
NTC Cold Threshold	V_{COLD}	TSEN rising	1.035	1.057	1.080	V	
Cold Threshold Hysteresis	V_{COLD_HYS}	TSEN falling		165		mV	
NTC Hot Threshold	V_{HOT}	TSEN falling	182	191	200	mV	
Hot Threshold Hysteresis	V_{HOT_HYS}	TSEN rising		33		mV	
Shutdown Threshold	V_{ENL}	TSEN falling	92	102	112	mV	
Shutdown Threshold Hysteresis	V_{ENL_HYS}	TSEN rising		15		mV	
Thermal Fold-Back Threshold	T_{FOLD}			145		$^\circ C$	

NOTES:

- $V_{IN} - V_{BAT}$ need more than $95\% \times I_{CHG} \times R_{ON}$ when $I_{CHG} > 200mA$.
- Guaranteed by design and characterization. Not production tested.

TYPICAL PERFORMANCE CHARACTERISTICS

Measured by SGM41566-360F41, $V_{IN} = 5V$, $V_{TSEN} = 0.4V$, $T_J = +25^\circ C$, unless otherwise noted.

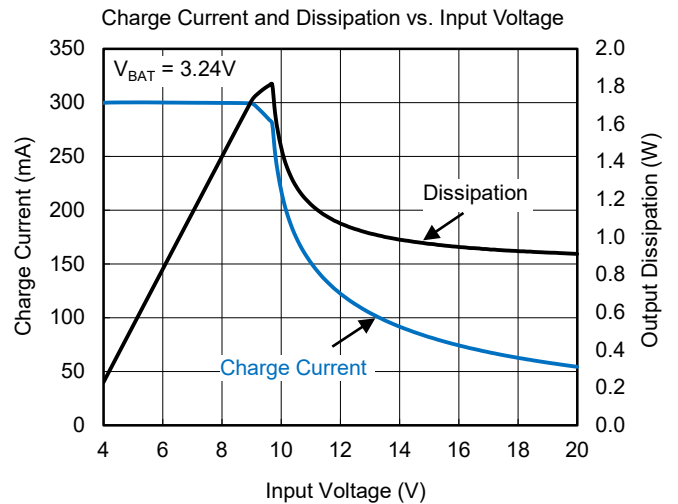
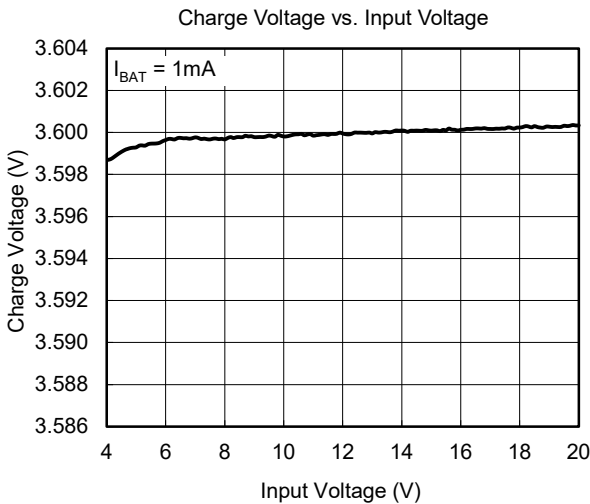
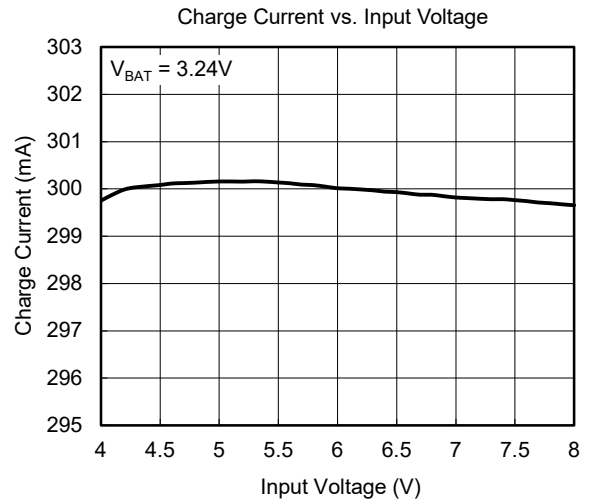
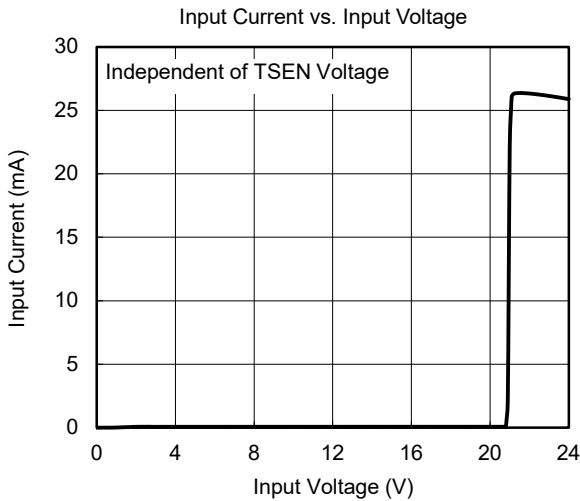
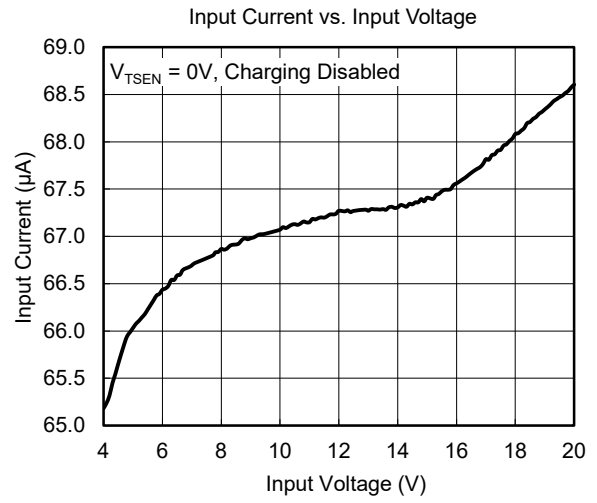
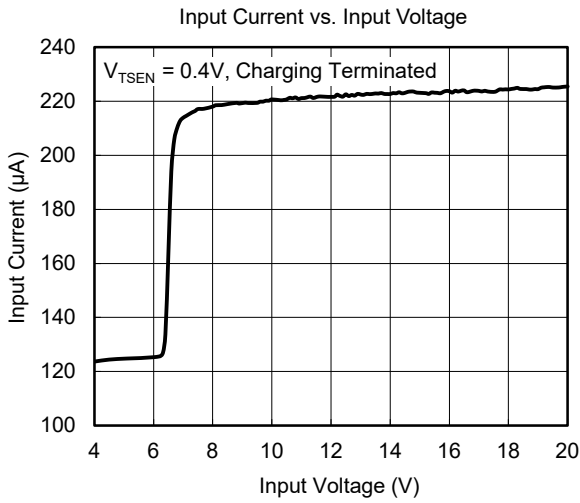

TYPICAL PERFORMANCE CHARACTERISTICS (continued)

Measured by SGM41566-360F41, $V_{IN} = 5V$, $V_{TSEN} = 0.4V$, $T_J = +25^\circ C$, unless otherwise noted.

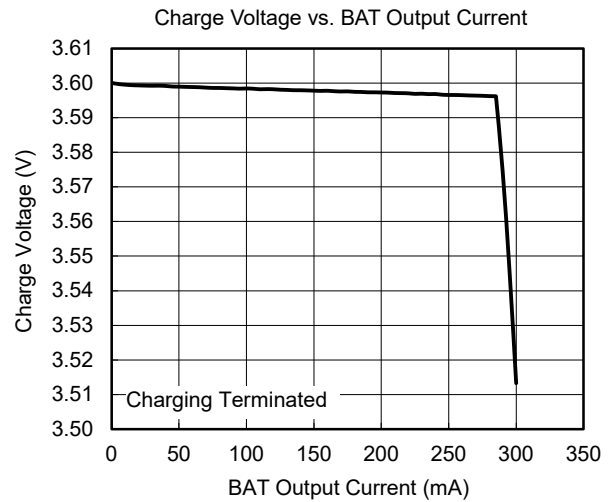
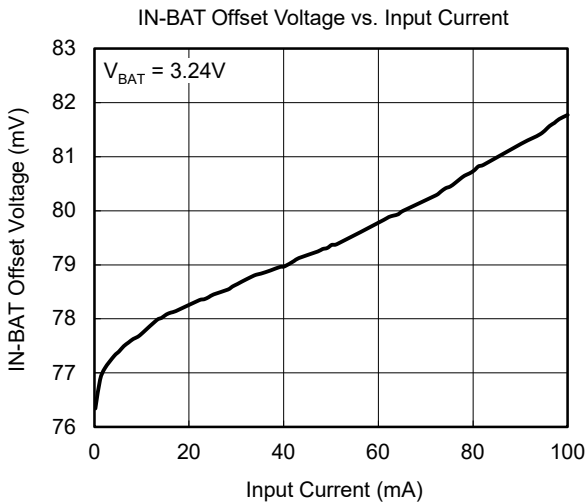
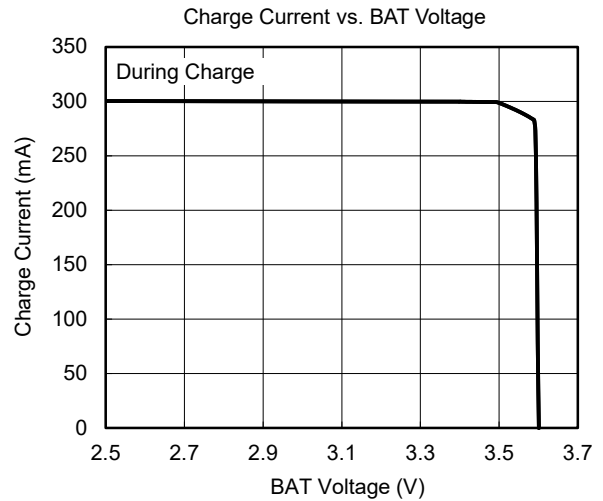
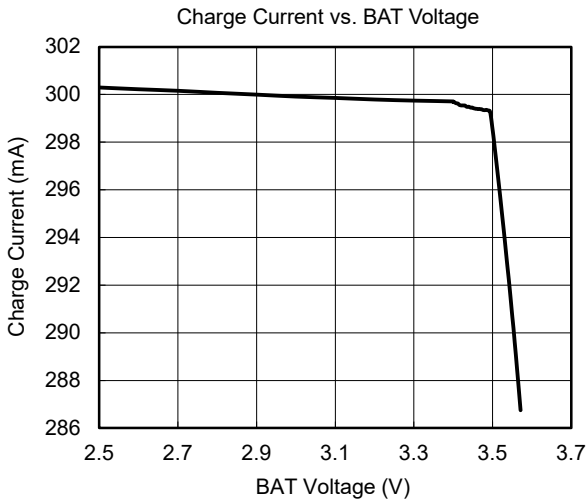
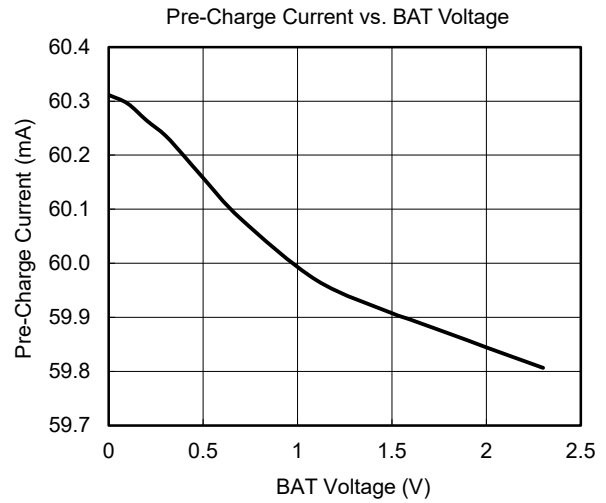
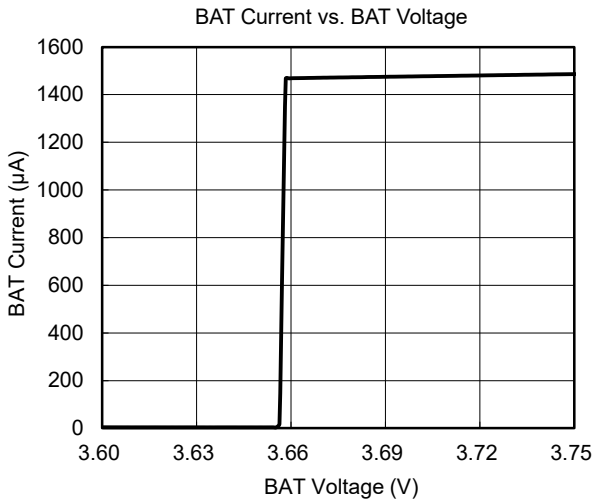

TYPICAL PERFORMANCE CHARACTERISTICS (continued)

Measured by SGM41566-360F41, $V_{IN} = 5V$, $V_{TSEN} = 0.4V$, $T_J = +25^\circ C$, unless otherwise noted.

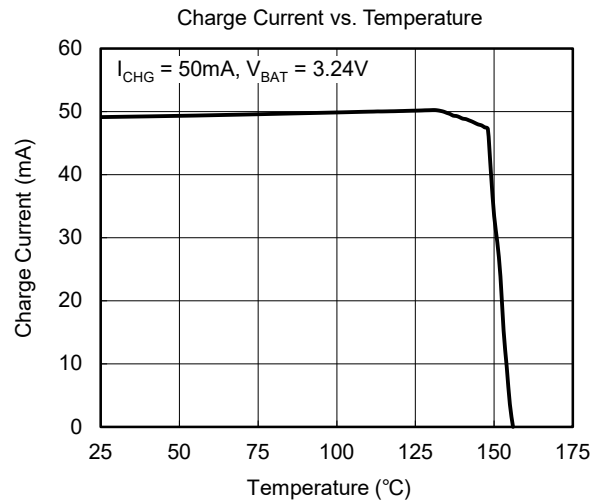
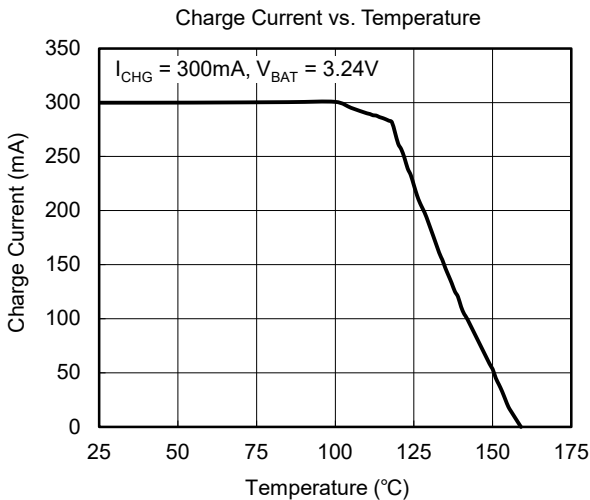
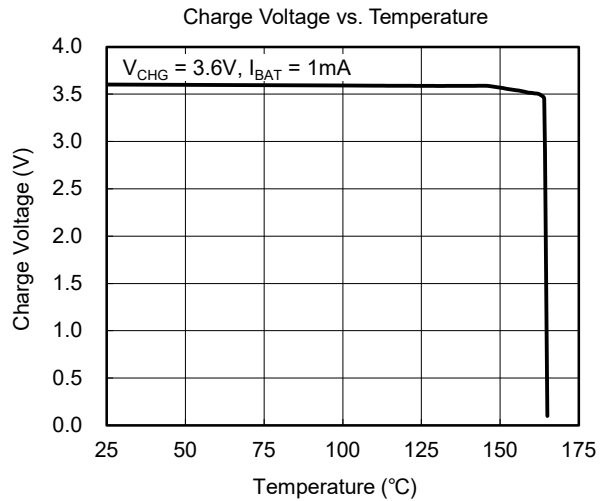
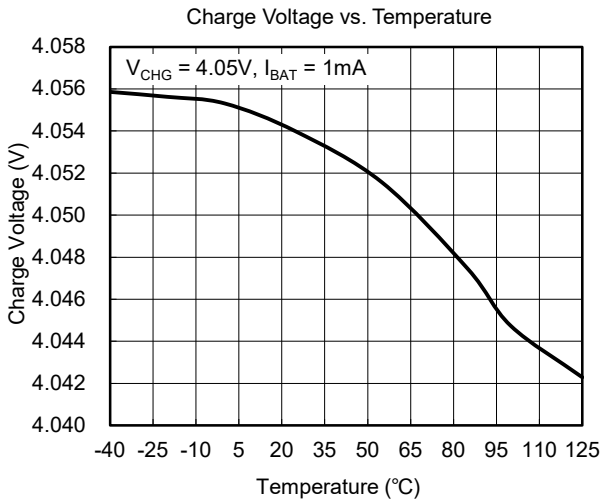
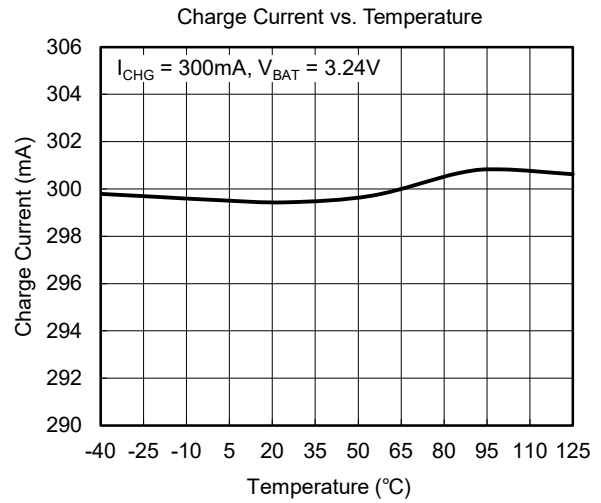
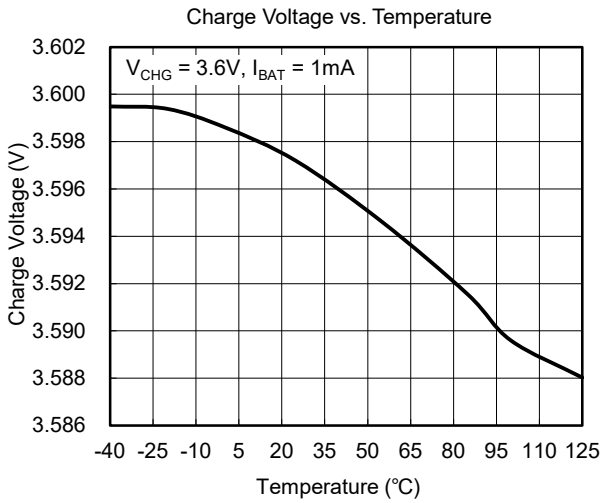

TYPICAL PERFORMANCE CHARACTERISTICS (continued)

Measured by SGM41566-360F41, $V_{IN} = 5V$, $V_{TSEN} = 0.4V$, $T_J = +25^\circ C$, unless otherwise noted.

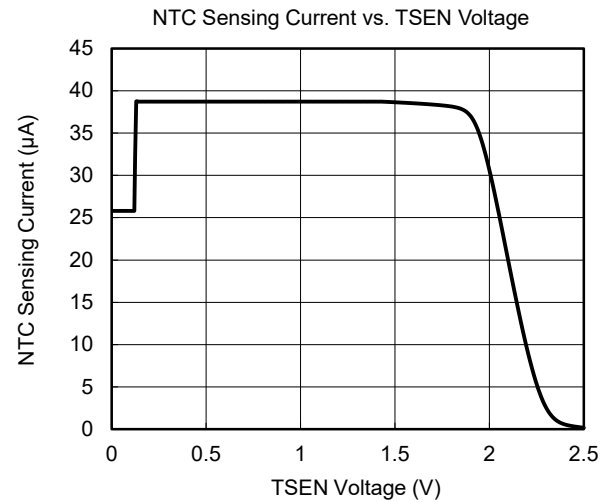
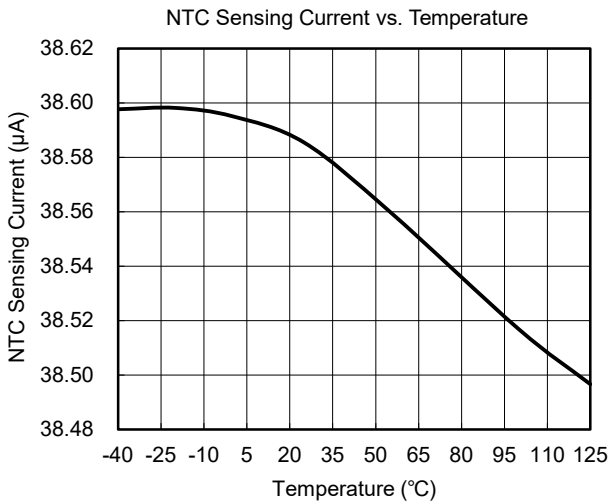
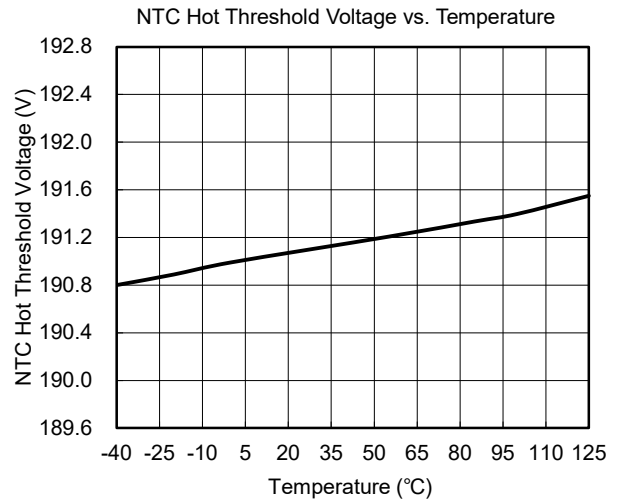
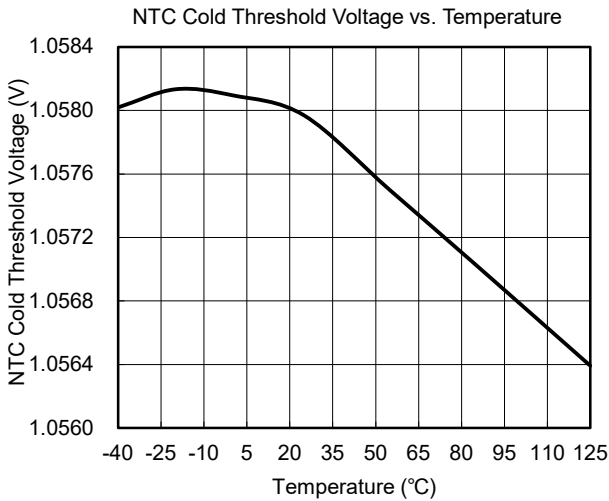
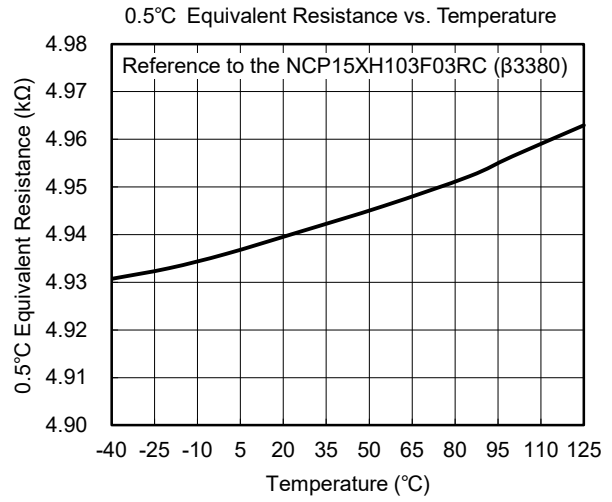
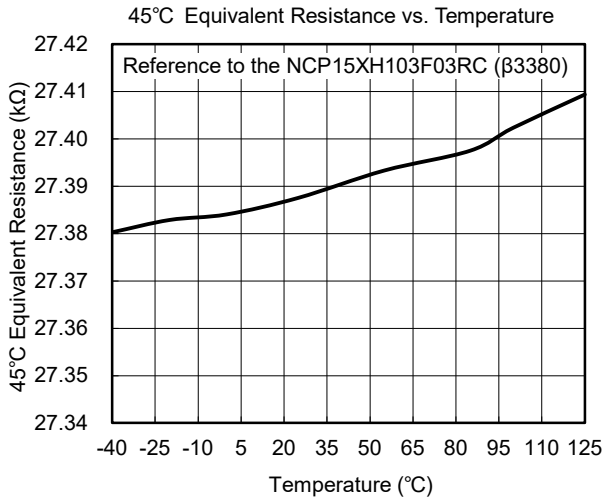

TYPICAL PERFORMANCE CHARACTERISTICS (continued)

Measured by SGM41566-360F41, $V_{IN} = 5V$, $V_{TSEN} = 0.4V$, $T_J = +25^\circ C$, unless otherwise noted.

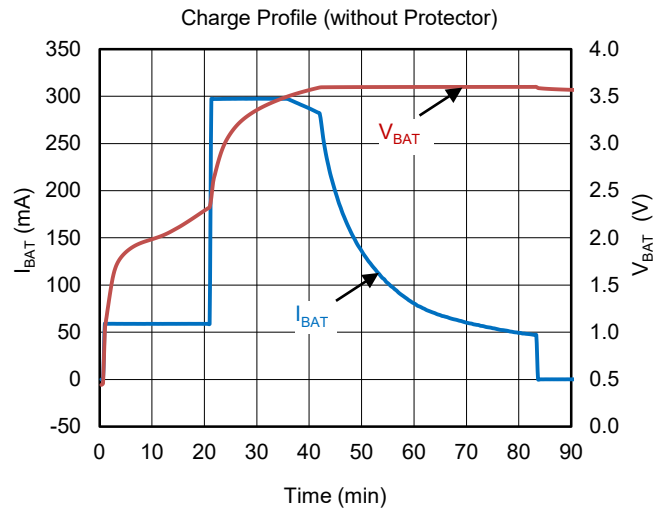
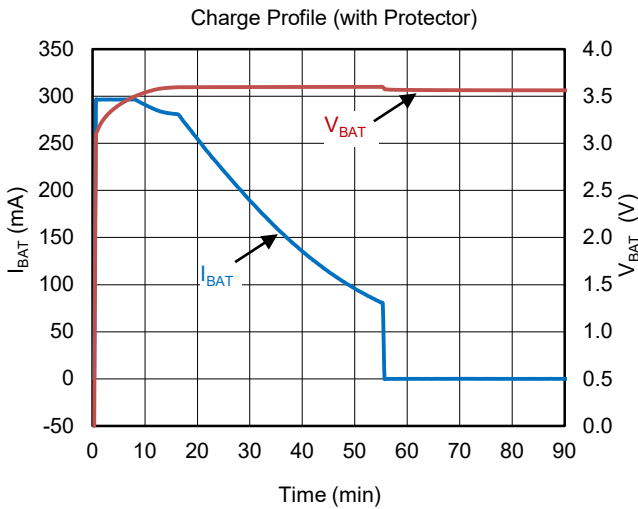
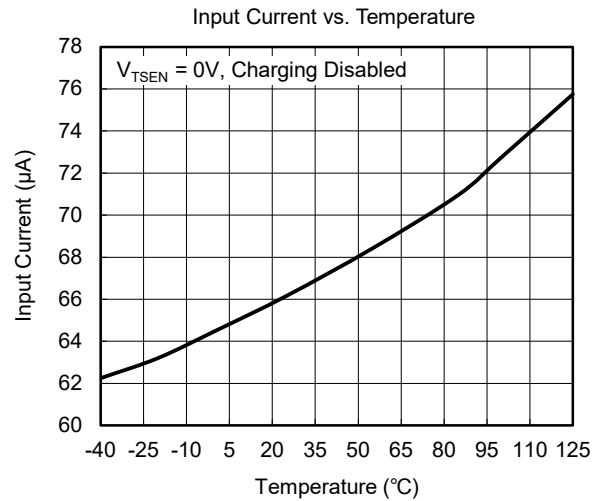
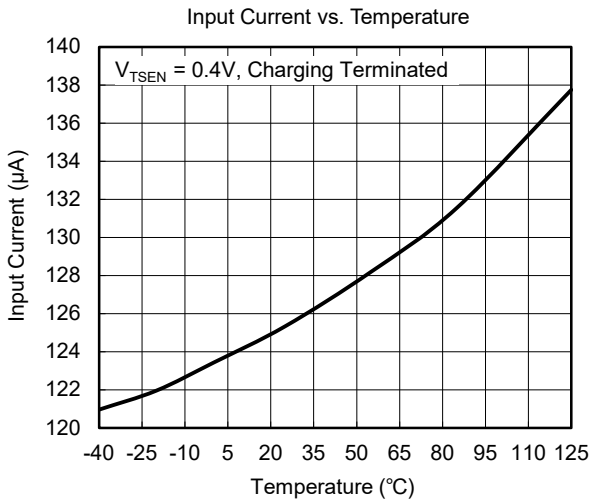
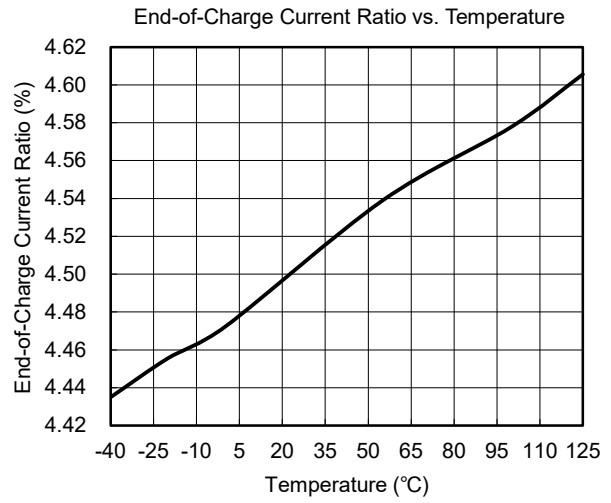
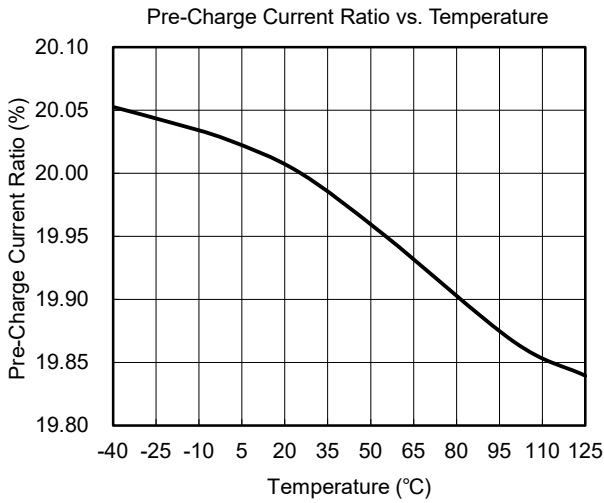

TYPICAL PERFORMANCE CHARACTERISTICS (continued)

Measured by SGM41566-360F41, $V_{IN} = 5V$, $V_{TSEN} = 0.4V$, $T_J = +25^\circ C$, unless otherwise noted.

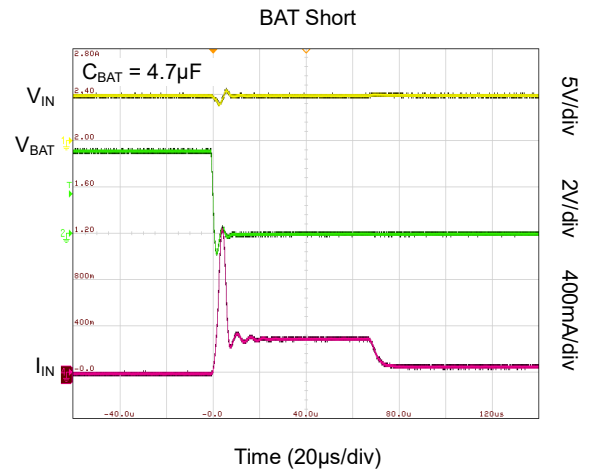
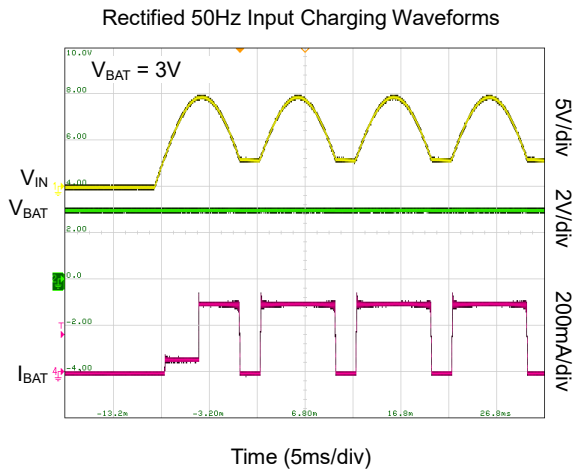
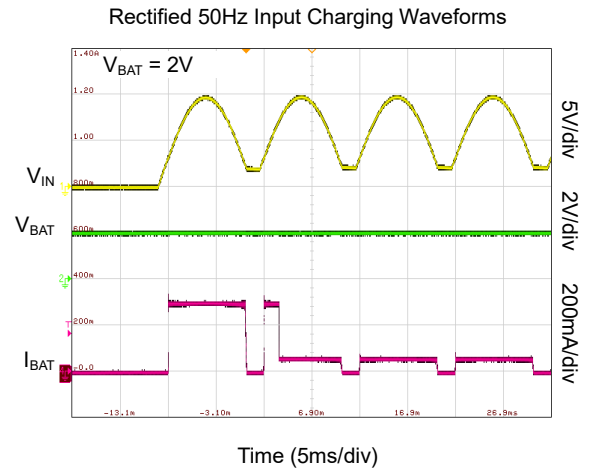
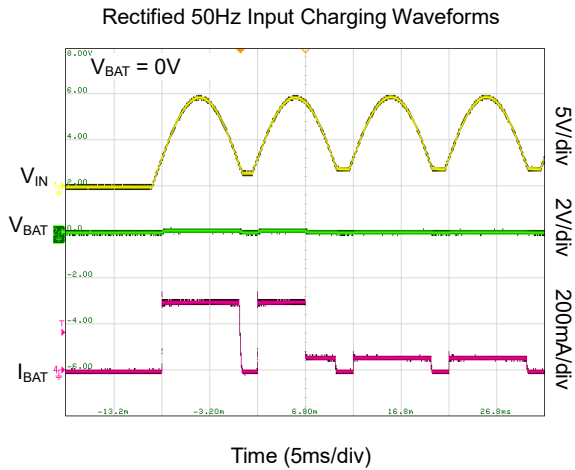
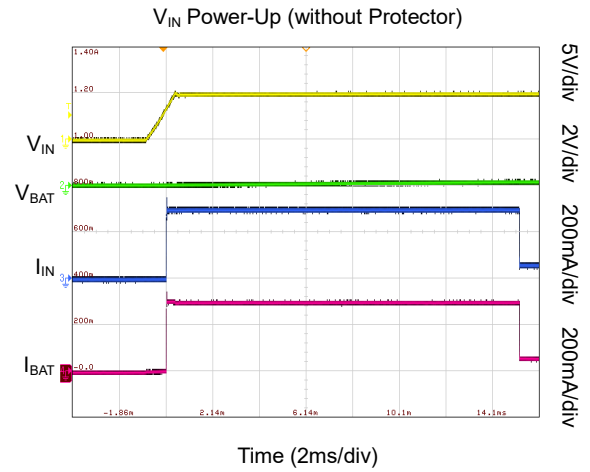
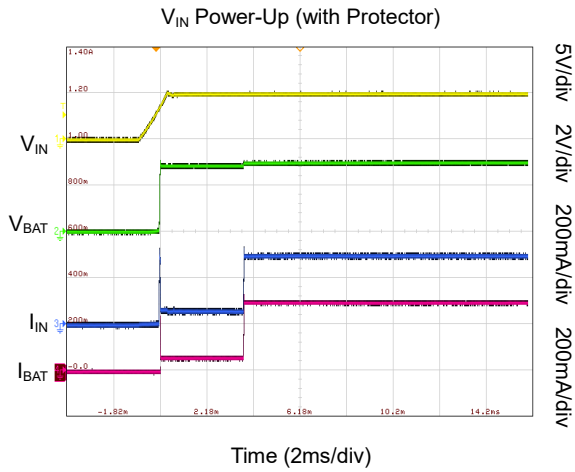

CHARGE CYCLE DIAGRAM

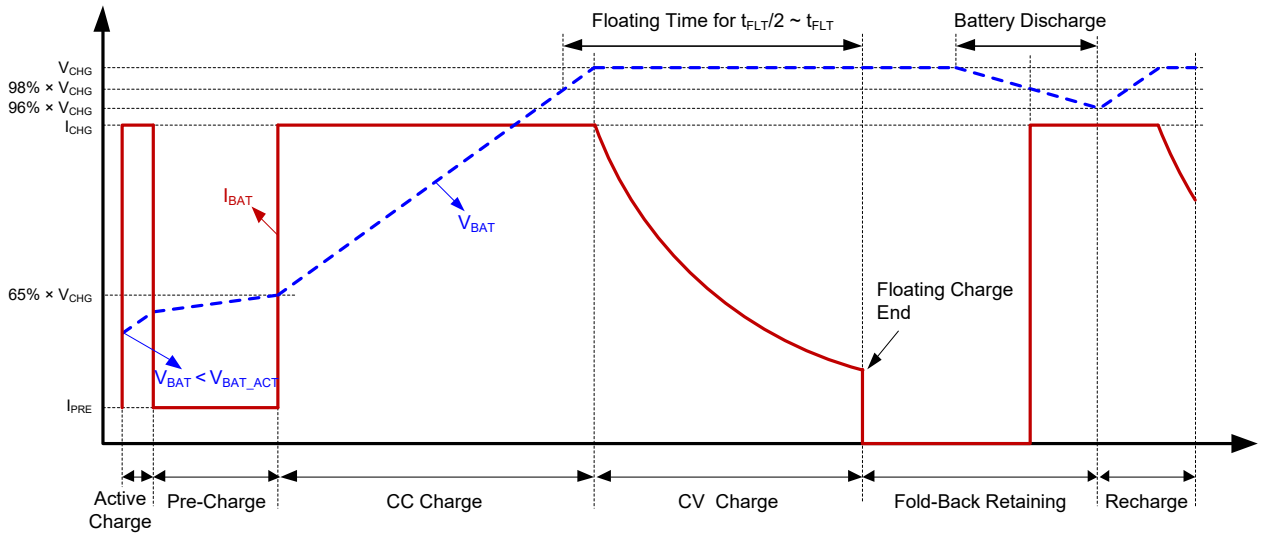

Figure 2. Not-Time Scaled Illustrative Charge Profile (with Active Charge)

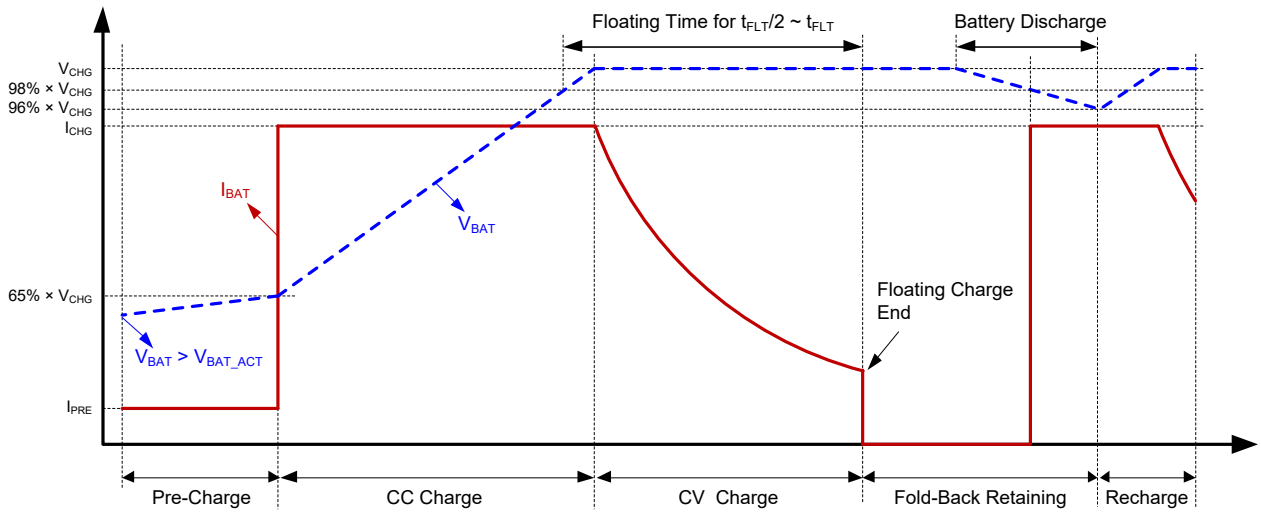

Figure 3. Not-Time Scaled Illustrative Charge Profile (without Active Charge)

FUNCTIONAL BLOCK DIAGRAM

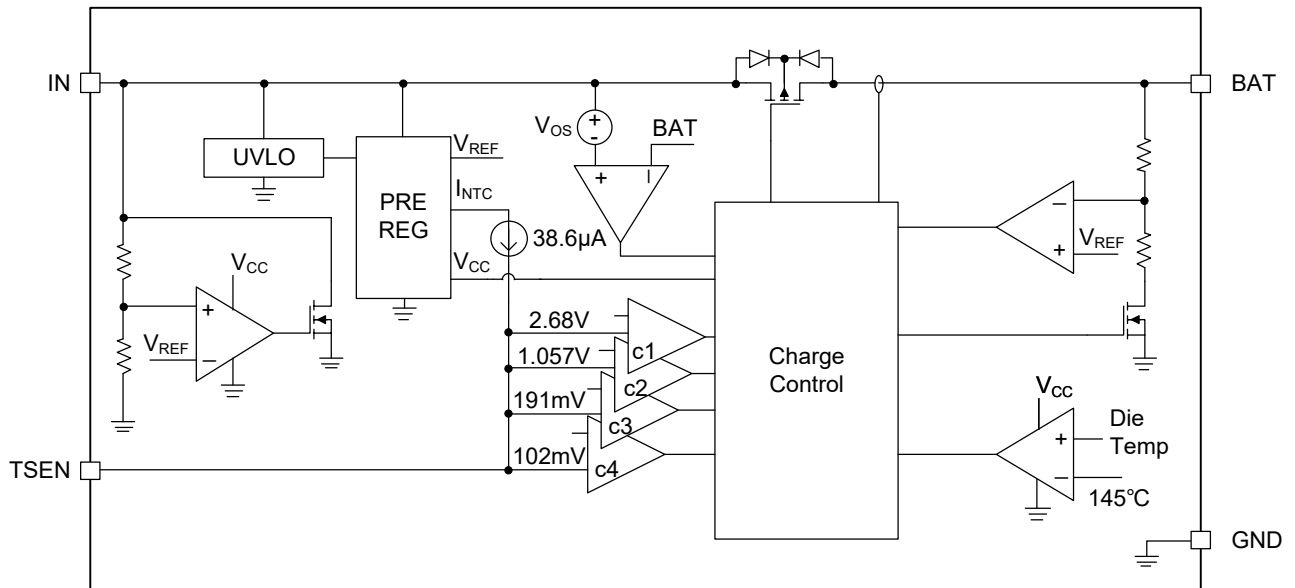

Figure 4. Block Diagram

DETAILED DESCRIPTION

The SGM41566 is a constant-voltage and constant-current profile charge regulator with the input condition check. It features with input clamp, output clamp, die temperature regulation, NTC temperature-oriented protection and floating charging protection. As shown in Figure 1, there are only few external components desired. Figure 2 and Figure 3 show the illustrative charge profiles.

System Start-Up Pre-Charge

When the input is applied and the BAT pin voltage is less than both the pre-charge threshold voltage and activation threshold voltage, the device outputs the constant normal charge current for t_{ACT} , which supplies for the system load to start up in no battery situation or the battery in protection off, before it turns into pre-charge where the output current may not be enough to start up the system.

Wide Charge Available Input Range

Charging is kept when the input voltage is higher than the nominal input range, or when the supply cannot keep voltage and current stable. The charge current is regulated to prevent over-heating when the input voltage is at the higher range end, and it keeps conduction and maintains minimum forward drop-out when the input voltage is at the lower range end. It can charge from pulse train input such as half-sine wave of rectified AC and slow change source like solar cell photo-voltage, while it keeps charge state flags until the internal bias losses or the input stays low for long enough.

Voltage Fold-Back Power Retaining

When the end-of-charge condition is certified, it lowers the output to the safe voltage V_{FCHG} , while keeping the current limit at the level of normal charge and retaining power to the load system. The design avoids frequent discharging and recharging cycling in the situation that charge supply is always attached.

Minimum Floating Charge Time

When the charging current with high system load that sinks more than the residual end-of-charge current and the battery voltage stays higher than the floating charge voltage for over t_{FLT} duration, the battery will stop charging and enter the end-of-charge fold-back power retaining state. As a weak source, it may also cause the current to fall to less than the residual end-of-charge

current, and minimum floating charge time $> t_{FLT}/2$ is a part of condition for full-of-charge certification.

Over-Temperature Charge Regulation

The device senses the die temperature. The thermal fold-back function starts to reduce the charge current when the internal temperature reaches the typical value of +145°C.

BAT Over-Voltage Protection

When any leakage or transient pulls V_{BAT} higher than $104\% \times V_{CHG}$ in charge, the BAT sinks current with 1.5mA clamp current for protection.

Full-of-Charge and Input Clamp

When the full-of-charge is certified, the input I_{IN} drops low and the output voltage steps down from V_{CHG} to V_{FCHG} . The sudden current changes the signals to the source side for turning into the full-of-charge state, and the source side can read the state by checking the output voltage or current. In case of wireless or contactless charging with high open load voltage, the device clamps its input voltage to about 21V with 26mA sinking.

NTC Temperature Sensing and Enable

The TSEN sources current (38.6μA) is used to read ground resistance for temperature-oriented protection. A grounded NTC thermistor is connected to the TSEN pin for temperature sensing. Charging is allowed only when the temperature is in suitable range. When a β3380 R₂₅ 10kΩ NTC is used, the precise upper and lower thresholds are 45°C and 0.5°C, respectively.

Pull the TSEN to ground to disable charge function, and pull the TSEN to high voltage $> 2.68V$ to dismiss the temperature-oriented protection function, while enables charge.

Pre-Charge Safety Time

To avoid further damage to bad battery or wrong system load, if the BAT pin voltage cannot reach $65\% \times V_{CHG}$ for over t_{SAFE} (94 minutes), the charging will be stopped. However, for the 50Hz rectified input voltage waveform, when the input voltage is lower than V_{UVLOf} , the SGM41566 has no such protection function.

This protection function is not available for the "No pre-charge" option.

REVISION HISTORY

NOTE: Page numbers for previous revisions may differ from page numbers in the current version.

Changes from Original (OCTOBER 2022) to REV.A	Page
Changed from product preview to production data.....	All

PACKAGE OUTLINE DIMENSIONS

TDFN-2x2-8AL

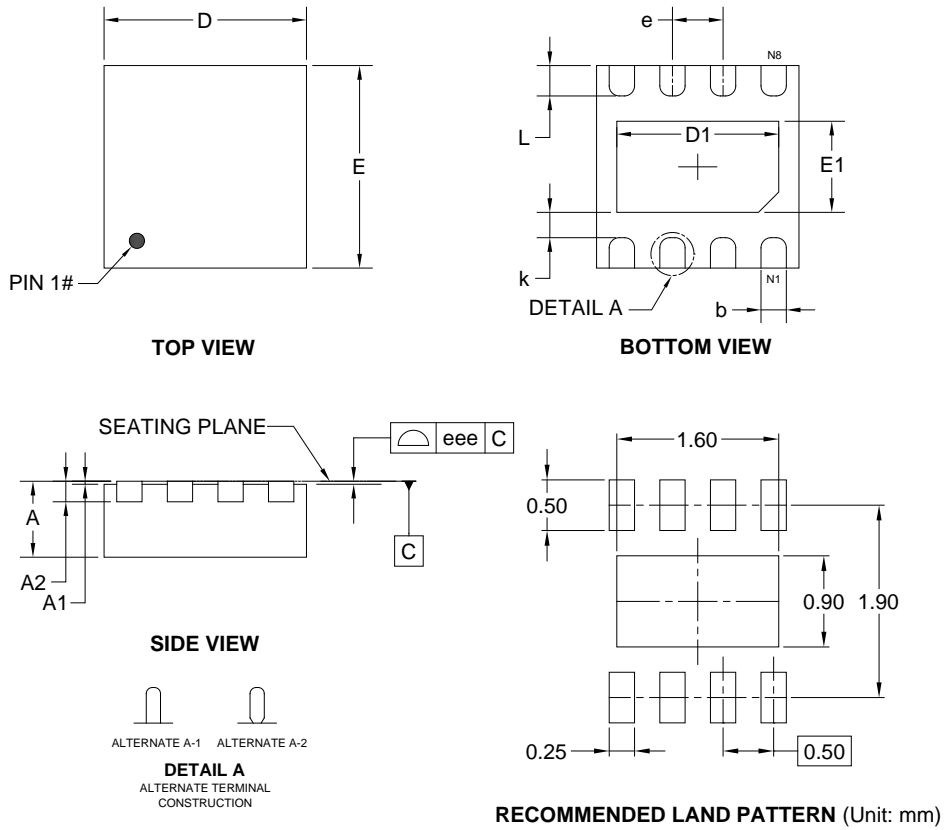

Symbol	Dimensions In Millimeters		
	MIN	MOD	MAX
A	0.700	0.750	0.800
A1	0.000	-	0.050
A2	0.203 REF		
b	0.200	0.250	0.300
D	1.900	2.000	2.100
D1	1.450	1.600	1.700
E	1.900	2.000	2.100
E1	0.750	0.900	1.000
k	0.150	0.250	0.350
e	0.450	0.500	0.550
L	0.200	0.300	0.400
eee	0.080		

NOTE: This drawing is subject to change without notice.

PACKAGE INFORMATION

TAPE AND REEL INFORMATION

REEL DIMENSIONS



TAPE DIMENSIONS



NOTE: The picture is only for reference. Please make the object as the standard.

KEY PARAMETER LIST OF TAPE AND REEL

Package Type	Reel Diameter	Reel Width W1 (mm)	A0 (mm)	B0 (mm)	K0 (mm)	P0 (mm)	P1 (mm)	P2 (mm)	W (mm)	Pin1 Quadrant
TDFN-2×2-8AL	7"	9.5	2.30	2.30	1.10	4.0	4.0	2.0	8.0	Q1

DD0001

PACKAGE INFORMATION

CARTON BOX DIMENSIONS



NOTE: The picture is only for reference. Please make the object as the standard.

KEY PARAMETER LIST OF CARTON BOX

Reel Type	Length (mm)	Width (mm)	Height (mm)	Pizza/Carton
7" (Option)	368	227	224	8
7"	442	410	224	18

DD0002