

Enhanced 50 Series Sensors



NanoView Series Sensors



SM Series Sensors



<b>5.0</b>	<b>Introduction</b>	
	Quick Reference Guide .....	V8-T5-2
	Technical Reference .....	V8-T5-4
	Product Selection Guide .....	V8-T5-6
<b>5.1</b>	<b>Enhanced 50 Series Sensors</b>	
	Product Description .....	V8-T5-9
	Product Selection .....	V8-T5-10
<b>5.2</b>	<b>NanoView Series Sensors</b>	
	Product Description .....	V8-T5-27
	Product Selection .....	V8-T5-28
<b>5.3</b>	<b>IntelliView Series Sensors</b>	
	Product Description .....	V8-T5-33
	Product Selection .....	V8-T5-34
<b>5.4</b>	<b>SM Series Sensors</b>	
	Product Description .....	V8-T5-48
	Product Selection .....	V8-T5-50
<b>5.5</b>	<b>Comet Series Sensors</b>	
	Product Description .....	V8-T5-54
	Product Selection .....	V8-T5-56
<b>5.6</b>	<b>Prism Series Sensors</b>	
	Product Description .....	V8-T5-69
	Product Selection .....	V8-T5-70
<b>5.7</b>	<b>OEM Prism Series Sensors</b>	
	Product Description .....	V8-T5-78
	Product Selection .....	V8-T5-79
<b>5.8</b>	<b>E58 Harsh Duty Series Sensors</b>	
	Product Description .....	V8-T5-84
	Product Selection .....	V8-T5-86
<b>5.9</b>	<b>E67 Long Range Perfect Prox Series Sensors</b>	
	Product Description .....	V8-T5-93
	Product Selection .....	V8-T5-94
<b>5.10</b>	<b>E51 Limit Switch Style, Modular Sensors</b>	
	Product Description .....	V8-T5-97
	Product Selection .....	V8-T5-98



**Unless otherwise noted, the products contained in this section should not be used for functional safety applications. These products were not designed or tested to IEC 60947-5-3 or recommended for functional safety.**



For Customer Service in the U.S. call 1-877-ETN CARE (386-2273),  
in Canada call 1-800-268-3578.  
For Application Assistance in the U.S. and Canada  
call 1-800-426-9184.

# Revision notes

## Volume 8—Sensing Solutions, CA08100010E

Tab 5—Photoelectric Sensors

Revision date	Section	Change page(s)	Description
09/08/2017	5.0	V8-T5-3	Content edit
09/08/2017	5.0	V8-T5-6, V8-T5-7	Content edit
09/08/2017	5.1	V8-T5-21, V8-T5-23	Content edit
09/08/2017	5.3	V8-T5-34	Content edit
09/08/2017	5.4	V8-T5-52	Content edit
09/08/2017	5.5	V8-T5-64	Content edit
09/08/2017	5.7	V8-T5-83	Content edit
09/08/2017	5.8	V8-T5-90	Content edit
09/08/2017	5.9	V8-T5-93	Content edit
09/08/2017	All	All	Revision date changed to September 2017



*Powering Business Worldwide*

### Quick Reference Guide

#### Photoelectric Sensors

5

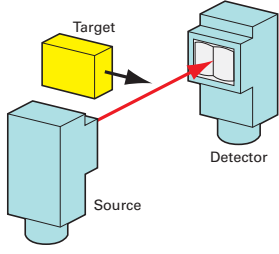
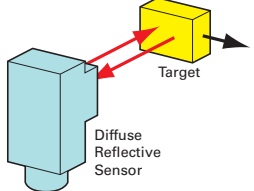
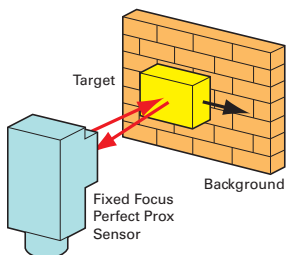
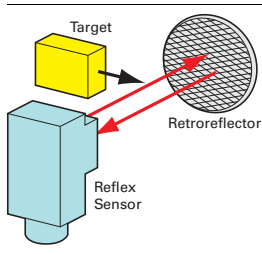
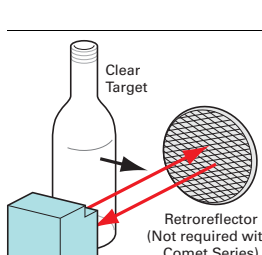
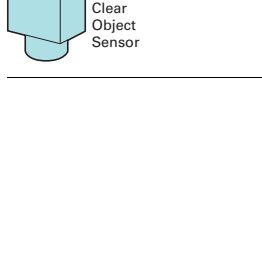
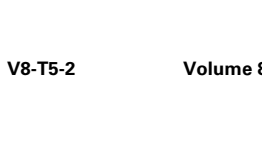
Sensing Application	Sensing Style	Maximum Range	Product Family	Page
	Through beam	500 ft (152 m)	Enhanced 50 Series™ Sensors	<b>V8-T5-9</b>
		50 ft (15 m)	SM Series™ Sensors	<b>V8-T5-48</b>
		80 ft (24 m)	Comet® Series Sensors	<b>V8-T5-54</b>
		20 ft (6 m)	Prism™ Series Sensors	<b>V8-T5-69</b>
		800 ft (250 m)	E58 Harsh Duty Series Sensors	<b>V8-T5-84</b>
		19 ft (6 m)	NanoView™ Series Sensors	<b>V8-T5-27</b>
	Diffuse reflective	10 ft (3 m)	Enhanced 50 Series Sensors	<b>V8-T5-9</b>
		2 ft (610 mm)	Comet Series Sensors	<b>V8-T5-54</b>
		8 in (200 mm)	SM Series Sensors	<b>V8-T5-48</b>
		8 in (200 mm)	Prism Series Sensors	<b>V8-T5-69</b>
		13.8 in (350 mm)	NanoView Series Sensors	<b>V8-T5-27</b>
	Fixed Focus Perfect Prox®	4 in (50 mm)	SM Series Sensors	<b>V8-T5-48</b>
		9 in (225 mm)	Comet Series Sensors	<b>V8-T5-54</b>
		11 in (280 mm)	E58 Harsh Duty Series Sensors	<b>V8-T5-84</b>
		79 in (200 cm)	E67 Long Range Perfect Prox Series Sensors	<b>V8-T5-93</b>
		3.9 in (100 mm)	NanoView Series Sensors	<b>V8-T5-27</b>
	Background suppression	47.2 in (120 cm)	IntelliView™ Series Sensors	<b>V8-T5-33</b>
	Standard reflex	30 ft (9 m)	Enhanced 50 Series Sensors	<b>V8-T5-9</b>
		25 ft (7.6 m)	Comet Series Sensors	<b>V8-T5-54</b>
		15 ft (4.5 m)	Prism Series Sensors	<b>V8-T5-69</b>
		59 ft (18 m)	E58 Harsh Duty Series Sensors	<b>V8-T5-84</b>
			Polarized reflex	16 ft (4.9 m)
15 ft (4.5 m)	Comet Series Sensors			<b>V8-T5-54</b>
10 ft (3 m)	SM Series Sensors			<b>V8-T5-48</b>
34 ft (10 m)	E58 Harsh Duty Series Sensors			<b>V8-T5-84</b>
8.2 ft (2.5 m)	NanoView Series Sensors			<b>V8-T5-27</b>
	Clear object detector	45 in (120 cm)	Enhanced 50 Series Sensors	<b>V8-T5-9</b>
		31.5 in (80 cm)	NanoView Series Sensors	<b>V8-T5-27</b>
		6 in (150 mm)	Comet Series Sensors (wide-angle)	<b>V8-T5-54</b>

Photoelectric Sensors, continued

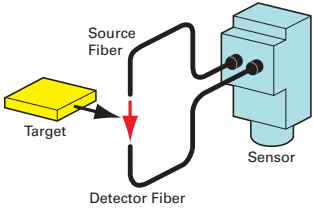
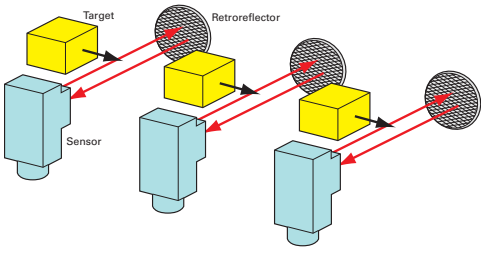
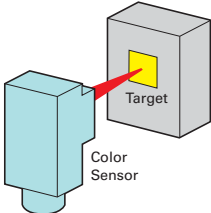
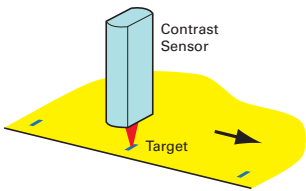
Sensing Application	Sensing Style	Maximum Range	Product Family	Page
	Fiber optic infrared LED glass cable	5.8 ft (1.77 m)	Enhanced 50 Series Sensors	<b>V8-T5-9</b>
	Fiber optic visible LED plastic cable	2.5 ft (762 mm)	Comet Series Sensors	<b>V8-T5-54</b>
	Conveyor sensor system	10 ft (3 m)	E68 Series™ Integral Sensor-Valve	<b>V8-T6-3</b>
		10 ft (3 m)	200 Series Zero Pressure Accumulation	<b>V8-T6-14</b>
	Color sensing	1.77 in (45 mm)	IntelliView Series Sensors	<b>V8-T5-33</b>
	Contrast sensing	0.39 in (10 mm)	IntelliView Series Sensors	<b>V8-T5-33</b>

## Technical Reference

### Photoelectric Sensors

5



### Introduction

Photoelectric sensors use light to detect the presence or absence of an object. The main advantages of photoelectric sensors are noncontact sensing of objects and greatly extended sensing ranges.

### Choosing the Right Sensor

There are many factors to consider when choosing a photoelectric sensor. The specific demands of your application will dictate the sensor required for the job. The following questions and suggested reference areas will help you select the best sensor for your application:

- What range is required (how far is the sensor from the object to be detected)? (See "Modes of Detection," "Range" and "Excess Gain")
- What is the nature of the environment? (See "Contamination")
- What access do you have to both sides of the object to be detected (is wiring possible on one or both sides of the object)? (See "Modes of Detection")
- What size is the object being detected? (See "Modes of Detection")
- Is the object consistent in size, shape, and reflectivity? (See "Modes of Detection, Perfect Prox")
- What are the mechanical and electrical requirements? (Check the electrical specifications of the desired sensor)
- What kind of output do you need? (Check the electrical specifications of the desired sensor)
- Are logic functions needed at the sensing point? (If so, look for sensors with logic modules or built-in logic functions)

**Modes of Detection**

**Thru-Beam**

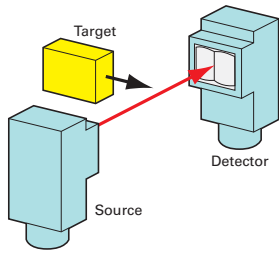

Source and detector elements are mounted in separate housings and aligned facing each other across an area which the target object crosses. Detection occurs when an object blocks the entire effective beam (the column of light that travels in a straight line between lenses). See **Page V8-T12-27**.

**Reflex**

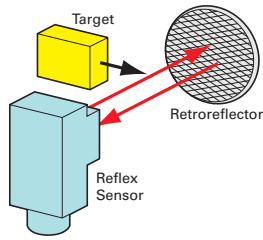

The source and detector are mounted in a single sensor housing and are positioned parallel to one another on the same side of the object to be detected. The light beam is transmitted from the source to a retroreflector that returns the light to the detector. Detection occurs when the target object blocks the entire effective beam. See **Page V8-T12-28**.

**Diffuse Reflective**

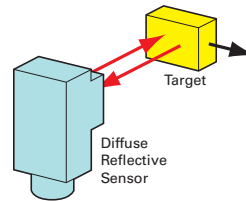

The source and detector elements are mounted in a single sensor housing and are positioned on the same side of the object to be detected and aligned with crossed fields of view. When the target moves into this area light from the source is reflected off the target surface back to the detector and detection occurs. See **Page V8-T12-28**.

**Perfect Prox**

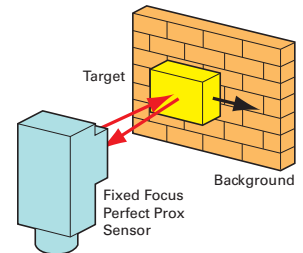

Perfect Prox is a special type of diffuse reflective sensor that combines extremely high sensing power (excess gain) with a sharp optical cutoff. This allows the sensor to reliably detect targets regardless of variations in color, reflectance, contrast or surface shape, while ignoring background objects that are just slightly beyond the target range. See **Page V8-T12-28**.

**Reflex Detection Mode**

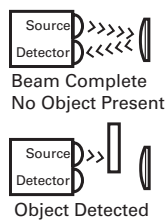

**Diffuse Reflective Detection Mode**

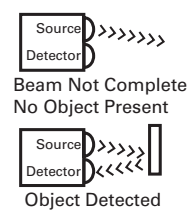

**Range**

Each sensor listed in this catalog has a specific operating range. In general, thru-beam sensors offer the greatest range (most power), followed by reflex and then diffuse reflective sensors. Operating ranges vary, and there is some overlap among types and models. See Applying Excess Gain on **Page V8-T12-30**.

**Excess Gain**

Excess gain is a measure of the sensing power available in excess of that required to detect an object. The following excess gain chart shows this measurement graphically. Find your required range on the x-axis of the graph. Then move up to the

curve to read the excess gain value from the y-axis. An excess gain value of 1 is the minimum level required for sensor operation. Eaton normally recommends excess gain levels  $\geq 10$  for reliable sensor operation. See **Page V8-T12-30**.

**Photoelectric Sensor Excess Gain Graph**

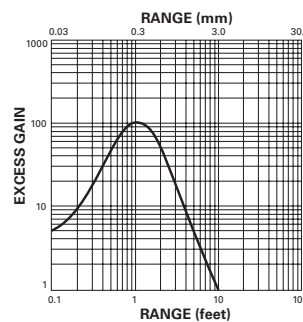

**Note:** The excess gain charts in this catalog represent the minimum excess gain provided by the sensor (unless otherwise noted). Actual performance may be better.

**Contamination**

The chart on **Page V8-T12-32** shows the excess gain recommended in environments with varying levels of contamination for each sensing mode.

### Product Selection Guide

#### Enhanced 50 Series Sensors



Page V8-T5-9

##### Overview

The Enhanced 50 Series™ family provides outstanding optical performance and application flexibility in a self-contained, industry-standard package.

##### Sensing Types and Ranges

Thru-beam: 200 and 500 ft  
 Reflex: 30 ft  
 Polarized reflex: 16 ft  
 Diffuse reflective: 5 and 10 ft  
 Clear object detector: 45 in  
 Infrared fiber optic: range varies with fiber  
 Visible fiber optic: range varies with fiber

##### Product Features

High optical performance including 10 ft diffuse and 500 ft thru-beam versions  
 Output options include a high-current 10 Amp SPDT relay  
 Built-in light/dark selection on all models  
 Logic options include ON-delay, OFF-delay and one-shot delay  
 Multiple connector and cable options  
 Industry standard package size

##### Technical Data and Specifications

Operating voltage—  
 24–240 Vac and 12–240 Vdc; 10–40 Vdc  
 Output function—  
 Selectable light or dark operate  
 Maximum load current—  
 DC units: 250 mA  
 AC/DC units: 300 mA to 10A  
 Enclosure ratings—  
 IP67, IP69  
 Response time range—  
 DC operation: 2 ms  
 AC operation: 15 ms

##### Approvals

CSA® Certified, 224447  
 Products certified by CSA for U.S.  
 CE  
 RoHS Compliant



#### NanoView Series Sensors



Page V8-T5-27

##### Overview

The NanoView™ Series from Eaton is a family of miniature rectangular photoelectric sensors designed for optimum value and sensing performance in a wide range of applications.

##### Sensing Types and Ranges

Thru-beam: 20 ft  
 Polarized reflex: 8.2 ft  
 Diffuse reflective: 13 in  
 Fixed focus diffuse: 4 in  
 Clear object detector: 2.6 ft

##### Product Features

Less than 1.5 in long and half an in deep  
 Fixed focus diffuse models sense very small targets at a 4-in focal point  
 Clear object detection models are ideal for sensing plastic bottles, molds, cartons, films and glass objects

##### Technical Data and Specifications

Input voltage—  
 10–30 Vdc  
 Output saturation voltage—  
 2V max.  
 Enclosure ratings—  
 Thru-beam: IP67  
 Polarized reflex: IP66  
 Diffuse reflective: IP66  
 Fixed focus diffuse: IP67  
 Clear object detector: IP66  
 Response time range—  
 1 ms max.

##### Approvals

UL® Listed, E166051  
 UL tested to Canadian safety standards  
 CE  
 RoHS Compliant



#### IntelliView Series Sensors



Page V8-T5-33

##### Overview

The IntelliView™ Series from Eaton is a family of compact, high performance specialty photoelectric sensors designed to solve a wide array of sensing challenges.

##### Sensing Types and Ranges

Foreground/background suppression  
 Distance sensing  
 Color, contrast, luminescence, and grayscale sensing

##### Product Features

Sensing technologies for detecting color, contrast, luminescence and distance— with great accuracy  
 Available in either compact rectangular or flat-tubular package sizes  
 Most models include a teach mode, allowing for quick and simple installation and setup  
 For the first time, Eaton offers a fully field-adjustable background suppression photoelectric sensor capable of detecting targets as far as 3.9 ft (47 in) away

##### Technical Data and Specifications

Input voltage—  
 Foreground models: 10–30 Vdc  
 Distance models: 16–28 Vdc  
 Output saturation voltage—  
 All models: < 2V max.  
 Enclosure ratings—  
 Foreground models:  
 E75-PPA\_: IP65  
 E75-PP1\_: IP67  
 Distance models: IP67  
 Response time range—  
 Varies by model

##### Approvals

UL Listed, E166051  
 UL tested to Canadian safety standards  
 CE  
 RoHS Compliant



#### SM Series Sensors



Page V8-T5-48

##### Overview

SM Series™ photoelectric sensors provide high performance and ease of use in an economical, compact package.

##### Sensing Types and Ranges

Thru-beam: 50 ft  
 Polarized reflex: 10 ft  
 Diffuse reflective: 8 in  
 Perfect Prox background rejection: 2 and 4 in

##### Product Features

Highly visible LED indicators for power, output and alignment (TargetLock™)  
 TargetLock™ simplifies setup and ensures that the sensor operates at the highest level of reliability possible  
 Perfect Prox models sense different colored targets at the same range and ignore objects in the background  
 Visible beam on all models lets you see exactly where the sensor is pointing  
 Small size  
 Reverse polarity, overload and short circuit protection on all models

##### Technical Data and Specifications

Operating voltage—  
 18–264 Vac and 18–50 Vdc; 10–30 Vdc  
 Output function—  
 Light and dark operate models available  
 Maximum load current—  
 AC/DC units—200 mA  
 DC units—100 mA (NPN or PNP)  
 Enclosure ratings—  
 NEMA® 1, 3, 4, 4X, 6, 6P, 12 and 13  
 IP68, IP69  
 Response time range—  
 DC operation: 1 ms  
 AC operation: 16 ms

##### Approvals

UL Listed, E166051  
 UL tested to Canadian safety standards  
 CE (DC models only)  
 RoHS Compliant



### Comet Series Sensors



#### Page V8-T5-54

#### Overview

This high performance, 18 mm tubular sensor family features a wide variety of models in all sensing modes to solve all of your sensing problems.

#### Sensing Types and Ranges

Thru-beam: 20 and 80 ft  
 Reflex: 25 ft  
 Polarized reflex: 15 and 10 ft  
 Diffuse reflective: 8 and 24 in  
 Focused diffuse reflective: 1.6 in  
 See **Page V8-T5-54** for wide angle diffuse and Perfect Prox information

#### Product Features

The 18 mm tubular body has flat sides for added mounting flexibility  
 Available in universal voltage AC/DC versions as well as DC only models  
 Short circuit protection on all models  
 RIM (Reaction Injection Molding) process completely encapsulates circuits and produces a rugged package

#### Technical Data and Specifications

Operating voltage—  
 90–132 Vac and 18–50 Vdc  
 20–264 Vac and 15–30 Vdc; 10–30 Vdc  
 Output function—  
 Selectable light or dark operate  
 Maximum load current—  
 AC/DC units—300 mA  
 DC units—250 mA (NPN), 100 mA (PNP)  
 Enclosure ratings—  
 NEMA 1, 2, 3, 4, 4X, 6, 12, 13 and IP69  
 Response time range—  
 DC operation: 1 ms/AC operation: 10 ms  
 2W AC/DC operation: 32 ms

#### Approvals

UL Recognized, E117028  
 CSA Certified, 50513  
 CE (DC models only)  
 RoHS Compliant



### Prism Series Sensors



#### Page V8-T5-69

#### Overview

Prism is a cost-effective line of 18 mm tubular photoelectric sensors with twice the optical gain of other sensors in this product class.

#### Sensing Types and Ranges

Thru-beam: 20 ft  
 Reflex: 15 ft  
 Polarized reflex: 10 ft  
 Diffuse reflective: 8 in  
 Glass fiber optic: range varies with fiber

#### Product Features

Isolated output simplifies wiring and allows each sensor to switch AC or DC loads, sink or source  
 Forward or right angle viewing units have identical optical performance  
 The 18 mm tubular body has flat sides for added mounting flexibility  
 Short circuit protection for loads less than 32 Vac or Vdc  
 High noise immunity  
 AC/DC and DC-only versions available

#### Technical Data and Specifications

Operating voltage—  
 20–132 Vac and 15–30 Vdc; 10–30 Vdc  
 Output function—  
 Isolated VMOS solid-state relay output  
 Light and dark operate models available  
 Maximum load current—  
 80 mA AC load  
 110 mA at 132 Vdc  
 Enclosure ratings—  
 NEMA 1, 2, 3, 4, 4X, 6, 12 and 13  
 Response time range—  
 3 ms

#### Approvals

UL Recognized, E117028  
 UL tested to Canadian safety standards  
 CE (DC reflex forward viewing only)



### OEM Prism Series Sensors



#### Page V8-T5-78

#### Overview

OEM Prism Sensors are similar to our standard cost-effective Prism family and are optimized for high volume OEM use.

#### Sensing Types and Ranges

Polarized reflex: 10 ft  
 Diffuse reflective: 8 and 24 in

#### Product Features

The 18 mm tubular body has flat sides for added mounting flexibility  
 Forward or right angle viewing units have identical optical performance  
 Sensors are shipped bulk-packaged for the convenience of high volume users  
 Dual discrete outputs for simple wiring  
 All models 10–30 Vdc only to meet the evolving needs of your customers

#### Technical Data and Specifications

Operating voltage—  
 10–30 Vdc  
 Output function—  
 Light and dark operate models available  
 Maximum load current—  
 100 mA  
 Enclosure ratings—  
 NEMA 1, 2, 3, 4, 4X, 6, 12 and 13  
 Response time range—  
 1.2 ms

#### Approvals

RoHS Compliant



### E58 Harsh Duty Series Sensors



#### Page V8-T5-84

#### Overview

E58 Harsh Duty Photoelectric Sensors were designed to withstand your harshest physical, chemical and optical environments, 18 and 30 mm tubular enclosures.

#### Sensing Types and Ranges

Thru-beam: 800 ft  
 Reflex: 59 ft  
 Polarized reflex: 34 ft  
 Perfect Prox background rejection: 2, 4, 6 and 11 in

#### Product Features

Designed to be the most rugged photoelectric sensor available  
 Perfect Prox background rejection technology for unmatched optical performance  
 Output status indicator is the brightest available and is visible from any angle and in any lighting condition  
 Available in universal voltage AC/DC versions as well as DC only models  
 18 mm and 30 mm models available

#### Technical Data and Specifications

Operating voltage—  
 See **Page V8-T5-84** for more information  
 Output function—  
 Light and dark operate models available  
 Maximum load current—  
 AC/DC units—300 mA (100 mA for 18 mm diameter units)  
 DC units—250 mA (NPN), 100 mA (PNP)  
 Enclosure ratings—  
 NEMA 1, 2, 3, 3R, 3S, 4, 4X, 6, 6P, 12, 12K, 13 and IP69  
 Response time range—  
 2 ms to 35 ms

#### Approvals

UL Listed, E166051  
 UL tested to Canadian safety standards  
 CE (DC models only)  
 RoHS Compliant





### E67 Long Range Perfect Prox Series Sensors



#### Page V8-T5-93

##### Overview

This is the highest performance long-range sensor you can buy with background rejection.

##### Sensing Types and Ranges

Perfect Prox 24 to 96 in  
Standard model pre-set at 6 ft. Fixed ranges of 2–8 ft are available.

##### Product Features

Extended sensing ranges (up to 8 ft) available with background rejection technology  
No user adjustments required  
Dual indicators communicate both output and power status from easy-to-see location on the top of the sensor  
AC/DC models offer isolated contact output for wiring flexibility  
DC sensors offer both NPN and PNP output  
Two mounting options for maximum flexibility

##### Technical Data and Specifications

Operating voltage—  
18–30 Vdc and 20–132 Vac/dc  
Output function—  
NPN and PNP (DC)  
Solid-state relay, 1500V isolation (AC/DC)  
Light and dark operate models available  
Maximum load current—  
100 mA DC  
75 mA AC/DC  
Enclosure ratings—  
NEMA 1, 2, 3, 4, 4X, 6, 12 and 13  
Response time range—  
50 ms (AC/DC) and 15 ms (DC)

##### Approvals

RoHS Compliant



### E51 Limit Switch Style, Modular Sensors



#### Page V8-T5-97

##### Overview

This versatile sensing family features modular construction, a variety of operating modes and a familiar limit switch style housing.

##### Sensing Types and Ranges

Thru-beam: 300 ft  
Reflex: 18 and 35 ft  
Polarized reflex: 15 ft  
Diffuse reflective: 8, 18 and 40 in  
Glass fiber optic: range varies with fiber

##### Product Features

Modular construction consisting of a head, sensor body and receptacle  
Most E51 photoelectric and inductive heads are interchangeable on all E51 sensor bodies for substantial inventory reduction  
Same general configurations and dimensions as the E50 limit switch  
Order as complete assemblies or components for stocking and manufacturing flexibility  
Keyed, for directional head positioning

##### Technical Data and Specifications

Operating voltage—  
20–264 Vac/dc; 120 Vac; 10–30 Vdc  
Output function—  
NO or NC (programmable); or NO and NC (complementary) sensor bodies are available  
Maximum load current—  
AC—1.0A continuous  
DC—0.6A continuous  
Enclosure ratings—  
NEMA 3, 3S, 4, 4X, 6, 6P and 13  
Class I, II, III, Division 2, Groups A, B, C, D, F and G (conduit entry only)  
Response time range—  
1 ms to 30 ms

##### Approvals

UL Listed, E166051, E183975  
CSA Certified, 50513



### Legacy Sensor Products

See **Tab 11** for product information and ordering information for these legacy products:

- E58 18 mm Tubular Series
- E64 Terminal Base Series
- E65 Miniature Series
- 11 Series
- 20 Series
- 50 Series
- 55 Series
- 60 Series
- 70 Series
- 80 Series

### Enhanced 50 Series Sensors



### Contents

<b>Description</b>	<b>Page</b>
Enhanced 50 Series Sensors	
Product Selection	
Thru-Beam Sensors . . . . .	<b>V8-T5-10</b>
Reflex Sensors . . . . .	<b>V8-T5-12</b>
Diffuse Sensors . . . . .	<b>V8-T5-14</b>
Clear Object Sensors . . . . .	<b>V8-T5-16</b>
Fiber Optic Sensors . . . . .	<b>V8-T5-17</b>
Compatible Connector Cables . . . . .	<b>V8-T5-19</b>
Fiber Optic Cables . . . . .	<b>V8-T5-20</b>
Accessories . . . . .	<b>V8-T5-21</b>
Technical Data and Specifications . . . . .	<b>V8-T5-21</b>
Excess Gain . . . . .	<b>V8-T5-22</b>
Wiring Diagrams . . . . .	<b>V8-T5-23</b>
Dimensions . . . . .	<b>V8-T5-24</b>

## Enhanced 50 Series Sensors

### Product Description

The new Enhanced versions of the 50 Series™ Photoelectric Sensors from Eaton's Electrical Sector offer flexibility, durability and high optical performance in a cost-effective self-contained package. Choose from three output types, four time delay functions, six sensing modes and four connection styles to tailor the sensor to exactly meet your needs.

Sensors are available in thru-beam, reflex, polarized reflex, diffuse reflective, clear object, and fiber optic sensing modes. Brackets are available for easy mounting and to allow precise adjustment of sensor alignment.

### Features

- High optical performance models including a 500 ft (152 m) thru-beam and a 10 ft (3 m) diffuse reflective unit
- Output options include a 3 Amp SPDT relay
- All units offer light/dark selection
- Logic options include ON-delay, OFF-delay, ON/OFF-delay and one-shot delay
- Fiber optic sensors operate in thru-beam or diffuse reflective mode depending on the fiber optic cable selected
- Fully potted construction for use in areas subject to washdown, high shock and/or vibration
- Choice of pre-wired power cable, built-in mini-connector, built-in micro-connector and pigtail micro-connector versions. Standard pre-wired cable length is 6 ft (2 m)
- Variety of brackets available including ball swivel

### Standards and Certifications

- CSA Certified, 224447
- Products certified by CSA for U.S.
- CE
- RoHS Compliant



### **⚠ DANGER**

**THIS SENSOR IS NOT A SAFETY DEVICE AND IS NOT INTENDED TO BE USED AS A SAFETY DEVICE. This sensor is designed only to detect and read certain data in an electronic manner and perform no use apart from that, specifically no safety-related use. This sensor product does not include self-checking redundant circuitry, and the failure of this sensor product could cause either an energized or de-energized output condition, which could result in death, serious bodily injury, or property damage.**

For the most current information on this product, visit our Web site: [www.eaton.com](http://www.eaton.com)

For Customer Service in the U.S. call 1-877-ETN CARE (386-2273), in Canada call 1-800-268-3578. For Application Assistance in the U.S. and Canada call 1-800-426-9184.

# 5.1

## Photoelectric Sensors

Enhanced 50 Series Sensors

### Product Selection Guide

#### Connection Options

##### Cable Version



##### Mini QD (Body)



##### Micro or Euro (Micro) QD (Body)



##### Micro or Euro (Micro) QD (Pigtail)



5

### Product Selection

#### Thru-Beam Sensors

Field of View: 2.4°



#### Thru-Beam Standard Range ①②

Voltage Range	Sensing Range	Optimum Range	Sensing Beam	Thru-Beam Component	Output Type	Time Delay	Connection Type	Catalog Number	
10–40 Vdc	200 ft (61 m)	0.1 to 100 ft (0.03 to 31 m)	Infrared	Source	N/A	N/A	6 ft cable	<b>1150E-6517</b>	
				Detector	NPN/PNP 250 mA	no		<b>1250E-6517</b>	
						yes		<b>1250E-8517</b>	
				Source	N/A	N/A	4-pin Euro (micro) connector	<b>1150E-6547</b> ☹	
								Detector	NPN/PNP 250 mA
				yes	<b>1250E-8547</b> ☹				
				Source	N/A	N/A		4-pin Euro (micro) connector (pigtail)	<b>1150E-6537</b> ☹
									Detector
				yes	<b>1250E-8537</b> ☹				
				Source	N/A	N/A	4-pin mini-connector	<b>1150E-6507</b> ☹	
								Detector	NPN/PNP 250 mA
				yes	<b>1250E-8507</b> ☹				
12–240 Vdc 24–240 Vac	200 ft (61 m)	0.1 to 100 ft (0.03 to 31 m)	Infrared	Source	N/A	N/A	6 ft cable	<b>1150E-6513</b>	
				Detector	Isolated output solid-state relay 300 mA at 240 Vac/dc	no		<b>1250E-6513</b>	
						yes		<b>1250E-8513</b>	
				Source	N/A	N/A	4-pin micro-connector	<b>1150E-6514</b>	
								Detector	SPDT EM relay 3A at 120 Vac
				yes	<b>1250E-8514</b>				
				Source	N/A	N/A		4-pin micro-connector (pigtail)	<b>1150E-6543</b> ☹
									Detector
				yes	<b>1250E-8543</b> ☹				
				Source	N/A	N/A	4-pin micro-connector (pigtail)	<b>1150E-6534</b> ☹	
								Detector	Isolated output solid-state relay 300 mA at 240 Vac/dc
				yes	<b>1250E-8533</b> ☹				
				Source	N/A	N/A	5-pin micro-connector (pigtail)	<b>1250E-6534</b> ☹	
								Detector	SPDT EM relay 3A at 120 Vac
				yes	<b>1250E-8534</b> ☹				
				Source	N/A	N/A	4-pin mini-connector	<b>1150E-6504</b> ☹	
								Detector	Isolated output solid-state relay 300 mA at 240 Vac/dc
				yes	<b>1250E-8503</b> ☹				
Source	N/A	N/A	5-pin mini-connector	<b>1250E-6504</b> ☹					
				Detector	SPDT EM relay 3A at 120 Vac	no	<b>1250E-8504</b> ☹		
yes	<b>1250E-8504</b> ☹								

#### Notes

☹☹ See listing of compatible connector cables on **Page V8-T5-19**.

① For a complete system, order one sensor and one detector.

② For brackets compatible with these sensors, see Accessories on **Page V8-T5-21**.

Field of View: 2.4°



### Thru-Beam Extended Range ①②

Voltage Range	Sensing Range	Optimum Range	Sensing Beam	Thru-Beam Component	Output Type	Time Delay	Connection Type	Catalog Number	
10–40 Vdc	500 ft (152 m)	0.1 to 250 ft (0.03 to 77 m)	Infrared	Source	N/A	N/A	6 ft cable	<b>1151E-6517</b>	
				Detector	NPN/PNP 250 mA	no		<b>1251E-6517</b>	
						yes		<b>1251E-8517</b>	
				Source	N/A	N/A	4-pin Euro (micro) connector	<b>1151E-6547</b> ☹	
				Detector	NPN/PNP 250 mA	no		<b>1251E-6547</b> ☹	
						yes		<b>1251E-8547</b> ☹	
				Source	N/A	N/A	4-pin Euro (micro) connector (pigtail)	<b>1151E-6537</b> ☹	
				Detector	NPN/PNP 250 mA	no		<b>1251E-6537</b> ☹	
						yes		<b>1251E-8537</b> ☹	
				Source	N/A	N/A	4-pin mini-connector	<b>1151E-6507</b> ☹	
				Detector	NPN/PNP 250 mA	no		<b>1251E-6507</b> ☹	
						yes		<b>1251E-8507</b> ☹	
12–240 Vdc 24–240 Vac	500 ft (152 m)	0.1 to 250 ft (0.03 to 77 m)	Infrared	Source	N/A	N/A	6 ft cable	<b>1151E-6513</b>	
				Detector	Isolated output solid-state relay 300 mA at 240 Vac/dc	no		<b>1251E-6513</b>	
						yes		<b>1251E-8513</b>	
							SPDT EM relay 3A at 120 Vac	no	<b>1251E-6514</b>
						yes		<b>1251E-8514</b>	
				Source	N/A	N/A		4-pin micro-connector	<b>1151E-6543</b> ☹
				Detector	Isolated output solid-state relay 300 mA at 240 Vac/dc	no	<b>1251E-6543</b> ☹		
						yes	<b>1251E-8543</b> ☹		
				Source	N/A	N/A	4-pin micro-connector (pigtail)	<b>1151E-6534</b> ☹	
				Detector	Isolated output solid-state relay 300 mA at 240 Vac/dc	no		<b>1251E-6533</b> ☹	
						yes		<b>1251E-8533</b> ☹	
							SPDT EM relay 3A at 120 Vac	no	<b>1251E-6534</b> ☹
		yes	<b>1251E-8534</b> ☹						
Source	N/A	N/A	4-pin mini-connector	<b>1151E-6504</b> ☹					
Detector	Isolated output solid-state relay 300 mA at 240 Vac/dc	no		<b>1251E-6503</b> ☹					
		yes		<b>1251E-8503</b> ☹					
			SPDT EM relay 3A at 120 Vac	no	<b>1251E-6504</b> ☹				
		yes		<b>1251E-8504</b> ☹					

#### Notes

☹☹ See listing of compatible connector cables on [Page V8-T5-19](#).

① For a complete system, order one sensor and one detector.

② For brackets compatible with these sensors, see [Accessories on Page V8-T5-21](#).

# 5.1

## Photoelectric Sensors

### Enhanced 50 Series Sensors

#### Reflex Sensors

Field of View: 1.0°



#### Standard Reflex <sup>①②</sup>

Voltage Range	Sensing Range <sup>③</sup>	Optimum Range <sup>③</sup>	Sensing Beam	Output Type	Time Delay	Connection Type	Catalog Number					
10–40 Vdc	30 ft (9 m)	0.5 to 15 ft (0.2 to 4.6 m)	Visible red	NPN/PNP 250 mA	no	6 ft cable	<b>1450E-6517</b>					
					yes		<b>1450E-8517</b>					
					no	4-pin Euro (micro) connector	<b>1450E-6547</b> Ⓢ					
					yes		<b>1450E-8547</b> Ⓢ					
					no	4-pin Euro (micro) connector (pigtail)	<b>1450E-6537</b> Ⓢ					
					yes		<b>1450E-8537</b> Ⓢ					
					no	4-pin mini-connector	<b>1450E-6507</b> Ⓢ					
					yes		<b>1450E-8507</b> Ⓢ					
					12–240 Vdc 24–240 Vac	30 ft (9 m)	0.5 to 15 ft (0.2 to 4.6 m)	Visible red	Isolated output solid-state relay 300 mA at 240 Vac/dc	no	6 ft cable	<b>1450E-6513</b>
										yes		<b>1450E-8513</b>
										no	4-pin micro-connector	<b>1450E-6543</b> Ⓢ
										yes		<b>1450E-8543</b> Ⓢ
										no	4-pin micro-connector (pigtail)	<b>1450E-6533</b> Ⓢ
										yes		<b>1450E-8533</b> Ⓢ
no	4-pin mini-connector	<b>1450E-6503</b> Ⓢ										
yes		<b>1450E-8503</b> Ⓢ										
SPDT EM relay 3A at 120 Vac	no	6 ft cable	<b>1450E-6514</b>									
	yes		<b>1450E-8514</b>									
	no	5-pin micro-connector (pigtail)	<b>1450E-6534</b> Ⓢ									
	yes		<b>1450E-8534</b> Ⓢ									
	no	5-pin mini-connector	<b>1450E-6504</b> Ⓢ									
	yes		<b>1450E-8504</b> Ⓢ									

#### Notes

Ⓢ Ⓢ See listing of compatible connector cables on **Page V8-T5-19**.

① For a complete system, order one sensor and one retroreflector (see **Tab 8, section 8.1**).

② For brackets compatible with these sensors, see Accessories on **Page V8-T5-21**.

③ Ranges based on 3 in retroreflector for reflex sensors.

Field of View: 1.0°



**Polarized Reflex** ①②③

Voltage Range	Sensing Range ④	Optimum Range ④	Sensing Beam	Output Type	Time Delay	Connection Type	Catalog Number					
10–40 Vdc	16 ft (4.9 m)	0.5 to 8 ft (0.2 to 2.5 m)	Visible red	NPN/PNP 250 mA	no	6 ft cable	<b>1451E-6517</b>					
						yes		<b>1451E-8517</b>				
					no	4-pin Euro (micro) connector	<b>1451E-6547</b> Ⓢ					
							yes	<b>1451E-8547</b> Ⓢ				
					no	4-pin Euro (micro) connector (pigtail)	<b>1451E-6537</b> Ⓢ					
							yes	<b>1451E-8537</b> Ⓢ				
					no	4-pin mini-connector	<b>1451E-6507</b> Ⓢ					
							yes	<b>1451E-8507</b> Ⓢ				
					12–240 Vdc 24–240 Vac	16 ft (4.9 m)	0.5 to 8 ft (0.2 to 2.5 m)	Visible red	Isolated output solid-state relay 300 mA at 240 Vac/dc	no	6 ft cable	<b>1451E-6513</b>
											yes	
										no	4-pin micro-connector	<b>1451E-6543</b> Ⓢ
												yes
no	4-pin micro-connector (pigtail)	<b>1451E-6533</b> Ⓢ										
		yes	<b>1451E-8533</b> Ⓢ									
no	4-pin mini-connector	<b>1451E-6503</b> Ⓢ										
		yes	<b>1451E-8503</b> Ⓢ									
SPDT EM relay 3A at 120 Vac										no	6 ft cable	<b>1451E-6514</b>
											yes	
										no	5-pin micro-connector (pigtail)	<b>1451E-6534</b> Ⓢ
												yes
					no	5-pin mini-connector	<b>1451E-6504</b> Ⓢ					
							yes	<b>1451E-8504</b> Ⓢ				

**Notes**

- ⓈⓈ See listing of compatible connector cables on **Page V8-T5-19**.
- ① For a complete system, order one sensor and one retroreflector (see **Tab 8, section 8.1**).
- ② Polarized sensors may not operate with reflective tape. Test tape selection before installation.
- ③ For brackets compatible with these sensors, see Accessories on **Page V8-T5-21**.
- ④ Ranges based on 3 in retroreflector for reflex sensors.

# 5.1

## Photoelectric Sensors

### Enhanced 50 Series Sensors

#### Diffuse Sensors

Field of View: 2.8°



5

#### Diffuse Reflective ①

Voltage Range	Sensing Range ②	Optimum Range ②	Sensing Beam	Output Type	Time Delay	Connection Type	Catalog Number				
10–40 Vdc	5 ft (1.5 m)	1 to 30 in (25 to 760 mm)	Infrared	NPN/PNP 250 mA	no	6 ft cable	<b>1350E-6517</b>				
					yes		<b>1350E-8517</b>				
					no	4-pin Euro (micro) connector	<b>1350E-6547</b> ☹				
					yes		<b>1350E-8547</b> ☹				
					no	4-pin Euro (micro) connector (pigtail)	<b>1350E-6537</b> ☹				
					yes		<b>1350E-8537</b> ☹				
				no	4-pin mini-connector	<b>1350E-6507</b> ☹					
				yes		<b>1350E-8507</b> ☹					
				12–240 Vdc 24–240 Vac	5 ft (1.5 m)	1 to 30 in (25 to 760 mm)	Infrared	Isolated output solid-state relay 300 mA at 240 Vac/dc	no	6 ft cable	<b>1350E-6513</b>
									yes		<b>1350E-8513</b>
									no	4-pin micro-connector	<b>1350E-6543</b> ☹
									yes		<b>1350E-8543</b> ☹
no	4-pin micro-connector (pigtail)	<b>1350E-6533</b> ☹									
yes		<b>1350E-8533</b> ☹									
no	4-pin mini-connector	<b>1350E-6503</b> ☹									
yes		<b>1350E-8503</b> ☹									
SPDT EM relay 3A at 120 Vac	no	6 ft cable	<b>1350E-6514</b>								
	yes		<b>1350E-8514</b>								
	no	5-pin micro-connector (pigtail)	<b>1350E-6534</b> ☹								
	yes		<b>1350E-8534</b> ☹								
	no	5-pin mini-connector	<b>1350E-6504</b> ☹								
	yes		<b>1350E-8504</b> ☹								

#### Notes

☹☹ See listing of compatible connector cables on **Page V8-T5-19**.

① For brackets compatible with these sensors, see Accessories on **Page V8-T5-21**.

② Ranges based on 90% reflectance white card for diffuse reflective sensors.

Field of View: 2.8°



### Diffuse Reflective Extended Range ①

Voltage Range	Sensing Range ②	Optimum Range ②	Sensing Beam	Output Type	Time Delay	Connection Type	Catalog Number					
10–40 Vdc	10 ft (3 m)	1 to 60 in (25 to 1520 mm)	Infrared	NPN/PNP 250 mA	no	6 ft cable	<b>1351E-6517</b>					
					yes		<b>1351E-8517</b>					
					no	4-pin Euro (micro) connector	<b>1351E-6547</b> ☹					
					yes		<b>1351E-8547</b> ☹					
					no	4-pin Euro (micro) connector (pigtail)	<b>1351E-6537</b> ☹					
					yes		<b>1351E-8537</b> ☹					
					no	4-pin mini-connector	<b>1351E-6507</b> ☹					
					yes		<b>1351E-8507</b> ☹					
					12–240 Vdc 24–240 Vac	10 ft (3 m)	1 to 60 in (25 to 1520 mm)	Infrared	Isolated output solid-state relay 300 mA at 240 Vac/dc	no	6 ft cable	<b>1351E-6513</b>
										yes		<b>1351E-8513</b>
										no	4-pin micro-connector	<b>1351E-6543</b> ☹
										yes		<b>1351E-8543</b> ☹
no	4-pin micro-connector (pigtail)	<b>1351E-6533</b> ☹										
yes		<b>1351E-8533</b> ☹										
no	4-pin mini-connector	<b>1351E-6503</b> ☹										
yes		<b>1351E-8503</b> ☹										
SPDT EM relay 3A at 120 Vac										no	6 ft cable	<b>1351E-6514</b>
										yes		<b>1351E-8514</b>
										no	5-pin micro-connector (pigtail)	<b>1351E-6534</b> ☹
										yes		<b>1351E-8534</b> ☹
					no	5-pin mini-connector	<b>1351E-6504</b> ☹					
					yes		<b>1351E-8504</b> ☹					

#### Notes

☹☹ See listing of compatible connector cables on **Page V8-T5-19**.

① For brackets compatible with these sensors, see Accessories on **Page V8-T5-21**.

② Ranges based on 90% reflectance white card for diffuse reflective sensors.



# 5.1

## Photoelectric Sensors

### Enhanced 50 Series Sensors

#### Clear Object Sensors

Field of View: 0.68°



#### Clear Object Detector <sup>①②</sup>

Voltage Range	Sensing Range	Optimum Range	Sensing Beam	Output Type	Time Delay	Connection Type	Catalog Number					
10–40 Vdc	45 in (1.2 m)	1 to 24 in (25 to 610 mm)	Visible red	NPN/PNP 250 mA	no	6 ft cable	<b>1452E-6517</b>					
					yes		<b>1452E-8517</b>					
					no	4-pin Euro (micro) connector	<b>1452E-6547</b> ☹					
					yes		<b>1452E-8547</b> ☹					
					no	4-pin Euro (micro) connector (pigtail)	<b>1452E-6537</b> ☹					
					yes		<b>1452E-8537</b> ☹					
					no	4-pin mini-connector	<b>1452E-6507</b> ☹					
					yes		<b>1452E-8507</b> ☹					
					12–240 Vdc 24–240 Vac	45 in (1.2 m)	1 to 24 in (25 to 610 mm)	Visible red	Isolated output solid-state relay 300 mA at 240 Vac/dc	no	6 ft cable	<b>1452E-6513</b>
										yes		<b>1452E-8513</b>
										no	4-pin micro-connector	<b>1452E-6543</b> ☹
										yes		<b>1452E-8543</b> ☹
										no	4-pin micro-connector (pigtail)	<b>1452E-6533</b> ☹
										yes		<b>1452E-8533</b> ☹
no	4-pin mini-connector	<b>1452E-6503</b> ☹										
yes		<b>1452E-8503</b> ☹										
SPDT EM relay 3A at 120 Vac	no	6 ft cable	<b>1452E-6514</b>									
	yes		<b>1452E-8514</b>									
	no	5-pin micro-connector (pigtail)	<b>1452E-6534</b> ☹									
	yes		<b>1452E-8534</b> ☹									
	no	5-pin mini-connector	<b>1452E-6504</b> ☹									
	yes		<b>1452E-8504</b> ☹									

#### Notes

☹☹ See listing of compatible connector cables on **Pages V8-T5-19** and **V8-T5-20**.

① For a complete system, order one sensor and one retroreflector (see **Tab 8, section 8.1**).

② For brackets compatible with these sensors, see Accessories on **Page V8-T5-21**.

Fiber Optic Sensors

Field of View: ②③④



Fiber Optic Infrared ①

Voltage Range	Sensing Range	Optimum Range	Sensing Beam	Output Type	Time Delay	Connection Type	Catalog Number				
10–40 Vdc	Depends on fiber selected ⑤	Depends on fiber selected	Infrared	NPN/PNP 250 mA	no	6 ft cable	1550E-6517				
					yes		1550E-8517				
					no	4-pin Euro (micro) connector	1550E-6547 ②				
					yes		1550E-8547 ②				
					no	4-pin Euro (micro) connector (pigtail)	1550E-6537 ②				
					yes		1550E-8537 ②				
				no	4-pin mini-connector	1550E-6507 ②					
				yes		1550E-8507 ②					
				12–240 Vdc 24–240 Vac	Depends on fiber selected ⑤	Depends on fiber selected	Infrared	Isolated output solid-state relay 300 mA at 240 Vac/dc	no	6 ft cable	1550E-6513
									yes		1550E-8513
									no	4-pin micro-connector	1550E-6543 ②
									yes		1550E-8543 ②
no	4-pin micro-connector (pigtail)	1550E-6533 ②									
yes		1550E-8533 ②									
no	4-pin mini-connector	1550E-6503 ②									
yes		1550E-8503 ②									
SPDT EM relay 3A at 120 Vac	no	6 ft cable	1550E-6514								
	yes		1550E-8514								
	no	5-pin micro-connector (pigtail)	1550E-6534 ②								
	yes		1550E-8534 ②								
	no	5-pin mini-connector	1550E-6504 ②								
	yes		1550E-8504 ②								

Notes

- ②③④ See listing of compatible connector cables on **Pages V8-T5-19** and **V8-T5-20**.
- ① For brackets compatible with these sensors, see **Accessories** on **Page V8-T5-21**.
- ② Field of view depends on fiber selected.
- ③ For a complete system, order one sensor and one fiber optic cable (see **Pages V8-T5-19** and **V8-T5-20**).
- ④ Infrared fiber optic sensors are compatible with glass fiber optic cables (E51KE\_).
- ⑤ Diffuse mode—up to 6 in (152 mm); thru-beam—up to 35 in (890 mm).

# 5.1

## Photoelectric Sensors

### Enhanced 50 Series Sensors

Field of View: ②③④



#### Fiber Optic Visible ①

Voltage Range	Sensing Range	Optimum Range	Sensing Beam	Output Type	Time Delay	Connection Type	Catalog Number				
10–40 Vdc	Depends on fiber selected ⑤	Depends on fiber selected	Infrared	NPN/PNP 250 mA	no	6 ft cable	<b>1551E-6517</b>				
					yes		<b>1551E-8517</b>				
					no	4-pin Euro (micro) connector	<b>1551E-6547</b> ☹				
					yes		<b>1551E-8547</b> ☹				
					no	4-pin Euro (micro) connector (pigtail)	<b>1551E-6537</b> ☹				
					yes		<b>1551E-8537</b> ☹				
				no	4-pin mini-connector	<b>1551E-6507</b> ☹					
				yes		<b>1551E-8507</b> ☹					
				12–240 Vdc 24–240 Vac	Depends on fiber selected ⑤	Depends on fiber selected	Infrared	Isolated output solid-state relay 300 mA at 240 Vac/dc	no	6 ft cable	<b>1551E-6513</b>
									yes		<b>1551E-8513</b>
									no	4-pin micro-connector	<b>1551E-6543</b> ☹
								yes		<b>1551E-8543</b> ☹	
no	4-pin micro-connector (pigtail)	<b>1551E-6533</b> ☹									
yes		<b>1551E-8533</b> ☹									
SPDT EM relay 3A at 120 Vac					no	6 ft cable	<b>1551E-6514</b>				
					yes		<b>1551E-8514</b>				
					no	5-pin micro-connector (pigtail)	<b>1551E-6534</b> ☹				
				yes		<b>1551E-8534</b> ☹					
				no	5-pin mini-connector	<b>1551E-6504</b> ☹					
				yes		<b>1551E-8504</b> ☹					

#### Notes



- ☹☹ See listing of compatible connector cables on **Page V8-T5-19**.
- ① For brackets compatible with these sensors, see Accessories on **Page V8-T5-21**.
- ② Field of view depends on fiber selected.
- ③ For a complete system, order one sensor and one fiber optic cable (see **Page V8-T5-20**).
- ④ Visible fiber optic sensors are compatible with plastic fiber optic cables only.
- ⑤ Diffuse mode—up to 3 in (76 mm); thru-beam—up to 35 in (890 mm).

Compatible Connector Cables

Micro-Style,  
Straight Female





Standard Cables—Micro ①

Voltage Style	Number of Pins	Gauge	Length	Pin Configuration/ Wire Colors (Face View Female Shown)	PVC Jacket Catalog Number	PUR Jacket Catalog Number	IRR PUR Jacket Catalog Number
<b>Micro-Style, Straight Female</b>							
AC Micro	4-pin, 4-wire	22 AWG	6 ft (2 m)	 1-Red/Black 2-Red/White 3-Red 4-Green	CSAS4F4CY2202	CSAS4F4RY2202	CSAS4F4IO2202
	5-pin, 5-wire	22 AWG	6 ft (2 m)	 1-Brown 2-Blue 3-Gray 4-Black 5-White	CSAS5A5CY2202	—	—
DC	4-pin, 4-wire	22 AWG	6 ft (2 m)	 1-Brown 2-White 3-Blue 4-Black	CSDS4A4CY2202	CSDS4A4RY2202	CSDS4A4IO2202

Mini-Style,  
Straight Female



Standard Cables—Mini ①

Current Rating at 600V	Voltage Style	Number of Pins	Gauge	Length	Pin Configuration/ Wire Colors (Face View Female Shown)	Catalog Number
<b>Mini-Style, Straight Female</b>						
8A	AC/DC	4-pin, 4-wire	16 AWG	6 ft (2 m)	 1-Black 2-Blue 3-Brown 4-White	CSMS4A4CY1602
		5-pin, 5-wire	16 AWG	6 ft (2 m)	 1-Black 2-Blue 3-Orange 4-Brown 5-White	CSMS5A5CY1602

Note

① For a full selection of connector cables, see **Tab 10, section 10.1**.

# 5.1

## Photoelectric Sensors

### Enhanced 50 Series Sensors

5

#### Fiber Optic Cables





#### Glass Fiber Optic Cables

##### Glass Fiber Optic Cables—Duplex Cables (for Diffuse Reflective Sensing)

Sensing Tip Style	Fiber Bundle Size A in In (mm)	Stainless Steel Jacket Catalog Number	PVC/Monocoil Jacket Catalog Number
 Forward Viewing, Unthreaded	<b>Forward Viewing, Unthreaded</b>		
	0.125 (3.2)	E51KE713	E51KE313
 Right Angle Viewing, Unthreaded	<b>Right Angle Viewing, Unthreaded</b>		
	0.125 (3.2)	E51KE733	E51KE333
 Forward Viewing, Threaded Cable End	<b>Forward Viewing, Threaded Cable End</b>		
	0.125 (3.2)	E51KE723	E51KE323
 Right Angle Viewing, Threaded Cable Shaft	<b>Right Angle Viewing, Threaded Cable Shaft</b>		
	0.125 (3.2)	E51KE7A3	E51KE3A3
 Right Angle Viewing, Threaded Cable End	<b>Right Angle Viewing, Threaded Cable End</b>		
	0.125 (3.2)	E51KE7B3	E51KE3B3

Dimensions, see Page V8-T5-25.



##### Glass Fiber Optic Cables—Single Cables (for Thru-Beam Sensing)

Sensing Tip Style	Fiber Bundle Size A in In (mm)	Stainless Steel Jacket Catalog Number	PVC/Monocoil Jacket Catalog Number
 Forward Viewing, Unthreaded	<b>Forward Viewing, Unthreaded</b>		
	0.125 (3.2)	E51KE813	E51KE413
 Right Angle Viewing, Unthreaded	<b>Right Angle Viewing, Unthreaded</b>		
	0.125 (3.2)	E51KE833	E51KE433
 Forward Viewing, Threaded Cable End	<b>Forward Viewing, Threaded Cable End</b>		
	0.125 (3.2)	E51KE823	E51KE423
 Right Angle Viewing, Threaded Cable Shaft	<b>Right Angle Viewing, Threaded Cable Shaft</b>		
	0.125 (3.2)	E51KE8A3	E51KE4A3
 Right Angle Viewing, Threaded Cable End	<b>Right Angle Viewing, Threaded Cable End</b>		
	0.125 (3.2)	E51KE8B3	E51KE4B3

Dimensions, see Page V8-T5-25.

#### Plastic Fiber Optic Cables

##### Plastic Fiber Optic Cables—Pre-Assembled Duplex Cables



Sensing Tip Style	Fiber Diameter in In (mm)	Catalog Number
 Large Diameter, Threaded Tip	<b>Large Diameter, Threaded Tip</b>	
	0.059 (1.5)	6324E-6501 <sup>①②</sup>
 Large Diameter, Threaded Tip with Bendable Probe	<b>Large Diameter, Threaded Tip with Bendable Probe</b>	
	0.039 (1.0)	6324E-6502 <sup>②</sup>

Dimensions, see Page V8-T5-25.

#### Notes

- ① Larger diameter (1.5 mm) fibers provide approximately 50% longer sensing range than small diameter (1 mm).
- ② One cable.
- ③ Set of two.



##### Plastic Fiber Optic Cables—Pre-Assembled Single Cables

Sensing Tip Style	Fiber Diameter in In (mm)	Catalog Number
 Large Diameter, Threaded Tip	<b>Large Diameter, Threaded Tip</b>	
	0.059 (1.5)	6323E-6501 <sup>①③</sup>
 Large Diameter, Threaded Tip with Bendable Probe	<b>Large Diameter, Threaded Tip with Bendable Probe</b>	
	0.039 (1.0)	6323E-6502 <sup>③</sup>

Dimensions, see Page V8-T5-25.

Accessories

Enhanced 50 Series Sensors

	Description	Catalog Number
 <p><b>Mounting Bracket Right Angle—Short</b></p>	<p><b>Mounting Bracket Right Angle—Short</b></p> <p>Provides for full 360° rotation of sensor. Bracket slots allow for up to 1.5 in of vertical adjustment. Nickel plated</p>	<b>6150E-6501</b>
	<p><b>Mounting Bracket Right Angle—Tall</b></p> <p>Provides for full 360° rotation of sensor. Bracket slots allow for up to 1.5 in of vertical adjustment in each slot, and 3.5 in of overall positioning adjustment.</p>	<b>6150E-6502</b>
 <p><b>Mounting Bracket Right Angle—Ball Swivel</b></p>	<p><b>Mounting Bracket Right Angle—Ball Swivel</b></p> <p>Provides for full 360° rotation of sensor. Ball swivel allows for ±30° sensor angle.</p>	<b>6150E-6503</b>
	<p><b>Retroreflectors</b></p> <p>Retroreflectors and retroreflective tape, see <b>Tab 8, section 8.1</b></p>	—
<p><b>Connector Cables</b></p> <p>For use with connector version sensors, see <b>Tab 10, section 10.1</b></p>	—	
<p><b>Dimensions, see Page V8-T5-25.</b></p>		

Technical Data and Specifications

Enhanced 50 Series Sensors

Description	AC/DC EM Relay Model Specification	AC/DC Solid-state Relay Model Specification	DC Only Standard Range Model Specification	DC Only Extended Range Model Specification
Input voltage	12–240 Vdc; 24–240 Vac	12–240 Vdc; 24–240 Vac	10–40 Vdc	10–40 Vdc
Light/dark operation	Switch selectable	Switch selectable	Switch selectable	Switch selectable
Operating temperature	–13° to 131°F (–25° to 55°C)	–13° to 131°F (–25° to 55°C)	–13° to 131°F (–25° to 55°C)	–13° to 131°F (–25° to 55°C)
Humidity	95% Relative humidity, non-condensing	95% Relative humidity, non-condensing	95% Relative humidity, non-condensing	95% Relative humidity, non-condensing
Case material	Fiberglass reinforced plastic	Fiberglass reinforced plastic	Fiberglass reinforced plastic	Fiberglass reinforced plastic
Lens material	Acrylic	Acrylic	Acrylic	Acrylic
Vibration	IEC 60947-5-2 part 7.4.2	IEC 60947-5-2 part 7.4.2	IEC 60947-5-2 part 7.4.2	IEC 60947-5-2 part 7.4.2
Shock	IEC 60947-5-2 part 7.4.1	IEC 60947-5-2 part 7.4.1	IEC 60947-5-2 part 7.4.1	IEC 60947-5-2 part 7.4.1
Protection	—	Output short circuit and overcurrent protection Reverse polarity protection	Output short circuit and overcurrent protection Reverse polarity protection	Output short circuit and overcurrent protection Reverse polarity protection
Enclosure ratings	IP67, IP69	IP67, IP69	IP67, IP69	IP67, IP69
Output load	3A at 120 Vac; 3A at 240 Vac 3A at 28 Vac	300 mA at 240 Vac/dc	250 mA at 40 Vdc	250 mA at 40 Vdc
Response time	15 ms	2 ms	2 ms	2 ms
Timer timing response	0–15 sec.	0–15 sec.	0–15 sec.	0–15 sec.
No load current	<30 mA	<30 mA	<30 mA	<30 mA
Leakage current (max.)	—	1 mA at 240 Vac	<10 µA	<10 µA
Indicator LEDs	Green: output; yellow: power; red: alignment	Green: output; yellow: power; red: alignment	Green: output; yellow: power; red: alignment	Green: output; yellow: power; red: alignment
Emitter LED				
Diffuse, infrared fiber optic, thru-beam models	Infrared 880 mm	Infrared 880 mm	Infrared 880 mm	Infrared 880 mm
Reflex, polarized reflex, clear object, visible fiber optic units	Visible red 660 mm	Visible red 660 mm	Visible red 660 mm	Visible red 660 mm

# 5.1

## Photoelectric Sensors

### Enhanced 50 Series Sensors

5

#### Excess Gain

##### Thru-Beam

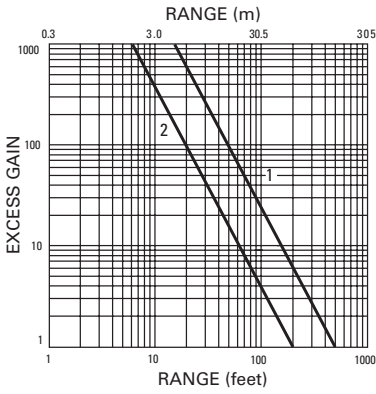

Thru-beam  
 1. 1151E/1251E  
 2. 1150E/1250E

##### Clear Object Detector

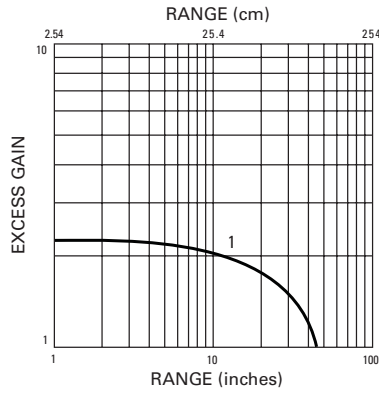

Clear object detector  
 3 in retroreflector  
 1. 1452E

##### Diffuse Reflective

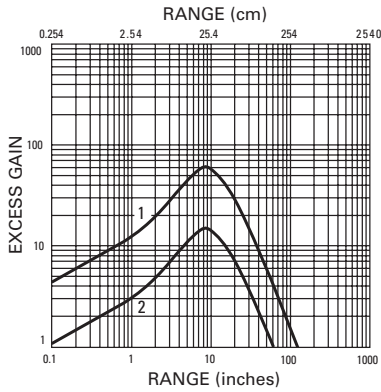

Diffuse reflective  
 90% reflectance white card  
 1. 1351E  
 2. 1350E

##### Fiber Optic Diffuse

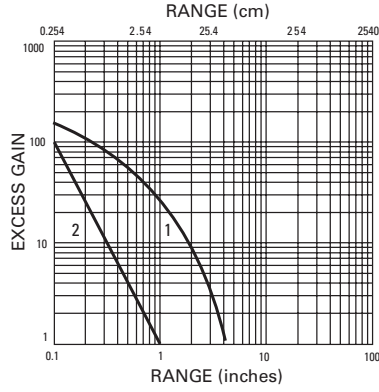

Fiber optic diffuse  
 0.125 in dia. glass fiber      0.040 in dia. plastic fiber  
 1. 1550E      2. 1551E

##### Reflex

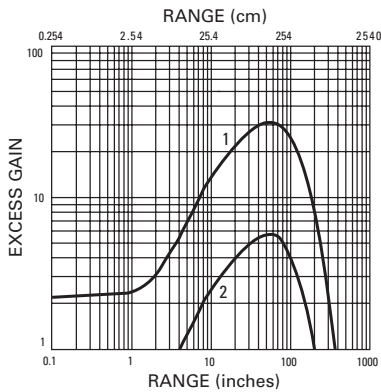

Reflex  
 3 in retroreflector  
 1. 1450E  
 2. 1451E

##### Fiber Optic Thru-Beam

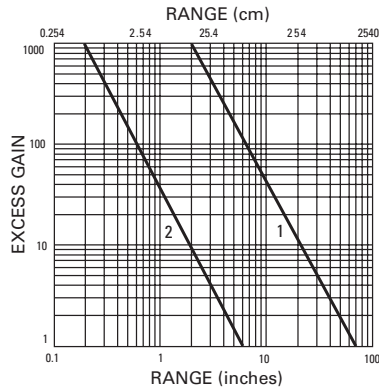

Fiber optic thru-beam  
 0.125 in dia. glass fiber      0.040 in dia. plastic fiber  
 1. 1550E      2. 1551E

### Wiring Diagrams

Pin numbers are for reference, rely on pin location when wiring.

#### Enhanced 50 Series Sensors

Operating Voltage	Cable Model	Mini-Connector Model (Face View Male Shown)	Micro-Connector Model (Face View Male Shown)
<b>Thru-Beam Source</b> 10–40 Vdc			
<b>All Others</b> 10–40 Vdc			
<b>Thru-Beam Source</b> 12–240 Vdc or 24–240 Vac			
<b>All Others with Isolated AC/DC Output</b> 12–240 Vdc or 24–240 Vac			
<b>Thru-Beam Source</b> 12–240 Vdc or 24–240 Vac			
<b>All Others</b> 12–240 Vdc or 24–240 Vac SPDT EM relay <sup>②</sup>			

#### Notes

- ① Connecting the test input to 0 Vdc allows you to switch the light source off for troubleshooting while leaving the sensor under power.
- ② Over current protection is to be provided in the field. Conductor size for 20 AWG: 5 amp; 22 AWG: 3 amp; 24 AWG: 2 amp.
- ③ Connect load to appropriate output for either sinking or sourcing operation.



# 5.1

## Photoelectric Sensors

### Enhanced 50 Series Sensors

#### Dimensions

Approximate dimensions in inches (mm)

#### Enhanced 50 Series Sensors

##### Cable and Pigtail Connector Versions

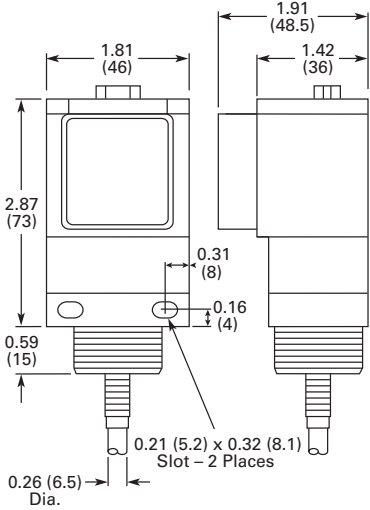

##### Mini-Connector Versions

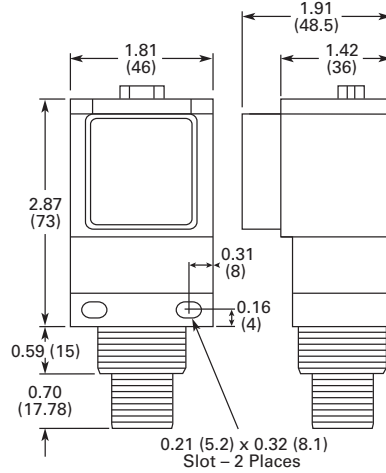

##### Clear Object Versions

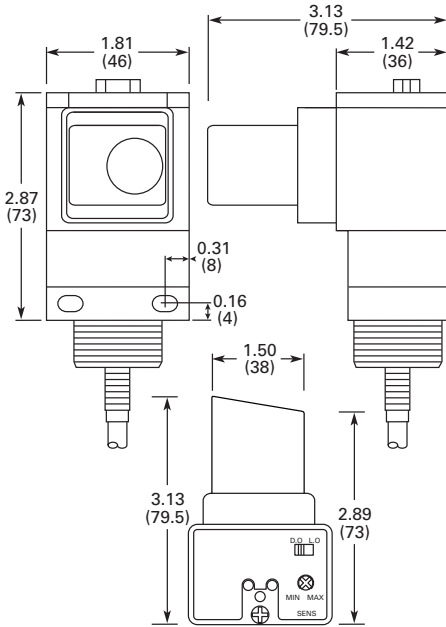

##### AC/DC Micro or Euro (Micro) Connector Versions

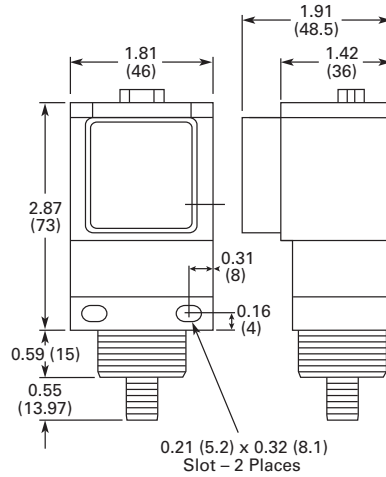

#### Top Views

##### With Timing

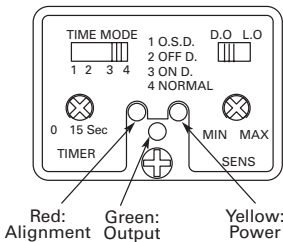

##### Without Timing

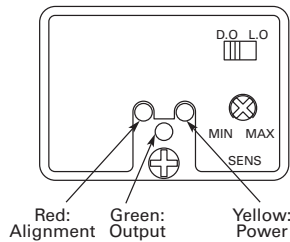

Approximate dimensions in inches (mm)

### Glass Fiber Optic Cables—Duplex Cables

Stainless Steel Jacket shown for all.

#### Collar Mounting End

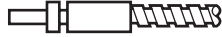

#### Forward Viewing, Unthreaded

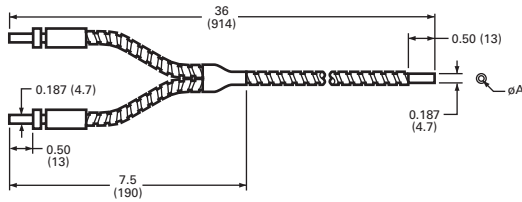

#### Right Angle Viewing, Unthreaded



#### Forward Viewing, Threaded Cable End

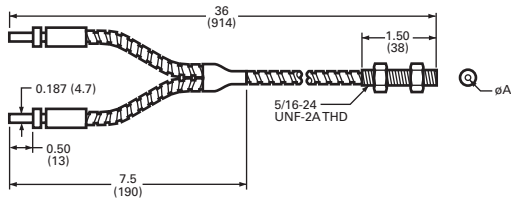

#### Right Angle Viewing, Threaded Cable Shaft

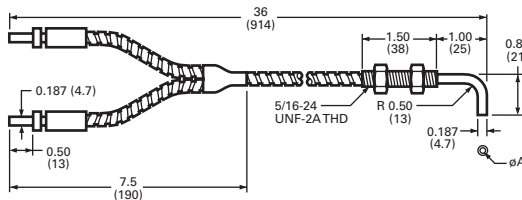

#### Right Angle Viewing, Threaded Cable End

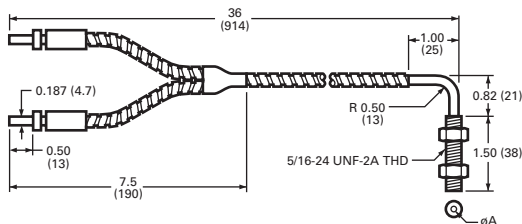

### Glass Fiber Optic Cables—Single Cables

Stainless Steel Jacket shown for all.

#### Collar Mounting End

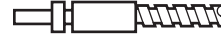

#### Forward Viewing, Unthreaded

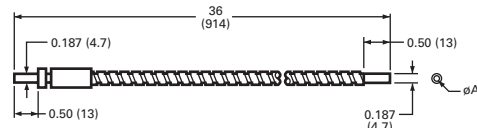

#### Right Angle Viewing, Unthreaded

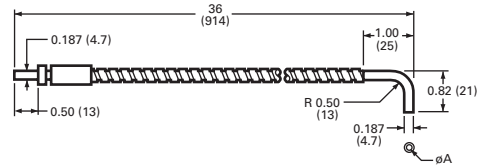

#### Forward Viewing, Threaded Cable End

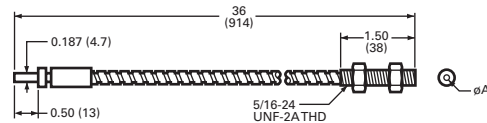

#### Right Angle Viewing, Threaded Cable Shaft

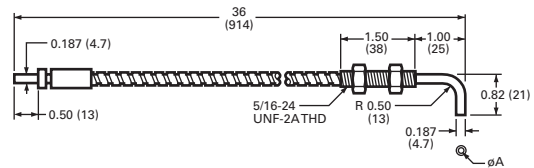

#### Right Angle Viewing, Threaded Cable End

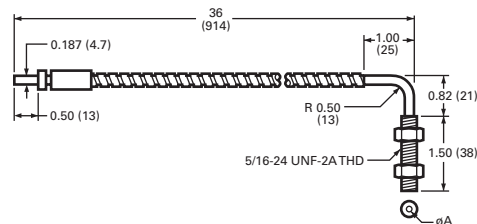

# 5.1

## Photoelectric Sensors

### Enhanced 50 Series Sensors

Approximate dimensions in inches (mm)

#### Plastic Fiber Optic Cables—Pre-Assembled Duplex Cables

##### Large Diameter, Threaded Tip

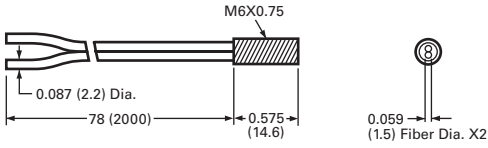

#### Plastic Fiber Optic Cables—Pre-Assembled Single Cables

##### Large Diameter, Threaded Tip

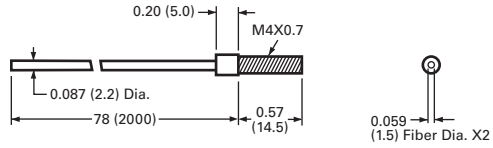

##### Large Diameter, Threaded Tip with Bendable Probe

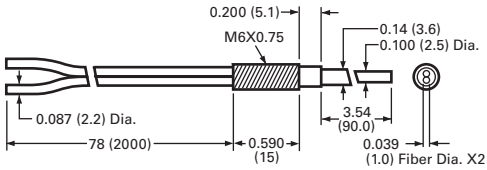

##### Large Diameter, Threaded Tip with Bendable Probe

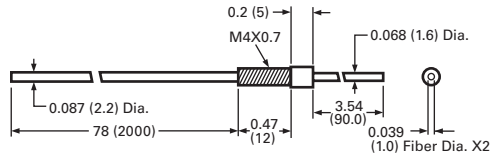

#### Accessories

##### Mounting Bracket Right Angle—Short

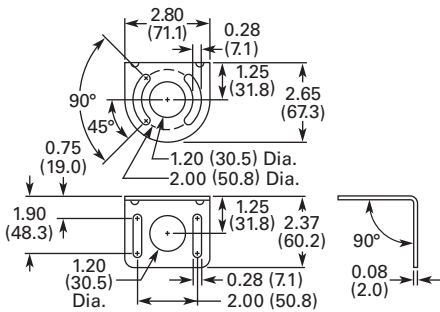

##### Mounting Bracket Right Angle—Ball Swivel

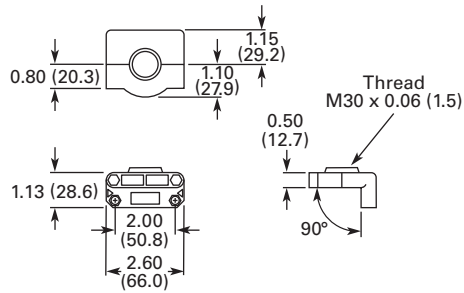

##### Mounting Bracket Right Angle—Tall

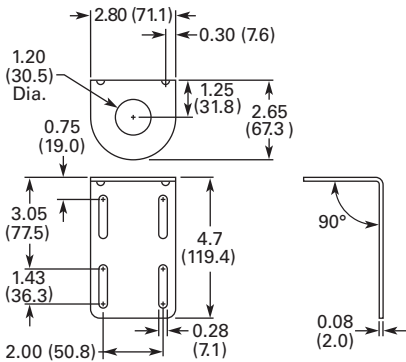

NanoView Series Sensors



Contents

<b>Description</b>	<b>Page</b>
NanoView Series Sensors	
Product Selection	
NanoView Series Sensors—	
Four-Wire Sensors . . . . .	<b>V8-T5-28</b>
Compatible Connector Cables . . . . .	<b>V8-T5-29</b>
Accessories . . . . .	<b>V8-T5-29</b>
Technical Data and Specifications . . . . .	<b>V8-T5-30</b>
Detection Diagrams . . . . .	<b>V8-T5-30</b>
Wiring Diagrams . . . . .	<b>V8-T5-31</b>
Dimensions . . . . .	<b>V8-T5-32</b>

**NanoView Series Sensors**

**Product Description**

The NanoView™ Series from Eaton is a family of miniature rectangular photoelectric sensors designed for optimum value and sensing performance in a wide range of applications.

These small sensors are available in a variety of optical modes: polarized reflex; diffuse reflective; fixed-focus diffuse; thru-beam with narrow-beam option; and even a clear object detector.

NanoView sensors are housed in ABS enclosures rated IP66 or better. Two top-mounted indicator LEDs communicate power and output status. Each model includes both light operate and dark operate modes. Termination options include a 4-pin M8 connector cable or a built-in 6 ft (2 m) cable.

NanoView is the ultimate solution to sensing challenges that require reduced dimensions and costs.

**Features**

- A complete family of solutions—Models include an 8.2 ft (2.5 m) polarized reflex, a 13 in (35 cm) diffuse reflective, a 4 in (10 cm) fixed-focus diffuse, a 20 ft (6 m) thru-beam; and a 2.6 ft (80 cm) clear object detector for sensing plastic bottles, molds, cartons and films
- Small size—At less than 1.5 in long and half an in deep, NanoView can fit into the smallest of spaces
- Fixed focus diffuse models—Perfect for sensing very small targets at a 4-in focal point. A visible red LED beam makes it easy to set up
- Clear object detection models—Ideal for sensing plastic bottles, molds, cartons, films and glass objects

**Standards and Certifications**

- UL Listed, E166051
- UL tested to Canadian safety standards
- CE
- RoHS Compliant



**⚠ DANGER**

**THIS SENSOR IS NOT A SAFETY DEVICE AND IS NOT INTENDED TO BE USED AS A SAFETY DEVICE. This sensor is designed only to detect and read certain data in an electronic manner and perform no use apart from that, specifically no safety-related use. This sensor product does not include self-checking redundant circuitry, and the failure of this sensor product could cause either an energized or de-energized output condition, which could result in death, serious bodily injury, or property damage.**

For the most current information on this product, visit our Web site: [www.eaton.com](http://www.eaton.com)

For Customer Service in the U.S. call 1-877-ETN CARE (386-2273), in Canada call 1-800-268-3578. For Application Assistance in the U.S. and Canada call 1-800-426-9184.

## Product Selection



## NanoView Series Sensors—Four-Wire Sensors

	Voltage Range	Sensing Mode	Sensing Range	Output Type	Connection Type	Catalog Number				
<b>Thru-Beam</b> 	10–30 Vdc	Thru-beam detector	19 ft (6 m)	NPN, light operate or dark operate (selectable)	6 ft cable	<b>E71-TBRN-CA</b>				
					4-pin nano-connector ①	<b>E71-TBRN-M8</b>				
				PNP, light operate or dark operate (selectable)	6 ft cable	<b>E71-TBRP-CA</b>				
					4-pin nano-connector ①	<b>E71-TBRP-M8</b>				
		Thru-beam source	19 ft (6 m)	N/A	6 ft cable	<b>E71-TBS-CA</b>				
					4-pin nano-connector ①	<b>E71-TBS-M8</b>				
Narrow beam Thru-beam source	4.9 ft (1.5 m)	N/A	6 ft cable	<b>E71-NTBS-CA</b>						
			4-pin nano-connector ①	<b>E71-NTBS-M8</b>						
<b>Polarized Reflex</b> 	10–30 Vdc	Polarized reflex	8.2 ft (2.5 m)	NPN, light operate or dark operate (selectable)	6 ft cable	<b>E71-PRN-CA</b>				
					4-pin nano-connector ①	<b>E71-PRN-M8</b>				
					PNP, light operate or dark operate (selectable)	6 ft cable	<b>E71-PRP-CA</b>			
						4-pin nano-connector ①	<b>E71-PRP-M8</b>			
				<b>Diffuse Reflective</b> 	10–30 Vdc	Diffuse reflective	13.8 in (35 cm)	NPN, light operate or dark operate (selectable)	6 ft cable	<b>E71-SDN-CA</b>
									4-pin nano-connector ①	<b>E71-SDN-M8</b>
PNP, light operate or dark operate (selectable)	6 ft cable	<b>E71-SDP-CA</b>								
	4-pin nano-connector ①	<b>E71-SDP-M8</b>								
<b>Fixed Focus Diffuse Reflective</b> 	10–30 Vdc	Fixed-focus Diffuse reflective	3.9 in (10 cm) focal point					NPN, light operate or dark operate (selectable)	6 ft cable	<b>E71-FFDN-CA</b>
									4-pin nano-connector ①	<b>E71-FFDN-M8</b>
				PNP, light operate or dark operate (selectable)	6 ft cable	<b>E71-FFDP-CA</b>				
					4-pin nano-connector ①	<b>E71-FFDP-M8</b>				
				<b>Clear Object Detector</b> 	10–30 Vdc	Clear object detector	31.5 in (80 cm)	NPN, light operate or dark operate (selectable)	6 ft cable	<b>E71-CON-CA</b>
									4-pin nano-connector ①	<b>E71-CON-M8</b>
PNP, light operate or dark operate (selectable)	6 ft cable	<b>E71-COP-CA</b>								
	4-pin nano-connector ①	<b>E71-COP-M8</b>								

**Note**① For compatible connector cables, see [Page V8-T5-29](#).

**Compatible Connector Cables**

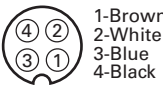
**Standard Cables—Nano** <sup>①</sup>

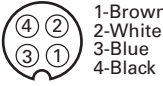
	Voltage Style	Number of Pins	Gauge	Length	Pin Configuration/Wire Colors (Face View Female Shown)	PVC Yellow Jacket Catalog Number
<b>M8 Nano-Connector, Straight Female</b> 	<b>Nano-Connector Cable, Straight Female</b>					
	DC	4-pin, 4-wire	24 AWG	6 ft (2 m)		<b>CSNS4A4CY2402</b>
				16.4 ft (5 m)		<b>CSNS4A4CY2405</b>
			32.8 ft (10 m)	<b>CSNS4A4CY2410</b>		
<b>M8 Nano-Connector, Right Angle Female</b> 	<b>Nano-Connector Cable, Right Angle Female</b>					
	DC	4-pin, 4-wire	24 AWG	6 ft (2 m)		<b>CSNR4A4CY2402</b>
				16.4 ft (5 m)		<b>CSNR4A4CY2405</b>
			32.8 ft (10 m)	<b>CSNR4A4CY2410</b>		

**Accessories**

**NanoView Series Sensors**

	Description	Catalog Number
<b>Mounting Bracket</b> 	<b>Mounting Bracket</b>	
	L-shaped mounting bracket for NanoView sensors	<b>E71-MTB1</b>

**Dimensions**, see **Page V8-T5-32**.

**Note**

<sup>①</sup> For a full selection of connector cables, see **Tab 10, section 10.1**.

#### Technical Data and Specifications

##### NanoView Series Sensors

Description	For E71-T/N (Thru-Beam) Specification	For E71-P (Polarized Reflex) Specification	For E71-S (Diffuse Reflective) Specification	For E71-F (Fixed Focus Diffuse) Specification	For E71-C (Clear Object Detector) Specification
Input voltage	10–30 Vdc	10–30 Vdc	10–30 Vdc	10–30 Vdc	10–30 Vdc
Current consumption (Output current excluded)	35 mA max.	35 mA max.	35 mA max.	35 mA max.	35 mA max.
Outputs	Light operate and dark operate; PNP or NPN by model; 30 Vdc max.	Light operate and dark operate; PNP or NPN by model; 30 Vdc max.	Light operate and dark operate; PNP or NPN by model; 30 Vdc max.	Light operate and dark operate; PNP or NPN by model; 30 Vdc max.	Light operate and dark operate; PNP or NPN by model; 30 Vdc max.
Output current	100 mA max.	100 mA max.	100 mA max.	100 mA max.	100 mA max.
Output saturation voltage	2V max.	2V max.	2V max.	2V max.	2V max.
Electrical protection	Short circuit and reverse polarity protection	Short circuit and reverse polarity protection	Short circuit and reverse polarity protection	Short circuit and reverse polarity protection	Short circuit and reverse polarity protection
Response time	1 ms max.	1 ms max.	1 ms max.	1 ms max.	1 ms max.
Switching frequency	500 Hz max.	500 Hz max.	500 Hz max.	500 Hz max.	500 Hz max.
Indicator LEDs	Output LED (yellow), stability LED (green), power LED (green)	Output LED (yellow), stability LED (green), power LED (green)	Output LED (yellow), stability LED (green), power LED (green)	Output LED (yellow), stability LED (green), power LED (green)	Output LED (yellow), stability LED (green), power LED (green)
Sensing adjustment	None	Adjustment pot	Adjustment pot	None	Adjustment pot
Temperature range					
Operating	–25° to 55°C (–13° to 131°F)	–25° to 55°C (–13° to 131°F)	–25° to 55°C (–13° to 131°F)	–25° to 55°C (–13° to 131°F)	–25° to 55°C (–13° to 131°F)
Storage	–25° to 70°C (–13° to 158°F)	–25° to 70°C (–13° to 158°F)	–25° to 70°C (–13° to 158°F)	–25° to 70°C (–13° to 158°F)	–25° to 70°C (–13° to 158°F)
Sensing range	Standard beam: 19.7 ft (6.0 m) Narrow beam: 4.9 ft (1.5 m)	8.2 ft (2.5 m)	13.8 in (35 cm)	3.9 in (10 cm)	31.5 in (80 cm)
Beam type	Infrared LED (880 nm)	Visible red LED (660 nm)	Infrared LED (880 nm)	Visible red LED (660 nm)	Visible red LED (660 nm)
Vibration and shock	Vibration: 0.5 mm amplitude, 10–55 Hz for every axis (EN60068-2-6); Half sine, 30 g <sub>n</sub> , 11 ms, 3 axes	Vibration: 0.5 mm amplitude, 10–55 Hz for every axis (EN60068-2-6); Half sine, 30 g <sub>n</sub> , 11 ms, 3 axes	Vibration: 0.5 mm amplitude, 10–55 Hz for every axis (EN60068-2-6); Half sine, 30 g <sub>n</sub> , 11 ms, 3 axes	Vibration: 0.5 mm amplitude, 10–55 Hz for every axis (EN60068-2-6); Half sine, 30 g <sub>n</sub> , 11 ms, 3 axes	Vibration: 0.5 mm amplitude, 10–55 Hz for every axis (EN60068-2-6); Half sine, 30 g <sub>n</sub> , 11 ms, 3 axes
Housing material	ABS UL 94V-0	ABS UL 94V-0	ABS UL 94V-0	ABS UL 94V-0	ABS UL 94V-0
Lens material	PMMA	PMMA	PMMA	PMMA	PMMA
Mechanical protection	IP67	IP66	IP66	IP67	IP66
Connections	M8 4-pin nano-connector; 6 ft (2 m) cable	M8 4-pin nano-connector; 6 ft (2 m) cable	M8 4-pin nano-connector; 6 ft (2 m) cable	M8 4-pin nano-connector; 6 ft (2 m) cable	M8 4-pin nano-connector; 6 ft (2 m) cable
Weight	Connector models: 40g max. Cable models: 10g max.	Connector models: 40g max. Cable models: 10g max.	Connector models: 40g max. Cable models: 10g max.	Connector models: 40g max. Cable models: 10g max.	Connector models: 40g max. Cable models: 10g max.

#### Detection Diagrams

##### Thru-Beam Models

###### E71-N

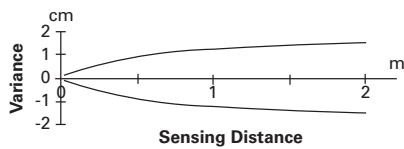

###### E71-T

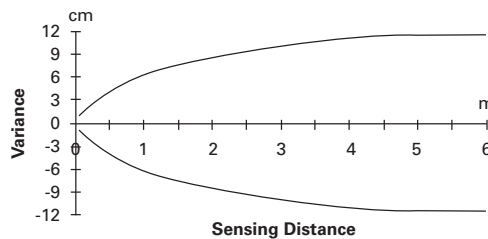

### Polarized Reflex Models

#### E71-P

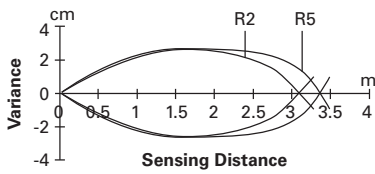

### Fixed Focus Diffuse Models

#### E71-F ①

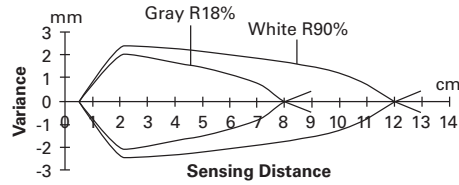

### Diffuse Reflective Models

#### E71-S ①

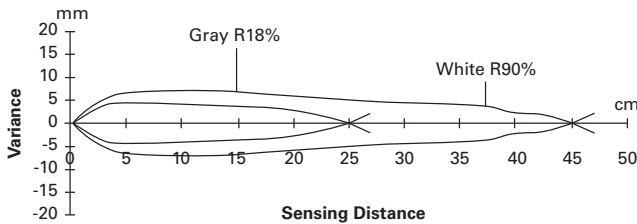

### Clear Object Detector Models

#### E71-C

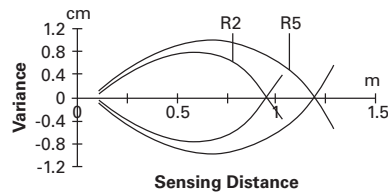

### Wiring Diagrams

Pin numbers are for reference, rely on pin location when wiring.

### NanoView Series Sensors

Model	Nano-Connector Diagram (Face View Male Shown)	Cable Diagram
All NPN models except thru-beam source		
All PNP models except thru-beam source		
All thru-beam source models		

#### Note

① These diagrams depict the width of the sensing beam over distance. These diagrams also show the sensing difference between white and gray targets. Because gray is less reflective than white, gray targets will typically need to come closer to the beam centerpoint to be detected.



# 5.2

## Photoelectric Sensors

### NanoView Series Sensors

#### Dimensions

Approximate dimensions in inches (mm)

#### Cable Models

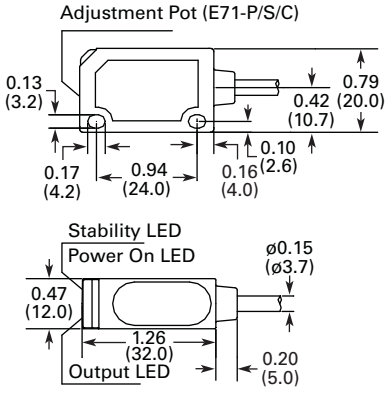

#### Nano-Connector Models

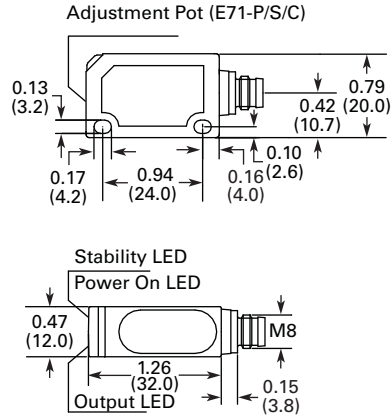

#### Accessories

#### E71-MTB1—Mounting Bracket

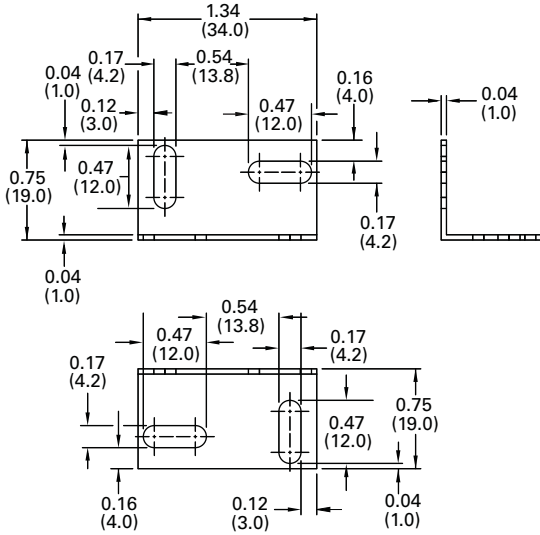

### IntelliView Series Sensors



## Contents

<b>Description</b>	<b>Page</b>
IntelliView Series Sensors	
Product Selection	
Foreground/Background Sensing . . . . .	<b>V8-T5-34</b>
Distance Sensing . . . . .	<b>V8-T5-35</b>
Color, Contrast and Luminescence Sensing . . . . .	<b>V8-T5-37</b>
Compatible Connector Cables . . . . .	<b>V8-T5-38</b>
Accessories . . . . .	<b>V8-T5-38</b>
Technical Data and Specifications . . . . .	<b>V8-T5-39</b>
Detection Diagrams . . . . .	<b>V8-T5-42</b>
Wiring Diagrams . . . . .	<b>V8-T5-43</b>
Dimensions . . . . .	<b>V8-T5-44</b>

## IntelliView Series Sensors

### Product Description

The IntelliView™ Series from Eaton is a family of compact, high performance specialty photoelectric sensors designed to solve a wide array of sensing challenges.

IntelliView encompasses a variety of new sensing technologies: color, contrast and luminescence sensing; field-adjustable foreground and background suppression sensing; and long-range, high-precision laser distance sensing with analog outputs.

To fit into your application, IntelliView sensors are available in industry-standard M18 flat-tubular and compact rectangular package sizes. For ease of installation and replacement, all models are available with micro-connectors.

### Features

- New sensing technologies—Eaton has solutions for sensing color, contrast, luminescence and distance with great accuracy
- Small size, big solutions—IntelliView sensors come in either compact rectangular or flat-tubular package sizes, with rugged sealed enclosures
- Simple “teach in” installation—Most models include a teach mode, allowing for quick and simple installation and setup
- Adjustable background suppression—Eaton offers a fully field-adjustable background suppression photoelectric sensor capable of detecting targets as far as 3.9 ft (1.9 m) away
- LED indicators and pushbuttons—Multiple LEDs communicate output and power status while built-in pushbuttons and adjustment potentiometers simplify the teaching of sensor settings

### Standards and Certifications

- UL Listed, E166051
- UL tested to Canadian safety standards
- CE
- RoHS Compliant



**⚠ DANGER**  
**THIS SENSOR IS NOT A SAFETY DEVICE AND IS NOT INTENDED TO BE USED AS A SAFETY DEVICE. This sensor is designed only to detect and read certain data in an electronic manner and perform no use apart from that, specifically no safety-related use. This sensor product does not include self-checking redundant circuitry, and the failure of this sensor product could cause either an energized or de-energized output condition, which could result in death, serious bodily injury, or property damage.**

For the most current information on this product, visit our Web site: [www.eaton.com](http://www.eaton.com)

For Customer Service in the U.S. call 1-877-ETN CARE (386-2273), in Canada call 1-800-268-3578.  
 For Application Assistance in the U.S. and Canada call 1-800-426-9184.

# 5.3

## Photoelectric Sensors

### IntelliView Series Sensors

#### Product Selection

##### Overview—Foreground/Background Sensing



5

#### Adjustable Foreground/Background Suppression Models



- Ignores nuisance foreground or background objects
- Field-adjustable sensing ranges
- Compact 50x50 mm rectangular package size
- M12 micro-connector termination with 90- and 180-degree rotation options
- Sensing ranges up to 47.2 in (120 cm)

#### Foreground/Background Sensing Basics

Foreground/background suppression sensors allow the user to precisely set the minimum and maximum detection distance. This allows detection of a target only when it is inside a given area, avoiding the interference of objects lying before (foreground) and behind (background). This type of sensor is ideal for suppressing the detection of box edges and bottoms, sending an output only upon the presence of goods actually contained in the box.

#### Foreground/Background Sensing

##### Adjustable Foreground/Background Suppression

	Voltage Range	Output Type	Connection	Adjustable Sensing Range	Catalog Number
<b>Compact Rectangular (50 x 50 x 18 mm)</b> 	<b>Background Suppression Models</b>				
	10–30 Vdc	Light operate or dark operate (selectable), PNP	4-pin micro-connector ①	3–10 cm (1.2–4.0 in)	<b>E75-PPA010P-M12</b> ②
				3–25 cm (1.2–9.8 in)	<b>E75-PPA025P-M12</b>
				10–50 cm (4.0–19.7 in)	<b>E75-PPA050P-M12</b>
<b>Compact Rectangular (50 x 50 x 18 mm)</b> 	<b>Extended Range Background Suppression Models</b>				
	10–30 Vdc	Light operate or dark operate (selectable), PNP	4-pin micro-connector ①	6–120 cm (2.4–47.2 in)	<b>E75-PP1MP-M12</b>
<b>Compact Rectangular (50 x 50 x 18 mm)</b> 	<b>Foreground/Background Suppression Models</b>				
	10–30 Vdc	Light operate or dark operate (selectable), PNP	4-pin micro-connector ①	Foreground: 5–20 cm (2.0–7.9 in) Background: 12–110 cm (4.7–43.3 in)	<b>E75-PPA110P-M12</b>

#### Notes

- ① For compatible connector cables, see **Page V8-T5-38**.
- ② Range not adjustable.

**Overview—Distance Sensing Models with Analog Outputs**



**Long-Range, High-Precision Laser Distance Measurement Sensor**

**Distance Sensing Models with Analog Outputs**

- When within the effective range of the sensor, outputs a 0–10V signal proportional to the target’s distance from the sensor face
- Class II laser emitter detects objects from 0.3 to 4m (1 to 13.1 ft) away
- Two additional PNP outputs can be programmed to switch at predetermined ranges
- Simple three-step teach routine to program range cutoffs
- Unmatched accuracy and resolution at long sensing distances
- When within the effective range of the sensor, outputs a 0–10V signal proportional to the target’s distance from the sensor face
- Visible red LED emitter detects objects from 5 to 10 cm (1.9 to 3.9 in)
- Two indicator LEDs communicate sensor status: a yellow LED with light intensity proportional to the target’s distance within the sensor’s range, and a red LED that activates when the target is beyond maximum sensing range
- Flat tubular package can be mounted using the body threads or flat against a surface

**Distance Sensing Explained**

Distance sensors output a 0–10V analog signal in proportion to the measurement of the distance between the sensor and target. Optical triangulation, a technology similar to that used in Eaton’s Perfect Prox or diffuse sensors, is used for short- to mid-range distance sensing applications that do not require a high degree of accuracy. Time-of-flight technology, a method of measuring the time it takes for the emitted beam to bounce off the target and return to the detector, is used for longer range distance sensing applications. Time-of-flight is highly accurate with precise resolution over long sensing distances.

**Distance Sensing**

**Distance Sensing Models with Analog Outputs**

Voltage Range	Output Type	Connection	Adjustable Sensing Range	Catalog Number
<b>Rectangular (80 x 53 x 31 mm)</b>				
<b>Long-Range Laser Distance Sensor with Time-of-Flight Technology</b>				
19–28 Vdc	Analog output (0–10V), dual teachable PNP outputs, Light operate mode	5-pin micro-connector <sup>①</sup>	0.3–4.0m (1.0–13.1 ft)	<b>E75-DST400A010-M12</b> <sup>②</sup>



**Notes**

- <sup>①</sup> For compatible connector cables, see **Page V8-T5-38**.
- <sup>②</sup> This sensor is a Class II laser device. Eye irradiation for over 0.25 seconds is dangerous. Refer to the Class II Standard (EN60825-1) for additional safety information.

**Overview—Color and Contrast Sensing Models**

5

**Color Sensors**

- Can be programmed to recognize three different colors independently
- Capable of sensing targets 5–45 mm away from the sensor face
- Rectangular plastic package features a four-digit display, two programming buttons and output status LEDs
- Optional serial connection (RS485) allows for remote communications
- Standard M12 8-pin micro-connector (mating cable available on **Page V8-T5-28**)

**Contrast Sensors**

- Ideal for detecting different colored or grayscale contrasts, such as registration marks
- Capable of sensing targets out to 10 mm from the sensor face
- Simple three-step setup routine for quick installation or optional “fine setup routine” for more complicated applications
- Complementary outputs can function in either light operate or dark operate modes
- Standard M12 4-pin micro-connector (mating cable available on **Page V8-T5-29**)

**Color Sensing Basics**

Color sensors work by using a “chromaticity” detection algorithm. Chromaticity is determined by two characteristics: hue and saturation. Hue is determined by the reflected light’s wavelength, while saturation indicates the pureness percentage (with white representing 0%). Eaton’s color sensor goes one step further and provides an optional “chromaticity plus intensity” algorithm. This mode provides a higher sensitivity to tone variations and is recommended for detection of different colors on the same type of material. It will also better distinguishes between gray tones.

The color of a target is determined by the color components of the reflected source light. The target color is identified by analyzing the red (R), green (G) and blue (B) channels of reflected light. For example, yellow can be identified by the following reflections: R=50%, G=50%, B=0%; orange can be identified by R=75%, G=25%, B=0%; pink by R=50%, G=0%, B=0%. The RGB combinations are practically limitless. Applications for color sensors are common in many industries, ranging from quality and process control, to automatic material handling for identification, to orientation and selection of objects according to their color.

**Contrast Sensing Basics**

Contrast sensors (also defined as color mark readers, according to their most popular application) go beyond simple presence/absence detection to distinguish two surfaces according to the contrast produced by their difference in reflectivity. For example, a dark reference mark (low reflectivity) can be detected by comparing it against the contrast of the lighter surface (high reflectivity). A white LED light source is used for general purpose contrast sensing, enabling detection of the very slightest of contrast variations—even those that share the same general material and color. Contrast sensors are frequently used in automated packaging applications for registration mark detection to automate the folding, cutting and sorting phases.

**Overview—Luminescence Sensing Models**



**Luminescence Sensors**



- Perfect for the detection of any luminescent target, even on reflective materials such as ceramics, metal or mirrored glass
- Capable of sensing from 8–20 mm from the sensor face
- Simple three-step setup routine and optional “fine setup routine” for more complicated applications
- Can function in either light operate or dark operate mode
- Standard M12 4-pin micro-connector (mating cable available on **Page V8-T5-30**)

**Luminescence Sensing Basics**

Luminescence is defined as visible light emission from fluorescent or phosphorescent substances. Luminescence sensors emit ultraviolet light, which is then reflected at a higher wavelength from the target surface. The UV emission from the sensor is modulated and the visible light received is synchronized, resulting in immunity against external interferences such as reflections caused by shiny objects. Luminescence sensors are used in various industries to detect labels, fluorescent marks or signs, fluorescent glues on paper, to distinguish cutting and sewing guides, and to check fluorescent paints or lubricants.

**Color, Contrast and Luminescence Sensing**

**Color, Contrast and Luminescence Sensing Models**

	<b>Voltage Range</b>	<b>Sensing Range</b>	<b>Connection</b> ①	<b>Output Type</b>	<b>Catalog Number</b>
<b>Rectangular (50 x 50 x 25 mm)</b> 	10–30 Vdc	5–45 mm (0.19–1.77 in) ②	8-pin micro-connector ①	3 NO PNP outputs	<b>E76-CLRMKP-M12</b>
				3 NO NPN outputs	<b>E76-CLRMKN-M12</b>
				3 NO NPN outputs, RS485 connection ③	<b>E76-CLRMKRS-M12</b>
<b>Flat Tubular (18 mm)</b> 	10–30 Vdc	10 mm (0.39 in) ideal	4-pin micro-connector	Light operate or dark operate, PNP output	<b>E76-CNT010P-M12</b>
				Light operate or dark operate, NPN output	<b>E76-CNT010N-M12</b>
<b>Flat Tubular (18 mm)</b> 	10–30 Vdc	8–20 mm (0.31–0.79 in)	4-pin micro-connector	Light operate or dark operate, PNP output	<b>E76-UV020P-M12</b>

**Notes**

- ① For complete connector cables, see **Page V8-T5-38**.
- ② Refer to Detection Diagram on **Page V8-T5-43**.
- ③ Sensing parameters may be adjusted using the RS485 serial interface. The RGB color data is not available through this serial link.

# 5.3

## Photoelectric Sensors

### IntelliView Series Sensors

#### Compatible Connector Cables

M12 Micro-Connector, Straight Female



#### Standard Cables ①

Voltage Style	Number of Pins	Gauge	Length	Pin Configuration/Wire Colors (Face View Female Shown)	PVC Catalog Number	PUR Catalog Number	IRR PUR Catalog Number
<b>Micro-Connector, Straight Female</b>							
DC	4-pin, 4-wire	22 AWG	6 ft (2 m)		<b>CSDS4A4CY2202</b>	<b>CSDS4A4RY2202</b>	<b>CSDS4A4I02202</b>
			16.4 ft (5 m)		<b>CSDS4A4CY2205</b>	<b>CSDS4A4RY2205</b>	<b>CSDS4A4I02205</b>
			32.8 ft (10 m)		<b>CSDS4A4CY2210</b>	<b>CSDS4A4RY2210</b>	<b>CSDS4A4I02210</b>
	5-pin, 5-wire	22 AWG	6 ft (2 m)		<b>CSDS5A5CY2202</b>	—	—
			16.4 ft (5 m)		<b>CSDS5A5CY2205</b>	—	—
			32.8 ft (10 m)		<b>CSDS5A5CY2210</b>	—	—
	8-pin, 8-wire	24 AWG	6 ft (2 m)		<b>CSDS8A8CB2402</b>	—	—
			16.4 ft (5 m)		<b>CSDS8A8CB2405</b>	—	—
			32.8 ft (10 m)		<b>CSDS8A8CB2410</b>	—	—

5

#### Accessories

#### IntelliView Series Sensors

Mounting Brackets—L-Shaped



Description	Sensor Compatibility	Catalog Number
<b>Mounting Brackets—L-Shaped</b>		
L-shaped mounting bracket for IntelliView sensors Mounting hardware included	All models starting with E75-PPA_	<b>E75-MTB1</b>
Long L-shaped mounting bracket for IntelliView sensors Mounting hardware included	All models starting with E76-CLR_ and E75-PP1MP-M12	<b>E76-MTB1</b>
Adjustability: Allows some adjustment in one axis and allows for aiming of the sensor through a short arc Sensor mounting: Sensor mounts with two jam nuts and washers (included with sensor) Material of construction: Aluminum with chromate finish Packaging: Two per package	All 18 mm flat tubular sensors	<b>6161AS6501</b>

Mounting Bracket Ball Swivel



<b>Mounting Bracket Ball Swivel</b>		
Allows 360° rotation and 10° vertical tilt Hole spacing is identical to our 50 and 55 series sensors Ideal for mounting Right Angle sensors Made of Noryl®	All 18 mm flat tubular sensors	<b>6181AS5200</b>

#### Additional Mounting Brackets

More mounting brackets compatible with IntelliView sensors, see **Tab 8, section 8.2**

**Dimensions**, see **Page V8-T5-47**.

#### Note

① For a full selection of connector cables, see **Tab 10, section 10.1**.

## Technical Data and Specifications

### Foreground/Background Suppression Models

Description	Specification
Input voltage	10–30 Vdc
Ripple	2 Vpp max.
Outputs	PNP, NO or NC; 30 Vdc max.
Output current	100 mA max. (short-circuit protected)
Output saturation voltage	< 2V max.
Response time	1 ms
Switching frequency	500 Hz
Indicator LEDs	For E75-PPA: Output LED (red), stability LED (green) For E75-PP1: Output LED (yellow), stability LED (green)
Gain adjustment	For E75-PPA: Adjustment screw (except for E75-PPA010P) For E75-PP1: Six-turn adjustment pot with numerical indicator
Operating temperature	–25° to 55°C (–13° to 131°F)
Storage temperature	–25° to 70°C (–13° to 158°F)
Electrical protection	Class 2
Sensing distance	Varies by model, see model selection table on <b>Page V8-T5-37</b>
Beam type	All models except E75-PPA010P-M12: Infrared LED 880 nm E75-PPA010P-M12: Red LED
Vibration	Amplitude: 0.5 mm Frequency: 10–55 Hz for every axis (EN60068-2-6)
Shock resistance	Half sine, 30 g <sub>n</sub> , 11 ms, 3 axes
Housing material	ABS
Lens material	PMMA
Enclosure ratings	For E75-PPA_: IP65 For E75-PP1_: IP67
Connections	M12 4-pin micro-connector
Weight	40g max.

### Distance Sensing Models—Long Range

Description	For E75-DST4_ (Long-Range Distance Sensor) Specification
Input voltage	16–28 Vdc
Ripple	2 Vpp max.
Current consumption (Output current excluded)	120 mA max.
Outputs	Analog, 0–10V 2 PNP outputs 30 Vdc max.
Output switching mode	Light operate (output on when target present)
Output current	100 mA max. (short-circuit protected)
Output saturation voltage	< 2V max.
Response time	12 ms
Switching frequency	42 Hz
Indicator LEDs	2 output LEDs (yellow) Power/alarm LED (green)
Distance adjustment	Dual buttons
Warm-up	15 min
Operating temperature	0° to 50°C (32° to 122°F)
Storage temperature	–20° to 70°C (–4° to 158°F)
Measurement range	0.3–4.0m (1.0–13.1 ft)
Linearity	< 1% (24 Vdc, 25°C, with 90% white target)
Repeatability	± 4 mm
Hysteresis	20 mm
Temperature drift	< 1 mm per °C
Beam type	Red laser (665 nm), Class 2 EN 60825-1 (1994) A1 (2002) A2 (2001)
Vibration	Amplitude: 0.5 mm Frequency: 10–55 Hz for every axis (EN60068-2-6)
Shock resistance	Half sine, 30 g <sub>n</sub> , 11 ms, 3 axes
Material of construction	ABS
Lens material	PMMA
Enclosure ratings	IP67
Connections	M12 5-pin micro-connector
Weight	92g max.



## Color Sensing Models

Description	Specification
Input voltage	10–30 Vdc
Ripple	2V max.
Current consumption (Output current excluded)	60 mA max.
Outputs	3 PNP outputs 30 Vdc max. (short-circuit protected)
Output switching mode	100 mA max.
Output saturation voltage	< 2V
Response time	650 $\mu$ s
Switching frequency	770 Hz
Indicator LEDs	4-digit display (green), Output LED (yellow), 3 status LEDs (green)
Sensing adjustment	SET, SEL buttons
Operating temperature	–10° to 55°C (14° to 131°F)
Storage temperature	–20° to 70°C (–4° to 158°F)
Protection	Class 2
Sensing distance	20 mm (0.79 in)
Beam spot dimension	$\emptyset$ 4 mm
Beam type	White LED (400–700 nm)
Vibration	Amplitude: 0.5 mm Frequency: 10–55 Hz for every axis (EN60068-2-6)
Shock resistance	Half sine, 30 g <sub>n</sub> , 11 ms, 3 axes
Material of construction	ABS thermoplastic
Lens material	Glass window and lens
Mechanical protection	IP67
Connections	M12 8-pin micro-connector

**Contrast Sensing Models**

Description	Specification
Input voltage	10–30 Vdc
Ripple	2V max.
Current consumption (Output current excluded)	25 mA max.
Outputs	PNP or NPN by model, NO and NC, 30 Vcc max. (short-circuit protected)
Output current	100 mA max.
Output saturation voltage	< 2V
Response time	185 μs
Switching frequency	2.7 kHz
Indicator LEDs	Output LED (yellow) Ready/error LED (green/red)
Data retention	EEPROM non-volatile memory
Operating mode	Light operate on NO output Dark operate on NC output
Operating temperature	–10° to 55°C (14° to 131°F)
Storage temperature	–20° to 70°C (–4° to 158°F)
Operating distance	10 mm ± 2 mm
Beam type	White LED (400–700 nm)
Vibration	Amplitude: 0.5 mm Frequency: 10–55 Hz for every axis (EN60068-2-6)
Shock resistance	Half sine, 30 g <sub>n</sub> , 11 ms, 3 axes
Material of construction	PBT
Lens material	PMMA plastic
Enclosure ratings	IP67
Connections	M12 4-pin micro-connector cable
Weight	25g max.

**Luminescence Sensing Models**

Description	Specification
Input voltage	10–30 Vdc
Ripple	2V max.
Current consumption (Output current excluded)	25 mA max.
Outputs	PNP or NPN by model, NO and NC, 30 Vcc max. (short-circuit protected)
Output current	100 mA max.
Output saturation voltage	< 2V
Response time	1.1 ms
Switching frequency	445 Hz
Indicator LEDs	Output LED (yellow) Relay/error LED (green/red)
Data retention	EEPROM non-volatile memory
Operating mode	Light operate on NO output Dark operate on NC output
Operating temperature	–10° to 55°C (14° to 131°F)
Storage temperature	–10° to 70°C (–4° to 158°F)
Sensing distance	8–20 mm (best signal at 10 mm)
Beam type	White LED (400–700 nm)
Vibration	Amplitude: 0.5 mm Frequency: 10–55 Hz for every axis (EN60068-2-6)
Shock resistance	Half sine, 30 g <sub>n</sub> , 11 ms, 3 axes
Material of construction	PBT
Lens material	PMMA plastic
Enclosure ratings	IP67
Connections	M12 4-pin micro-connector cable
Weight	25g max.

# 5.3

## Photoelectric Sensors

### IntelliView Series Sensors

#### Detection Diagrams

##### Foreground/Background Suppression Models

Models starting with E75-PPA\_ or E76-PP1\_

##### Black/White Difference

E75-PPA010P-M12 ①

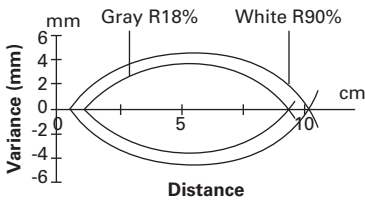

E75-PPA025P-M12 ①

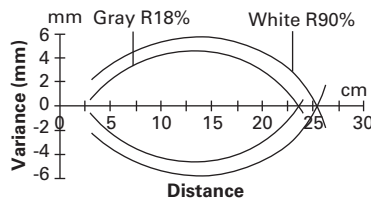

E75-PPA050P-M12 ①

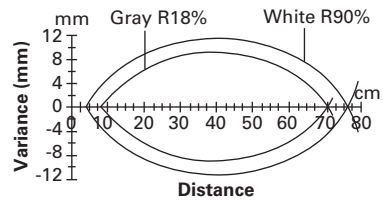

E75-PPA110P-M12

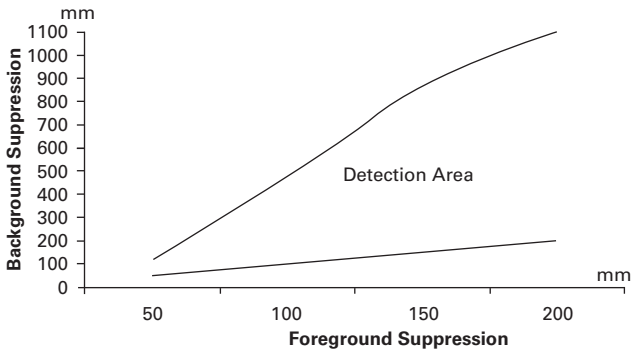

##### Distance Sensing Models (Rectangular Package Only)

Models E75-DST400A010-M12

##### Analog Output Diagram

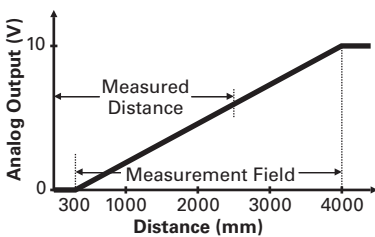

##### Digital Output Diagram

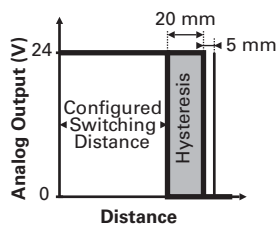

##### Black/White Difference

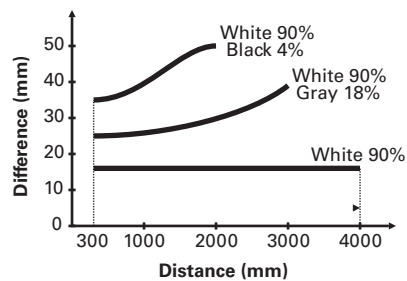

##### Note

① These diagrams depict the width of the sensing beam over distance. These diagrams also show the sensing difference between white and gray targets. Because gray is less reflective than white, gray targets will typically need to come closer to the beam centerpoint to be detected.

**Color Sensing Models**

Models E76-CLRMKN-M12, E76-CLRMKP-M12, E76-CLRMKRS-M12

**Color Detection Diagram**

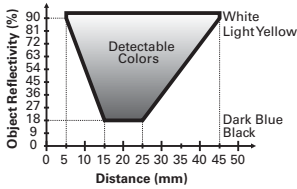

**Luminescence Sensing Models**

Models starting with E76-CN\_

**Contrast Detection Diagram**

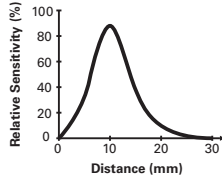

Models starting with E76-UV\_

**Luminescence Detection Diagram**

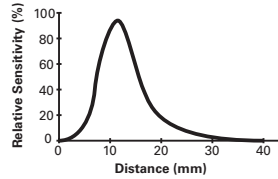

**Wiring Diagrams**

Pin numbers are for reference, rely on pin location when wiring.

**IntelliView Series Sensors**

Model	Micro-Connector Diagram (Face View Male Shown)
<b>Foreground/Background Suppression Models</b>	

Models starting with E75-PPA\_ or E76-PP1\_

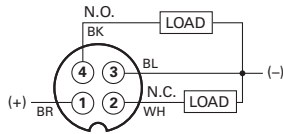

<b>Distance Sensing Models (Rectangular Package Only)</b>	
---	--

E75-DST400A010-M12

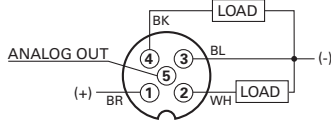

**Note**

① Available only on E76-CLRMKRS-M12 with RS485 serial connection.

Model	Micro-Connector Diagram (Face View Male Shown)
<b>Color Sensing Models</b>	

E76-CLRMKN-M12, E76-CLRMKP-M12, E76-CLRMKRS-M12

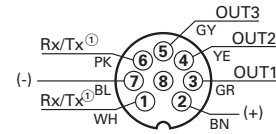

<b>Contrast and Luminescence Sensing Models</b>	
---	--

Models starting with E76-UV\_ or E76-CN\_

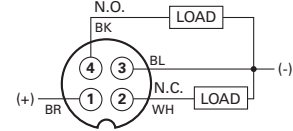

# 5.3

## Photoelectric Sensors

### IntelliView Series Sensors

#### Dimensions

Approximate dimensions in inches (mm)

#### Foreground/Background Suppression Models

Models starting with E75-PP1\_

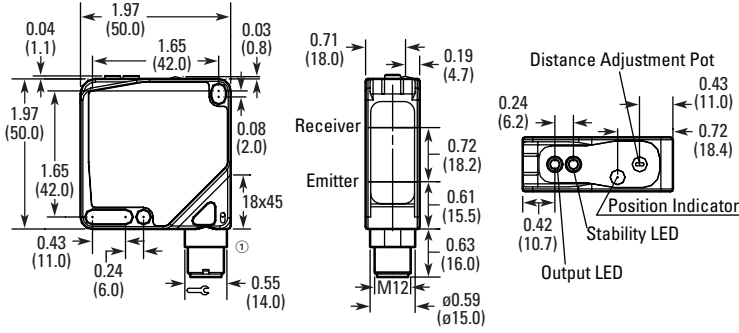

Models starting with E75-PPA\_

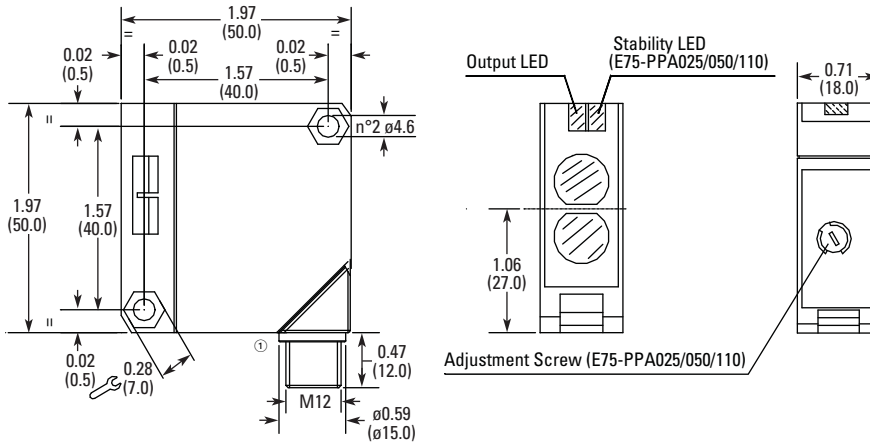

#### Note

① Connector can rotate 90 or 180 degrees to accept different sensor mounting orientations.

Approximate dimensions in inches (mm)

**Distance Sensing Models (Rectangular Package Only)**

E75-DST400A010-M12

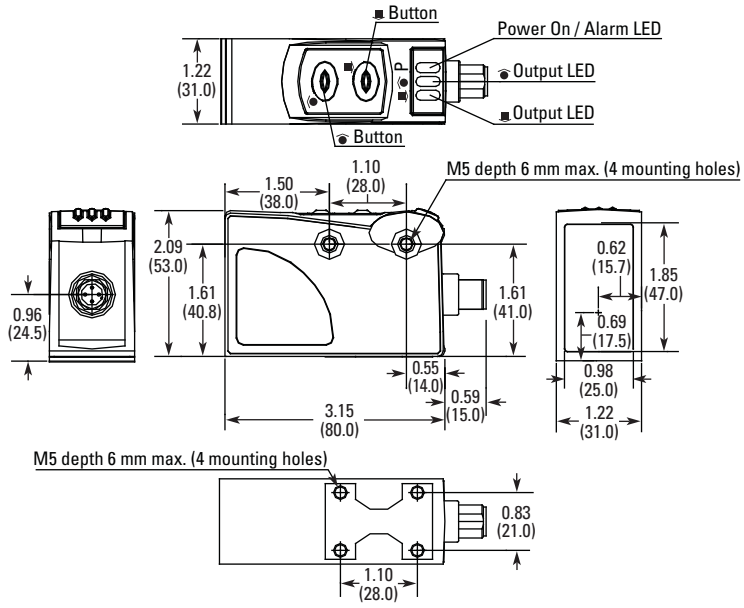

# 5.3

## Photoelectric Sensors

### IntelliView Series Sensors

Approximate dimensions in inches (mm)

#### Color Sensing Models

E76-CLRMKN-M12, E76-CLRMKP-M12, E76-CLRMKRS-M12

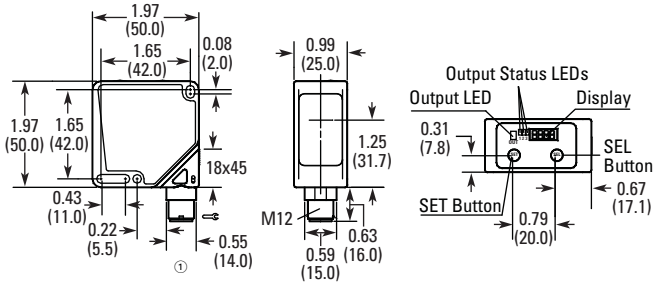

#### Contrast and Luminescence Sensing Models

Models starting with E76-UV\_ or E76-CN\_

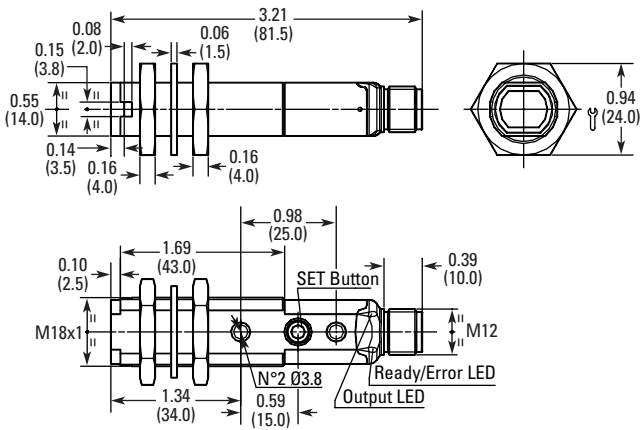

**Note**

① Connector can rotate 90 or 180 degrees to accept different sensor mounting orientations.

Approximate dimensions in inches (mm)

**Accessories—Mounting Brackets**

**E76-MTB1—Long L-Shaped Mounting Bracket**

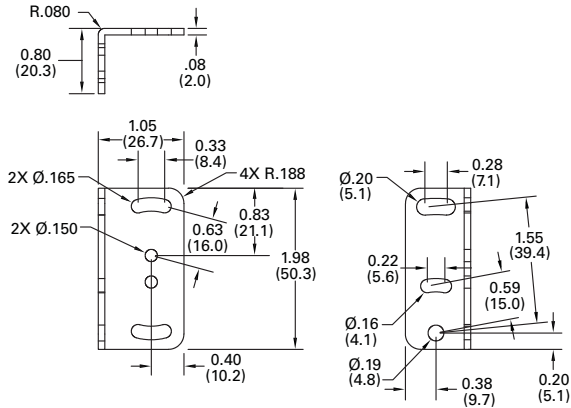

**E75-MTB1—L-Shaped Mounting Bracket**

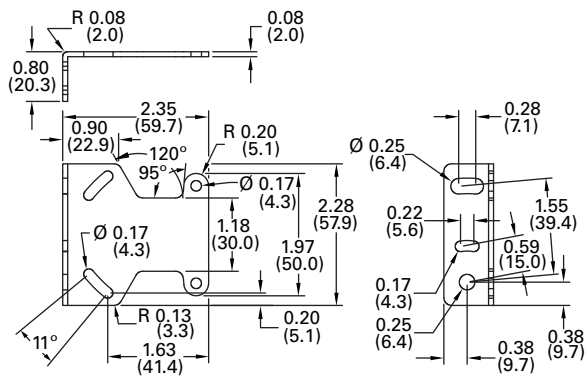

**6181AS5200—Ball Swivel**

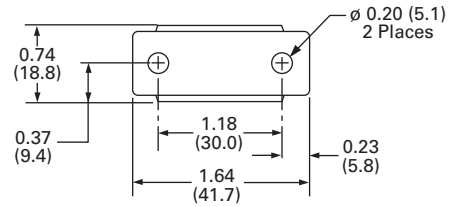

**6161AS6501—L-Shaped**

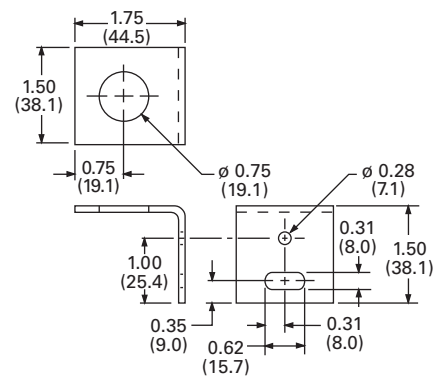





## Contents

<i>Description</i>	<i>Page</i>
SM Series Sensors	
Product Overview .....	<b>V8-T5-49</b>
Product Selection	
SM Series Sensors .....	<b>V8-T5-50</b>
Compatible Connector Cables .....	<b>V8-T5-51</b>
Accessories .....	<b>V8-T5-51</b>
Technical Data and Specifications .....	<b>V8-T5-52</b>
Excess Gain .....	<b>V8-T5-52</b>
Wiring Diagrams .....	<b>V8-T5-53</b>
Dimensions .....	<b>V8-T5-53</b>

## SM Series Sensors

### Product Description

The SM Series™ from Eaton's Electrical Sector provides high performance and ease of use in an economical, compact package.

### Lock In on Great Performance with TargetLock

A sensor can have the greatest performance in the world, but if it is slightly misaligned or the target is positioned at the wrong range, you will have reliability problems sooner or later. TargetLock™ not only simplifies sensor setup but visually confirms your sensor is positioned to operate with the highest possible reliability. In addition, TargetLock provides diagnostic information during use to inform you of impending problems before they result in equipment downtime.

### No Sensor Is Easier to Use

The SM Series includes many other features that simplify use. Visible sensing beams on all models show you exactly where the sensors are pointing. The durable housing features multiple mounting options to easily fit on your equipment in the tightest of spaces. Full protection from overvoltage, reverse polarity and short circuits reduces the chance of damage. Bright 360° LED indicators clearly show sensor status.

### Application Description

#### Typical Applications

- Packaging machines
- Conveyors and other material handling equipment
- Food processing equipment
- Assembly machines
- Pharmaceutical machines

### Features

- Highly visible LED indicators for power, output and TargetLock
- TargetLock simplifies setup and ensures the sensor operates at the highest level of reliability possible
- Perfect Prox models sense different colored targets at the same range and ignore objects in the background
- AC/DC models operate on either 18–264 Vac or 18–50 Vdc
- DC-only models feature both NPN and PNP outputs
- Visible beam on all models lets you see exactly where the sensor is pointing
- Compact size to fit in tight spaces
- Multiple mounting options including industry standard 18 mm threads
- Reverse polarity, overload and short circuit protection
- Full family includes thru-beam, polarized reflex, diffuse reflective and Perfect Prox background rejection

### Standards and Certifications

- UL Listed, E166051
- UL tested to Canadian safety standards
- CE (DC models only)
- RoHS Compliant



**⚠ DANGER**  
**THIS SENSOR IS NOT A SAFETY DEVICE AND IS NOT INTENDED TO BE USED AS A SAFETY DEVICE. This sensor is designed only to detect and read certain data in an electronic manner and perform no use apart from that, specifically no safety-related use. This sensor product does not include self-checking redundant circuitry, and the failure of this sensor product could cause either an energized or de-energized output condition, which could result in death, serious bodily injury, or property damage.**

For the most current information on this product, visit our Web site: [www.eaton.com](http://www.eaton.com)

For Customer Service in the U.S. call 1-877-ETN CARE (386-2273), in Canada call 1-800-268-3578. For Application Assistance in the U.S. and Canada call 1-800-426-9184.

**Product Overview**

**Unparalleled Optical Performance—Perfect Prox**

Exceptional background rejection sets Perfect Prox apart from all other sensors. Just point the sensor’s visible beam at the target and get reliable detection regardless of color, reflectance, contrast or surface shape, while ignoring background objects just a fraction of an inch away.

**Fast and Easy Setup**

The SM Series features an advanced 3-LED indicator display to provide valuable information at a glance. The bright display is clearly visible from 360°. In addition to LEDs for power and output status indication, the SM features a third LED that is part of the TargetLock system.

**TargetLock** is a microprocessor- controlled system that enables you to quickly and easily align the sensor and ensure it is operating most reliably.

- **Alignment:** The TargetLock LED provides a quick and easy way to set up the sensor for optimum operation. On initial setup, when you have achieved the minimum signal required for the sensor to operate, the TargetLock LED will blink in a short flash pattern. As you improve the setup and approach the best alignment and range, the LED changes from short flash to long flash to a solid ON condition. This means that even after you reach a point where the sensor will operate in the application, you are able to further fine tune the setup for highest reliability.

- **Maintenance:** Another valuable feature of the TargetLock LED is to indicate the need for maintenance prior to loss of sensor operation. Observing a change from the normal operation of the LED (for example, from solid ON to a long flash) indicates the gain has been reduced. Possible causes include bumping or vibrating out of alignment or contamination buildup on the lens. With the TargetLock LED, you are made aware of this condition before the sensor stops working, allowing you ample time to address the problem before your machine goes down.

See table (this page) for details of the function of each of the SM Series LED indicators.

**Gain Adjustment**

Thru-beam and diffuse reflective sensors include an adjustment control for optimizing the amount of gain for the application. The 3/4-turn pot provides a 10:1 adjustment of gain. A mechanical stop eliminates the possibility of sensor damage. Adjustment of the control does not require any special tools.

**Mounting**

The SM sensor features two mounting holes in the rectangular section of the body for mounting to a surface with #6 or smaller hardware. The threaded barrel and jam nut allow mounting into any 0.75 in (19 mm) hole or a selection of accessory mounting brackets available from Eaton and detailed in **Tab 8, section 8.2**.

**Mounting Sensor using #6 Hardware**

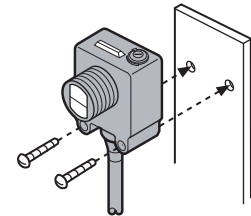

**Mounting Sensor using a Jam Nut**

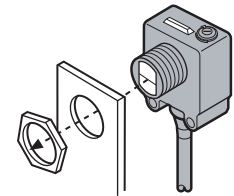

**Mounted SM Sensor in 18 mm Ball Swivel Bracket**  
See **Tab 8, section 8.2**.



**LED Indicators**

LED	State	Thru-Beam/Reflex LED Condition	Diffuse/ Perfect Prox LED Condition
<b>Power</b> (green)	ON	Power is applied to sensor	Power is applied to sensor
	OFF	No power	No power
<b>Output</b> (red)	ON	Output is ON	Output is ON
	OFF	Output is OFF	Output is OFF
	Flashing	Output is short circuited or overloaded	Output is short circuited or overloaded
<b>Target-Lock</b> (orange)	ON	Excellent alignment; sensor is operating within optimum range	Target present—excellent gain; sensor is operating within optimum range
	Long flash	Good alignment ①	Target present—good gain
	Short flash	Poor alignment ①	Target present—poor gain
	OFF	Target is present; if no target present, sensor is out of alignment or beyond range	No target, or sensor is beyond range

**Note**

① A target that doesn’t fully block the effective sensing beam or is translucent may cause a flashing indication and unreliable performance.

### Product Selection

#### SM Series Sensors

5

#### Three-Wire and Four-Wire Sensors

	Operating Voltage	Sensing Range	Optimum Range	Cutoff Range	Field of View	Thru-Beam Component	Connection Type	Light Operate Catalog Number	Dark Operate Catalog Number
<b>Thru-Beam</b> <sup>①</sup>									
 <p>Source      Detector</p>	10–30 Vdc	50 ft (15 m)	0.1 to 25 ft (30 to 7.5 m)	—	10 in (254 mm) diameter at 10 ft (3 m)	Source	2m cable	<b>E65-SMTS15-HA</b>	<b>E65-SMTS15-HA</b>
							4-pin micro DC connector	<b>E65-SMTS15-HAD</b> Ⓢ	<b>E65-SMTS15-HAD</b> Ⓢ
						Detector	2m cable	<b>E65-SMTD15-HL</b>	<b>E65-SMTD15-HD</b>
							4-pin micro DC connector	<b>E65-SMTD15-HLD</b> Ⓢ	<b>E65-SMTD15-HDD</b> Ⓢ
<b>Polarized Reflex</b> <sup>②</sup>									
 <p>Retro-reflector      Sensor</p>	18–264 Vac 50/60 Hz or 18–50 Vdc	10 ft (3 m)	0.1 to 5 ft (30 to 1.5 m)	—	1 in (25 mm) diameter at 50 in (1.3 m)	—	2m cable	<b>E65-SMPR3-GL</b>	<b>E65-SMPR3-GD</b>
							4-pin micro AC connector	<b>E65-SMPR3-GLD</b> Ⓢ	<b>E65-SMPR3-GDD</b> Ⓢ
						—	2m cable	<b>E65-SMPR3-HL</b>	<b>E65-SMPR3-HD</b>
							4-pin micro DC connector	<b>E65-SMPR3-HLD</b> Ⓢ	<b>E65-SMPR3-HDD</b> Ⓢ
<b>Diffuse Reflective</b>									
	18–264 Vac 50/60 Hz or 18–50 Vdc	8 in (200 mm) ③	0.25 to 5 in (6 to 127 mm)	—	2 in (50 mm) diameter at 5 in (127 mm)	—	2m cable	<b>E65-SMSD200-GL</b>	<b>E65-SMSD200-GD</b>
							4-pin micro AC connector	<b>E65-SMSD200-GLD</b> Ⓢ	<b>E65-SMSD200-GDD</b> Ⓢ
						—	2m cable	<b>E65-SMSD200-HL</b>	<b>E65-SMSD200-HD</b>
							4-pin micro DC connector	<b>E65-SMSD200-HLD</b> Ⓢ	<b>E65-SMSD200-HDD</b> Ⓢ
<b>Perfect Prox</b>									
	18–264 Vac 50/60 Hz or 18–50 Vdc	2 in (50 mm)	0.4 to 1.8 in (10 to 45 mm)	2.3 in (58 mm) and beyond <sup>④</sup>	0.25 in (6 mm) diameter at 2.25 in (57 mm)	—	2m cable	<b>E65-SMPP050-GL</b>	<b>E65-SMPP050-GD</b>
							4-pin micro AC connector	<b>E65-SMPP050-GLD</b> Ⓢ	<b>E65-SMPP050-GDD</b> Ⓢ
		4 in (100 mm)	0.5 to 3 in (13 to 76 mm)	5 in (127 mm) and beyond <sup>④</sup>	0.35 in (9 mm) diameter at 5 in (127 mm)	—	2m cable	<b>E65-SMPP100-GL</b>	<b>E65-SMPP100-GD</b>
							4-pin micro AC connector	<b>E65-SMPP100-GLD</b> Ⓢ	<b>E65-SMPP100-GDD</b> Ⓢ
	10–30 Vdc	2 in (50 mm)	0.4 to 1.8 in (10 to 45 mm)	2.3 in (58 mm) and beyond <sup>④</sup>	0.25 in (6 mm) diameter at 2.25 in (57 mm)	—	2m cable	<b>E65-SMPP050-HL</b>	<b>E65-SMPP050-HD</b>
							4-pin micro DC connector	<b>E65-SMPP050-HLD</b> Ⓢ	<b>E65-SMPP050-HDD</b> Ⓢ
		4 in (100 mm)	0.5 to 3 in (13 to 76 mm)	5 in (127 mm) and beyond <sup>④</sup>	0.35 in (9 mm) diameter at 5 in (127 mm)	—	2m cable	<b>E65-SMPP100-HL</b>	<b>E65-SMPP100-HD</b>
							4-pin micro DC connector	<b>E65-SMPP100-HLD</b> Ⓢ	<b>E65-SMPP100-HDD</b> Ⓢ

#### Notes

- Ⓢ See listing of compatible connector cables on **Page V8-T5-51**.
- ① For a complete system, order one source and one detector
- ② For complete system, order sensor and retroreflector (see **Tab 8, section 8.1**).
- ③ Nominal range—sensor will detect a 90% reflectance white card at this range.
- ④ Sensor will ignore a 90% reflectance white card at this range.

**Compatible Connector Cables**

**Micro-Style,  
Straight Female**



**Standard Cables—Micro** ①

Voltage Style	Number of Pins	Gauge	Length	Pin Configuration/Wire Colors (Face View Female Shown)	PVC Jacket Catalog Number	PUR Jacket Catalog Number	IRR PUR Jacket Catalog Number
<b>Micro-Style, Straight Female</b>							
AC	4-pin, 4-wire	22 AWG	6 ft (2 m)		CSAS4F4CY2202	CSAS4F4RY2202	CSAS4F4IO2202
DC	4-pin, 4-wire	22 AWG	6 ft (2 m)		CSDS4A4CY2202	CSDS4A4RY2202	CSDS4A4IO2202

**Accessories**

**SM Series Sensors**

Description	Reference
Retroreflectors and retroreflective tape	See <b>Tab 8, section 8.1</b>
Mounting brackets	See <b>Tab 8, section 8.2</b>
Replacement mounting nuts and other accessories	See <b>Tab 8, section 8.3</b>
Connector cables	See <b>Tab 10, section 10.1</b>

**Note**

① For a full selection of connector cables, see **Tab 10, section 10.1**.

### Technical Data and Specifications

#### SM Series Sensors

Description	AC/DC Model AC Operation Specification	DC Operation Specification	DC Model Specification
Input voltage	18–264 Vac, 50/60 Hz	18–50 Vdc	10–30 Vdc
Power dissipation	4 VA maximum	4 VA maximum	2W maximum
Output type	VMOS (bi-directional)	NPN (sink)	NPN and PNP (dual outputs)
Current switching	200 mA maximum	200 mA maximum	100 mA maximum
Voltage switching	264 Vac	50 Vdc	30 Vdc maximum
OFF-state leakage	500 $\mu$ A maximum	500 $\mu$ A maximum	10 $\mu$ A maximum
Surge current	2A maximum	2A maximum	1A maximum
ON-state voltage drop	3.5V maximum	3.5V maximum	2.5V maximum
Response time	16 ms	1 ms	1 ms
Protection	①	①	①
Light/dark operation	By model	By model	By model
Temperature range			
Operating	–13° to 131°F (–25° to 55°C)	–13° to 131°F (–25° to 55°C)	–13° to 131°F (–25° to 55°C)
Storage	–13° to 158°F (–25° to 70°C)	–13° to 158°F (–25° to 70°C)	–13° to 158°F (–25° to 70°C)
Material of construction	Lens: Polycarbonate; cable jacket: PVC; body: Cyclopol	Lens: Polycarbonate; cable jacket: PVC; body: Cyclopol	Lens: Polycarbonate; cable jacket: PVC; body: Cyclopol
Cable/connector	Cable models: 6 ft (2 m) four-wire cable; connector models: 4-pin, micro-connector (AC-key on AC/DC models; DC-key on DC models)	Cable models: 6 ft (2 m) four-wire cable; connector models: 4-pin, micro-connector (AC-key on AC/DC models; DC-key on DC models)	Cable models: 6 ft (2 m) four-wire cable; connector models: 4-pin, micro-connector (AC-key on AC/DC models; DC-key on DC models)
Vibration and shock	Vibration: 30g over 10 Hz to 2 kHz; shock: 50g for 10 ms 1/2 sinewave pulse	Vibration: 30g over 10 Hz to 2 kHz; shock: 50g for 10 ms 1/2 sinewave pulse	Vibration: 30g over 10 Hz to 2 kHz; shock: 50g for 10 ms 1/2 sinewave pulse
Indicator LEDs	Green LED: Power; red LED: Output; orange LED: TargetLock	Green LED: Power; red LED: Output; orange LED: TargetLock	Green LED: Power; red LED: Output; orange LED: TargetLock
Source light	Visible red, 660 nm	Visible red, 660 nm	Visible red, 660 nm
Gain adjustment	3/4-turn pot, 10:1 adjustment of gain (provided on thru-beam and diffuse reflective sensors only)	3/4-turn pot, 10:1 adjustment of gain (provided on thru-beam and diffuse reflective sensors only)	3/4-turn pot, 10:1 adjustment of gain (provided on thru-beam and diffuse reflective sensors only)
Sunlight immunity	Perfect Prox 5000 ft-candles; all others: 10,000 ft-candles	Perfect Prox 5000 ft-candles; all others: 10,000 ft-candles	Perfect Prox 5000 ft-candles; all others: 10,000 ft-candles
Enclosure ratings	NEMA 1, 3, 4, 4X, 6, 6P, 12 and 13; IP68, IP69	NEMA 1, 3, 4, 4X, 6, 6P, 12 and 13; IP68, IP69	NEMA 1, 3, 4, 4X, 6, 6P, 12 and 13; IP68, IP69

#### Excess Gain

##### Thru-Beam

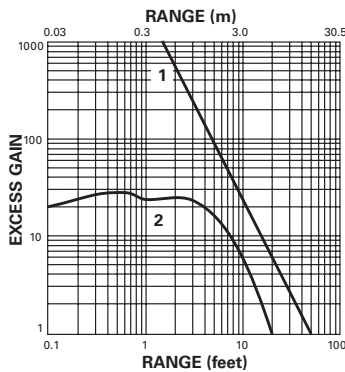

1. Thru-beam
2. Polarized reflex (based on a 3 in diameter retroreflector)

##### Perfect Prox

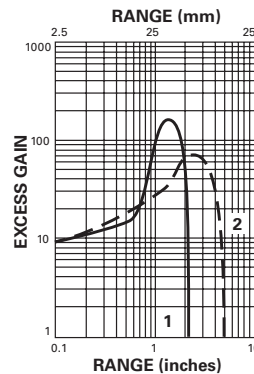

1. 50 mm Perfect Prox
2. 100 mm Perfect Prox

##### Diffuse Reflective

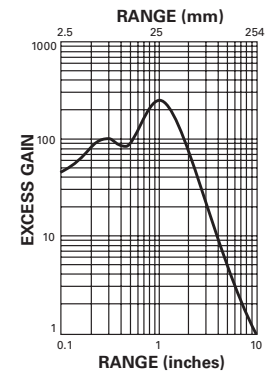

Diffuse reflective (based on a 90% reflectance white card)

#### Note

- ① Short circuit and overload protection (output indicator LED will flash). Reverse polarity protection (sensor will reset automatically once fault is removed). **IMPORTANT:** During installation, correct power connections must be made first to ensure fail-safe short circuit protection of the outputs.

### Wiring Diagrams

Pin numbers are for reference, rely on pin location when wiring.

#### SM Series Sensors

Operating Voltage	Mode	Cable Model	Micro-Connector Model (Face View Male Shown)
<b>Three-Wire Sensors</b>			
18–264 Vac, 50/60 Hz or 18–50 Vdc	All sensors		
<b>Four-Wire Sensors</b>			
10–30 Vdc	Thru-beam source		
	All others		

### Dimensions

Approximate dimensions in inches (mm)

#### SM Series Sensors

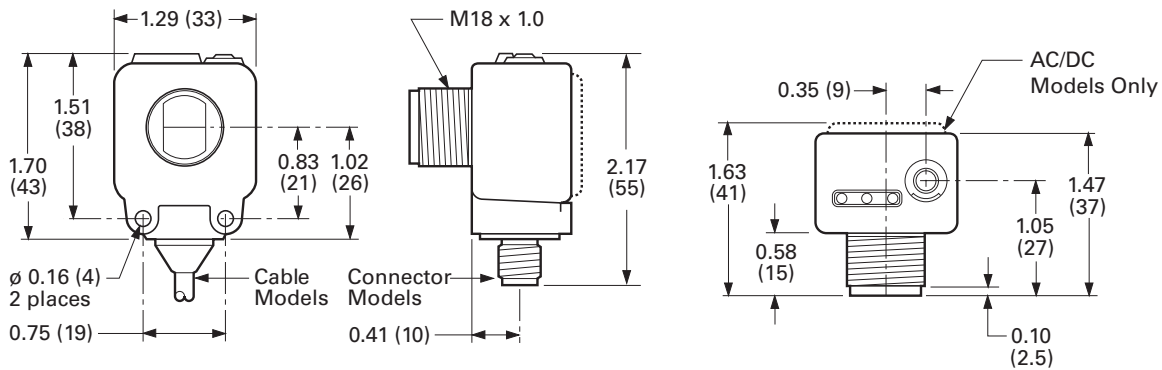

#### Comet Series Sensors



5

### Comet Series Sensors

#### Product Description

The Comet Series from Eaton's Electrical Sector is a complete line of high performance, 18 mm tubular sensors with a variety of models and modes to solve virtually any sensing problem.

The sensors are available in thru-beam, reflex, polarized reflex, diffuse reflective, focused diffuse reflective, wide angle diffuse reflective, Perfect Prox, fine spot Perfect Prox and fiber optic sensing. Perfect Prox is one of the most powerful problem-solving sensors available. These sensors can reliably detect targets of different color, reflectance, contrast or surface shape at the same range, while ignoring background objects just a fraction of an inch away.

The Comet Series includes AC/DC and DC-only models with two-, three- and four-wire circuitry. Choose from cable or micro-connector. Mini-connectors are available

on two-wire models for easy retrofit. Each sensor features a Light/Dark Operation switch and a gain control to provide for quick adjustment to peak optical performance.

The unique threaded body with flat sides allows quick mounting in a 3/4 inch hole or against any flat surface. Internal components are rigidly sealed in a solid encapsulated package for excellent performance in high-vibration and high-shock applications.

#### Features

- Industry standard 18 mm diameter threaded body has flat sides allowing it to be mounted like a tubular sensor or against any flat surface
- Right Angle viewing models mount in a depth of only 6/10th of an inch

### Contents

<i>Description</i>	<i>Page</i>
Comet Series Sensors	
Product Overview	V8-T5-55
Product Selection	
Thru-Beam Sensors	V8-T5-56
Reflex Sensors	V8-T5-57
Diffuse Reflective and Focused Diffuse Reflective Sensors	V8-T5-58
Perfect Prox Background Rejection Sensors	V8-T5-59
Fiber Optic Sensors	V8-T5-61
Glass Fiber Optic Adapter	V8-T5-61
Compatible Connector Cables	V8-T5-62
Accessories	V8-T5-62
Technical Data and Specifications	V8-T5-63
Excess Gain	V8-T5-65
Wiring Diagrams	V8-T5-66
Dimensions	V8-T5-66

- Perfect Prox technology provides exceptional background rejection and application problem-solving
- Visible sensing beams let you see where the beam is aimed for quick setup and alignment
- Solid polyurethane housing completely encapsulates internal circuits for high resistance to shock and vibration
- Adaptable modulation circuit provides immunity to crosstalk from other closely mounted sensors
- Models available with both AC and DC operation in a single unit—up to 264 Vac
- Four-wire DC sensors offer both NPN and PNP outputs
- Output status indicator visible from a wide 270° angle

#### Standards and Certifications

- UL Recognized, E117028
- CSA Certified, 50513
- CE (DC models only)
- RoHS Compliant



#### **⚠ DANGER**

**THIS SENSOR IS NOT A SAFETY DEVICE AND IS NOT INTENDED TO BE USED AS A SAFETY DEVICE. This sensor is designed only to detect and read certain data in an electronic manner and perform no use apart from that, specifically no safety-related use. This sensor product does not include self-checking redundant circuitry, and the failure of this sensor product could cause either an energized or de-energized output condition, which could result in death, serious bodily injury, or property damage.**

For the most current information on this product, visit our Web site: [www.eaton.com](http://www.eaton.com)

For Customer Service in the U.S. call 1-877-ETN CARE (386-2273), in Canada call 1-800-268-3578. For Application Assistance in the U.S. and Canada call 1-800-426-9184.



## Product Overview

### Product Comparison

Eaton's cost-effective Prism Series, OEM Prism and premium Comet Series all share the same 18 mm flat-sided housing. This results in the largest interchangeable sensor family available, allowing you to select from well over 250 different models to solve the widest variety of sensing applications.

### Comparison

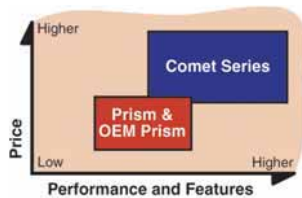

Compared to similar-looking Prism and OEM Prism, the Comet Series includes the following advantages:

- AC/DC two-wire versions available
- Light/dark output configuration
- Perfect Prox background rejection technology

### Sensing Modes

#### Thru-Beam

This sensing mode is available with ranges of 20 and 80 ft (6 and 24 m). The 20 ft (6 m) range is available in forward and Right Angle viewing, and can be intermixed in any combination for the best fit in your application. Long range models feature a visible sensing beam to help simplify installation and alignment.

#### Reflex and Polarized Reflex

In reflex sensing, the sensing beam is reflected from a retroreflector back to the sensor. The Comet Series includes standard and polarized models with two-wire, three-wire and four-wire circuits. Right Angle models are also available. Polarized models feature a polarizing filter built into the sensor to ensure that only light reflected from a corner-cube retroreflector is recognized by the sensor. This allows reliable detection of shiny targets that could reflect light and be missed by a non-polarized sensor. Most models include a visible sensing beam for easy installation and alignment.

#### Diffuse Reflective, Focused Diffuse and Wide Angle Diffuse

A wide variety of diffuse reflective models are available with ranges of 8 in (200 mm) and 24 in (610 mm). Forward and Right Angle viewing configurations offer identical optical performance in this series. Focused diffuse reflective models feature a light beam that is focused at a point 1.6 in (40 mm) in front of the sensor lens for applications where you need to avoid sensing objects in front of or behind the target. Wide angle diffuse models provide a large spot and wide detection area.

#### Perfect Prox

This is a unique type of diffuse reflective sensor that combines extremely high sensing power (called "excess gain") with a sharp optical cutoff to ignore backgrounds. This allows the sensor to reliably detect targets regardless of variations in color, reflectance, contrast or surface shape, while ignoring objects that are just slightly outside the target range. This gives the Perfect Prox an outstanding ability to solve sensing applications that would be difficult or impossible to manage with other types of sensors. It also makes Perfect Prox one of the easiest photoelectric sensors to set up and use.

Eaton's Comet Series includes more background rejection models than any other family on the market. Choose from forward or Right Angle viewing, two-, three- or four-wire circuits, cable, micro or mini-connector terminations and a variety of sensing ranges. A visible sensing beam on most models lets you quickly confirm that the sensor is aligned correctly with the target. Fine spot models provide an extremely small 0.05 in (1.3 mm) light spot for accurately detecting tiny targets such as fine strands of wire or targets that are in or behind small diameter holes.

#### Fiber Optic

The Comet Series also includes sensors that utilize fiber optic cables to sense objects where space is restricted, temperatures are high, or tight viewing angles are required. Choose from models that accept low cost plastic fiber optic cables, or use our glass fiber optic adapter that inexpensively converts our standard diffuse reflective sensors for use with durable glass fiber optic cables.

### Mounting

Comet Series sensors feature a threaded housing and include two jam nuts and washers for mounting into any 0.75 in (19 mm) hole or a selection of accessory mounting brackets available from Eaton. The flat sides of the sensor feature two mounting holes for easily attaching the sensor to any flat surface with #4 hardware.

#### Mounting Sensor using #4 Hardware

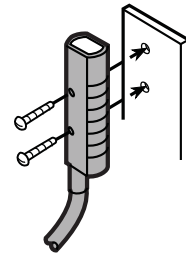

#### Mounting Sensor using a Jam Nut

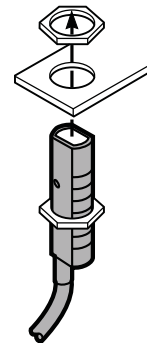

**Note:** See **Pages V8-T5-62 and V8-T5-63**, and **Tab 8, section 8.2** for a full list of mounting brackets compatible with the Comet Series.



#### Product Selection

#### Thru-Beam Sensors

5

#### Thru-Beam Forward Viewing



#### Three-Wire and Four-Wire Sensors

Operating Voltage	Sensing Range	Optimum Range	Field of View	Thru-Beam Component	Connection Type	Catalog Number
<b>Thru-Beam Forward Viewing</b> <sup>①②</sup>						
20–264 Vac 50/60 Hz or 15–30 Vdc (NPN)	20 ft (6 m)	0.1 to 10 ft (0.03 to 3 m)	30 in (760 mm) diameter at 10 ft (3 m) <sup>③</sup>	Source (Visible alignment beam)	6 ft cable	<b>11100A6513</b>
					4-pin micro AC connector	<b>11100AQD03</b> <sup>⊕</sup>
				Detector	6 ft cable	<b>12100A6513</b>
					4-pin micro AC connector	<b>12100AQD03</b> <sup>⊕</sup>
	80 ft (24 m)	0.1 to 40 ft (0.03 to 12 m)	40 in (1 m) diameter at 40 ft (12 m)	Source (Visible red beam)	6 ft cable	<b>11102A6513</b>
					4-pin micro AC connector	<b>11102AQD03</b> <sup>⊕</sup>
				Detector	6 ft cable	<b>12102A6513</b>
					4-pin micro AC connector	<b>12102AQD03</b> <sup>⊕</sup>
10–30 Vdc (NPN and PNP)	20 ft (6 m)	0.1 to 10 ft (0.03 to 3 m)	30 in (760 mm) diameter at 10 ft (3 m) <sup>③</sup>	Source (Visible alignment beam)	6 ft cable	<b>11100A6517</b>
					4-pin micro DC connector	<b>11100AQD07</b> <sup>⊕</sup>
				Detector	6 ft cable	<b>12100A6517</b>
					4-pin micro DC connector	<b>12100AQD07</b> <sup>⊕</sup>
	80 ft (24 m)	0.1 to 40 ft (0.03 to 12 m)	40 in (1 m) diameter at 40 ft (12 m)	Source (Visible red beam)	6 ft cable	<b>11102A6517</b>
					4-pin micro DC connector	<b>11102AQD07</b> <sup>⊕</sup>
				Detector	6 ft cable	<b>12102A6517</b>
					4-pin micro DC connector	<b>12102AQD07</b> <sup>⊕</sup>
<b>Thru-Beam Right Angle Viewing</b> <sup>①②</sup>						
20–264 Vac 50/60 Hz or 15–30 Vdc (NPN)	20 ft (6 m)	0.1 to 10 ft (0.03 to 3 m)	30 in (760 mm) diameter at 10 ft (3 m) <sup>③</sup>	Source (Visible alignment beam)	6 ft cable	<b>11100R6513</b>
					4-pin micro AC connector	<b>11100RQD03</b> <sup>⊕</sup>
				Detector	6 ft cable	<b>12100R6513</b>
					4-pin micro AC connector	<b>12100RQD03</b> <sup>⊕</sup>
10–30 Vdc (NPN and PNP)	20 ft (6 m)	0.1 to 10 ft (0.03 to 3 m)	30 in (760 mm) diameter at 10 ft (3 m) <sup>③</sup>	Source (Visible alignment beam)	6 ft cable	<b>11100R6517</b>
					4-pin micro DC connector	<b>11100RQD07</b> <sup>⊕</sup>
				Detector	6 ft cable	<b>12100R6517</b>
					4-pin micro DC connector	<b>12100RQD07</b> <sup>⊕</sup>

#### Notes

<sup>⊕</sup> See listing of compatible connector cables on **Page V8-T5-62**.



<sup>①</sup> For a complete system, order one source and one detector.

<sup>②</sup> 11100 sources and 12100 detectors may be interchanged in any combination. 11102 models must be used with 12102 models.







<sup>③</sup> The effective beam (minimum object size that can be detected) is 0.25 in (6.5 mm) diameter.

Reflex Sensors

Two-Wire Sensors

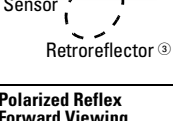
	Operating Voltage	Sensing Range ①	Optimum Range ②	Field of View	Sensing Beam	Connection Type	Catalog Number
<b>Standard Reflex Forward Viewing</b>							
 <p>Sensor Retroreflector ③</p>	90–132 Vac 50/60 Hz or 18–50 Vdc	25 ft (7.6 m)	0.1 to 15 ft (0.03 to 4.5 m)	1 in (25 mm) diameter at 50 in (1.3 m)	Visible red beam	6 ft cable	<b>14102AS6515</b>
						3-pin micro AC connector	<b>14102ASQD05</b> Ⓢ
<b>Polarized Reflex Forward Viewing ④</b>							
 <p>Sensor Retroreflector ③</p>	90–132 Vac 50/60 Hz or 18–50 Vdc	15 ft (4.5 m)	0.1 to 10 ft (0.03 to 3 m)	1 in (25 mm) diameter at 50 in (1.3 m)	Visible red beam	6 ft cable	<b>14101AS6515</b>
						3-pin micro AC connector	<b>14101ASQD05</b> Ⓢ

Three-Wire and Four-Wire Sensors

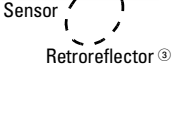



	Operating Voltage	Sensing Range ①	Optimum Range ②	Field of View	Sensing Beam	Connection Type	Catalog Number
<b>Standard Reflex Forward Viewing ⑤</b>							
 <p>Sensor Retroreflector ③</p>	20–264 Vac 50/60 Hz or 15–30 Vdc (NPN)	25 ft (7.6 m)	0.1 to 15 ft (0.03 to 4.5 m)	1 in (25 mm) diameter at 50 in (1.3 m)	Visible red beam	6 ft cable	<b>14102A6513</b>
						4-pin micro AC connector	<b>14102AQD03</b> Ⓢ
					Infrared beam	6 ft cable	<b>14100A6513</b>
						4-pin micro AC connector	<b>14100AQD03</b> Ⓢ
 <p>Sensor Retroreflector ③</p>	10–30 Vdc (NPN and PNP)	25 ft (7.6 m)	0.1 to 15 ft (0.03 to 4.5 m)	1 in (25 mm) diameter at 50 in (1.3 m)	Visible red beam	6 ft cable	<b>14102A6517</b>
						4-pin micro DC connector	<b>14102AQD07</b> Ⓢ
					Infrared beam	6 ft cable	<b>14100A6517</b>
						4-pin micro DC connector	<b>14100AQD07</b> Ⓢ
<b>Standard Reflex Right Angle Viewing ⑤</b>							
 <p>Sensor Retroreflector ③</p>	20–264 Vac 50/60 Hz or 15–30 Vdc (NPN)	15 ft (4.5 m)	0.1 to 10 ft (0.03 to 3 m)	1 in (25 mm) diameter at 50 in (1.3 m)	Visible red beam	6 ft cable	<b>14102R6513</b>
						4-pin micro AC connector	<b>14102RQD03</b> Ⓢ
 <p>Sensor Retroreflector ③</p>	10–30 Vdc (NPN and PNP)	15 ft (4.5 m)	0.1 to 10 ft (0.03 to 3 m)	1 in (25 mm) diameter at 50 in (1.3 m)	Visible red beam	6 ft cable	<b>14102R6517</b>
						4-pin micro DC connector	<b>14102RQD07</b> Ⓢ
<b>Polarized Reflex Forward Viewing ④⑤</b>							
 <p>Sensor Retroreflector ③</p>	20–264 Vac 50/60 Hz or 15–30 Vdc (NPN)	15 ft (4.5 m)	0.1 to 10 ft (0.03 to 3 m)	1 in (25 mm) diameter at 50 in (1.3 m)	Visible red beam	6 ft cable	<b>14101A6513</b>
						4-pin micro AC connector	<b>14101AQD03</b> Ⓢ
 <p>Sensor Retroreflector ③</p>	10–30 Vdc (NPN and PNP)	15 ft (4.5 m)	0.1 to 10 ft (0.03 to 3 m)	1 in (25 mm) diameter at 50 in (1.3 m)	Visible red beam	6 ft cable	<b>14101A6517</b>
						4-pin micro DC connector	<b>14101AQD07</b> Ⓢ
<b>Polarized Reflex Right Angle Viewing ②④⑤</b>							
 <p>Sensor Retroreflector ③</p>	20–264 Vac 50/60 Hz or 15–30 Vdc (NPN)	10 ft (3 m)	0.1 to 5 ft (0.03 to 1.5 m)	1 in (25 mm) diameter at 50 in (1.3 m)	Visible red beam	6 ft cable	<b>14101R6513</b>
						4-pin micro AC connector	<b>14101RQD03</b> Ⓢ
 <p>Sensor Retroreflector ③</p>	10–30 Vdc (NPN and PNP)	10 ft (3 m)	0.1 to 5 ft (0.03 to 1.5 m)	1 in (25 mm) diameter at 50 in (1.3 m)	Visible red beam	6 ft cable	<b>14101R6517</b>
						4-pin micro DC connector	<b>14101RQD07</b> Ⓢ

Notes

- Ⓢ See listing of compatible connector cables on **Page V8-T5-62**.
- ① Ranges based on a 3 in diameter retroreflector.
- ② Right Angle viewing polarized reflex models are rated NEMA 1 only.  
See Prism Series on **Page V8-T5-69** for a Right Angle viewing polarized reflex sensor rated NEMA 4X and 6.
- ③ Retroreflector is not included.
- ④ Polarized reflex sensors may not operate with retroreflective tape. Test selected tape prior to installation.
- ⑤ For complete system, order sensor and retroreflector, see **Tab 8, section 8.1**.

## Diffuse Reflective and Focused Diffuse Reflective Sensors

## Three-Wire and Four-Wire Sensors



	Operating Voltage	Sensing Range <sup>①</sup>	Optimum Range	Field of View	Sensing Beam	Connection Type	Catalog Number
<b>Diffuse Reflective Forward Viewing</b> 	<b>Diffuse Reflective Forward Viewing</b>						
	20–264 Vac 50/60 Hz or 15–30 Vdc (NPN)	8 in (200 mm)	0.1 to 5 in (3 to 127 mm)	2 in (50 mm) diameter at 5 in (127 mm)	Infrared beam	6 ft cable	<b>13106A6513</b>
		24 in (610 mm)	0.1 to 15 in (3 to 380 mm)	5 in (127 mm) diameter at 15 in (380 mm)	Infrared beam	4-pin micro AC connector	<b>13106AQD03</b> ⊕
	10–30 Vdc (NPN and PNP)	8 in (200 mm)	0.1 to 5 in (3 to 127 mm)	2 in (50 mm) diameter at 5 in (127 mm)	Infrared beam	6 ft cable	<b>13100A6513</b>
		24 in (610 mm)	0.1 to 15 in (3 to 380 mm)	5 in (127 mm) diameter at 15 in (380 mm)	Infrared beam	4-pin micro AC connector	<b>13100AQD03</b> ⊕
		8 in (200 mm)	0.1 to 5 in (3 to 127 mm)	2 in (50 mm) diameter at 5 in (127 mm)	Infrared beam	6 ft cable	<b>13106A6517</b>
24 in (610 mm)		0.1 to 15 in (3 to 380 mm)	5 in (127 mm) diameter at 15 in (380 mm)	Infrared beam	4-pin micro DC connector	<b>13106AQD07</b> ⊕	
<b>Diffuse Reflective Right Angle Viewing</b> 	<b>Diffuse Reflective Right Angle Viewing</b>						
	20–264 Vac 50/60 Hz or 15–30 Vdc (NPN)	8 in (200 mm)	0.1 to 5 in (3 to 127 mm)	2 in (50 mm) diameter at 5 in (127 mm)	Infrared beam	6 ft cable	<b>13106R6513</b>
		24 in (610 mm)	0.1 to 15 in (3 to 380 mm)	5 in (127 mm) diameter at 15 in (380 mm)	Infrared beam	4-pin micro AC connector	<b>13106RQD03</b> ⊕
	10–30 Vdc (NPN and PNP)	8 in (200 mm)	0.1 to 5 in (3 to 127 mm)	2 in (50 mm) diameter at 5 in (127 mm)	Infrared beam	6 ft cable	<b>13100R6513</b>
		24 in (610 mm)	0.1 to 15 in (3 to 380 mm)	5 in (127 mm) diameter at 15 in (380 mm)	Infrared beam	4-pin micro AC connector	<b>13100RQD03</b> ⊕
		8 in (200 mm)	0.1 to 5 in (3 to 127 mm)	2 in (50 mm) diameter at 5 in (127 mm)	Infrared beam	6 ft cable	<b>13106R6517</b>
24 in (610 mm)		0.1 to 15 in (3 to 380 mm)	5 in (127 mm) diameter at 15 in (380 mm)	Infrared beam	4-pin micro DC connector	<b>13106RQD07</b> ⊕	
<b>Wide Beam Diffuse Reflective Forward Viewing</b> 	<b>Wide Beam Diffuse Reflective Forward Viewing</b>						
	20–264 Vac 50/60 Hz or 15–30 Vdc (NPN)	6 in (150 mm)	0.1 to 4 in (3 to 101 mm)	4.3 in (109 mm) diameter at 3 in (76 mm)	Infrared beam	6 ft cable	<b>13107AS6513</b>
		6 in (150 mm)	0.1 to 4 in (3 to 101 mm)	4.3 in (109 mm) diameter at 3 in (76 mm)	Infrared beam	4-pin micro AC connector	<b>13107ASQD03</b> ⊕
	10–30 Vdc (NPN and PNP)	6 in (150 mm)	0.1 to 4 in (3 to 101 mm)	4.3 in (109 mm) diameter at 3 in (76 mm)	Infrared beam	6 ft cable	<b>13107AS6517</b>
		6 in (150 mm)	0.1 to 4 in (3 to 101 mm)	4.3 in (109 mm) diameter at 3 in (76 mm)	Infrared beam	4-pin micro DC connector	<b>13107ASQD07</b> ⊕
		6 in (150 mm)	0.1 to 4 in (3 to 101 mm)	4.3 in (109 mm) diameter at 3 in (76 mm)	Infrared beam	6 ft cable	<b>13107RS6513</b>
6 in (150 mm)		0.1 to 4 in (3 to 101 mm)	4.3 in (109 mm) diameter at 3 in (76 mm)	Infrared beam	4-pin micro AC connector	<b>13107RSQD03</b> ⊕	
<b>Wide Beam Diffuse Reflective Right Angle Viewing</b> 	<b>Wide Beam Diffuse Reflective Right Angle Viewing</b>						
	20–264 Vac 50/60 Hz or 15–30 Vdc (NPN)	6 in (150 mm)	0.1 to 4 in (3 to 101 mm)	4.3 in (109 mm) diameter at 3 in (76 mm)	Infrared beam	6 ft cable	<b>13107RS6513</b>
		6 in (150 mm)	0.1 to 4 in (3 to 101 mm)	4.3 in (109 mm) diameter at 3 in (76 mm)	Infrared beam	4-pin micro AC connector	<b>13107RSQD03</b> ⊕
	10–30 Vdc (NPN and PNP)	6 in (150 mm)	0.1 to 4 in (3 to 101 mm)	4.3 in (109 mm) diameter at 3 in (76 mm)	Infrared beam	6 ft cable	<b>13107RS6517</b>
		6 in (150 mm)	0.1 to 4 in (3 to 101 mm)	4.3 in (109 mm) diameter at 3 in (76 mm)	Infrared beam	4-pin micro DC connector	<b>13107RSQD07</b> ⊕
		6 in (150 mm)	0.1 to 4 in (3 to 101 mm)	4.3 in (109 mm) diameter at 3 in (76 mm)	Infrared beam	6 ft cable	<b>13107AS6513</b>
6 in (150 mm)		0.1 to 4 in (3 to 101 mm)	4.3 in (109 mm) diameter at 3 in (76 mm)	Infrared beam	4-pin micro AC connector	<b>13102AQD03</b> ⊕	
<b>Focused Diffuse Reflective Forward Viewing</b> 	<b>Focused Diffuse Reflective Forward Viewing</b>						
	20–264 Vac 50/60 Hz or 15–30 Vdc (NPN)	Focused at 1.6 in (40 mm)	1.5 to 1.9 in (38 to 48 mm)	0.05 in (1.3 mm) diameter at 1.6 in (40 mm)	Visible red beam	6 ft cable	<b>13102A6513</b>
		Focused at 1.6 in (40 mm)	1.5 to 1.9 in (38 to 48 mm)	0.05 in (1.3 mm) diameter at 1.6 in (40 mm)	Visible red beam	4-pin micro AC connector	<b>13102AQD03</b> ⊕
	10–30 Vdc (NPN and PNP)	Focused at 1.6 in (40 mm)	1.5 to 1.9 in (38 to 48 mm)	0.05 in (1.3 mm) diameter at 1.6 in (40 mm)	Visible red beam	6 ft cable	<b>13102A6517</b>
		Focused at 1.6 in (40 mm)	1.5 to 1.9 in (38 to 48 mm)	0.05 in (1.3 mm) diameter at 1.6 in (40 mm)	Visible red beam	4-pin micro DC connector	<b>13102AQD07</b> ⊕
		Focused at 1.6 in (40 mm)	1.5 to 1.9 in (38 to 48 mm)	0.05 in (1.3 mm) diameter at 1.6 in (40 mm)	Visible red beam	6 ft cable	<b>13102A6513</b>
Focused at 1.6 in (40 mm)		1.5 to 1.9 in (38 to 48 mm)	0.05 in (1.3 mm) diameter at 1.6 in (40 mm)	Visible red beam	4-pin micro AC connector	<b>13102AQD03</b> ⊕	

**Notes**⊕ See listing of compatible connector cables on **Page V8-T5-62**.

① Sensor will detect a 90% reflective white card at this range.

**Perfect Prox Background Rejection Sensors**

**Two-Wire Sensors**

	Operating Voltage	Nominal Range ①	Optimum Range	Cut-Off Range ②	Field of View	Sensing Beam	Connection Type	Catalog Number
 <p><b>Perfect Prox Forward Viewing</b></p>	<b>Perfect Prox Forward Viewing</b>							
	90–132 Vac 50/60 Hz or 18–50 Vdc	2 in (50 mm) sharp cutoff	0.4 to 1.8 in (10 to 45 mm)	2.25 in (57 mm) and beyond	0.25 in (6 mm) diameter at 2.25 in (64 mm)	Visible red	6 ft cable	<b>13104A6515</b>
							3-pin micro AC connector	<b>13104AQD05</b> Ⓜ
							3-pin mini-connector	<b>13104AQD25</b> Ⓜ
	4 in (100 mm) sharp cutoff	0.5 to 3 in (13 to 76 mm)	5 in (127 mm) and beyond	0.35 in (9 mm) diameter at 5 in (127 mm)	Visible red	6 ft cable	<b>13101AS6515</b> ③	
						3-pin micro AC connector	<b>13101ASQD05</b> ③ Ⓜ	
3-pin mini-connector						<b>13101ASQD25</b> ③ Ⓜ		
 <p><b>Perfect Prox Right Angle Viewing</b></p>	<b>Perfect Prox Right Angle Viewing</b>							
	90–132 Vac 50/60 Hz or 18–50 Vdc	2 in (50 mm) sharp cutoff	0.4 to 1.8 in (10 to 45 mm)	2.25 in (57 mm) and beyond	0.25 in (6 mm) diameter at 2.25 in (64 mm)	Visible red	6 ft cable	<b>13104R6515</b>
							3-pin micro AC connector	<b>13104RQD05</b> Ⓜ
							3-pin mini-connector	<b>13104RQD25</b> Ⓜ
	4 in (100 mm) sharp cutoff	0.5 to 3 in (13 to 76 mm)	5 in (127 mm) and beyond	0.35 in (9 mm) diameter at 5 in (127 mm)	Visible red	6 ft cable	<b>13101RS6515</b> ③	
						3-pin micro AC connector	<b>13101RSQD05</b> ③ Ⓜ	

**Three-Wire and Four-Wire Sensors**

	Operating Voltage	Nominal Range ①	Optimum Range	Cut-Off Range ②	Field of View	Sensing Beam	Connection Type	Catalog Number	
 <p><b>Perfect Prox Forward Viewing</b></p>	<b>Perfect Prox Forward Viewing</b>								
	20–264 Vac 50/60 Hz or 15–30 Vdc (NPN)	2 in (50 mm) sharp cutoff	0.4 to 1.8 in (10 to 45 mm)	2.25 in (57 mm) and beyond	0.25 in (6 mm) diameter at 2.25 in (64 mm)	Visible red	6 ft cable	<b>13104A6513</b>	
							4-pin micro AC connector	<b>13104AQD03</b> Ⓜ	
								6 ft cable	<b>13101A6513</b>
								4-pin micro AC connector	<b>13101AQD03</b> Ⓜ
		6 in (150 mm) standard cutoff	0.1 to 4 in (3 to 100 mm)	9 in (228 mm) and beyond	0.6 in (15 mm) diameter at 6 in (150 mm)	Infrared	6 ft cable	<b>13108A6513</b>	
							4-pin micro AC connector	<b>13108AQD03</b> Ⓜ	
	9 in (225 mm) standard cutoff	0.1 to 6 in (3 to 150 mm)	12 in (304 mm) and beyond	0.9 in (23 mm) diameter at 9 in (225 mm)	Infrared	6 ft cable	<b>13103A6513</b>		
						4-pin micro AC connector	<b>13103AQD03</b> Ⓜ		
	10–30 Vdc (NPN and PNP)	2 in (50 mm) sharp cutoff	0.4 to 1.8 in (10 to 45 mm)	2.25 in (57 mm) and beyond	0.25 in (6 mm) diameter at 2.25 in (64 mm)	Visible red	6 ft cable	<b>13104A6517</b>	
							4-pin micro DC connector	<b>13104AQD07</b> Ⓜ	
								6 ft cable	<b>13101A6517</b>
							4-pin micro DC connector	<b>13101AQD07</b> Ⓜ	
6 in (150 mm) standard cutoff		0.1 to 4 in (3 to 100 mm)	9 in (228 mm) and beyond	0.6 in (15 mm) diameter at 6 in (150 mm)	Infrared	6 ft cable	<b>13108A6517</b>		
						4-pin micro DC connector	<b>13108AQD07</b> Ⓜ		
9 in (225 mm) standard cutoff	0.1 to 6 in (3 to 150 mm)	12 in (304 mm) and beyond	0.9 in (23 mm) diameter at 9 in (225 mm)	Infrared	6 ft cable	<b>13103A6517</b>			
					4-pin micro DC connector	<b>13103AQD07</b> Ⓜ			

**Notes**

- Ⓜ Ⓜ See listing of compatible connector cables on **Page V8-T5-62**.
- ① Sensor will detect a 90% reflectance card at this range.
- ② Sensor will ignore a 90% reflectance card at this range.
- ③ Consult factory for approval status.

## Three-Wire and Four-Wire Sensors, continued

	Operating Voltage	Nominal Range ①	Optimum Range	Cut-Off Range ②	Field of View	Sensing Beam	Connection Type	Catalog Number	
<b>Perfect Prox Right Angle Viewing</b> 	<b>Perfect Prox Right Angle Viewing</b>								
	20–264 Vac 50/60 Hz or 15–30 Vdc (NPN)	2 in (50 mm) sharp cutoff	0.4 to 1.8 in (10 to 45 mm)	2.25 in (57 mm) and beyond	0.25 in (6 mm) diameter at 2.25 in (64 mm)		Visible red	6 ft cable	<b>13104R6513</b>
								4-pin micro AC connector	<b>13104RQD03</b> ☹
		4 in (100 mm) sharp cutoff	0.5 to 3 in (13 to 76 mm)	5 in (127 mm) and beyond	0.35 in (9 mm) diameter at 5 in (127 mm)		Infrared	6 ft cable	<b>13104RS5013</b>
								4-pin micro AC connector	<b>13104RS5003</b> ☹
	10–30 Vdc (NPN and PNP)	2 in (50 mm) sharp cutoff	0.4 to 1.8 in (10 to 45 mm)	2.25 in (57 mm) and beyond	0.25 in (6 mm) diameter at 2.25 in (64 mm)		Visible red	6 ft cable	<b>13104R6517</b>
								4-pin micro DC connector	<b>13104RQD07</b> ☹
		4 in (100 mm) sharp cutoff	0.5 to 3 in (13 to 76 mm)	5 in (127 mm) and beyond	0.35 in (9 mm) diameter at 5 in (127 mm)		Infrared	6 ft cable	<b>13104RS5020</b>
								4-pin micro DC connector	<b>13104RS5007</b> ☹
	Fine Spot Perfect Prox Forward Viewing	2 in (50 mm) sharp cutoff	0.9 to 1.8 in (23 to 45 mm)	2.25 in (57 mm) and beyond	0.05 in (1.3 mm) diameter at 1.7 in (43 mm)		Visible red	6 ft cable	<b>13105A6513</b>
								4-pin micro AC connector	<b>13105AQD03</b> ☹
		10–30 Vdc (NPN and PNP)	2 in (50 mm) sharp cutoff	0.9 to 1.8 in (23 to 45 mm)	2.25 in (57 mm) and beyond	0.05 in (1.3 mm) diameter at 1.7 in (43 mm)		Infrared	6 ft cable
4-pin micro DC connector									<b>13105AQD07</b> ☹

**Notes**

- ☹ See listing of compatible connector cables on [Page V8-T5-62](#).
- ① Sensor will detect a 90% reflectance card at this range.
- ② Sensor will ignore a 90% reflectance card at this range.
- ③ Consult factory for approval status.

Fiber Optic Sensors

Three-Wire and Four-Wire Sensors

Sensing Range (Optimum Range is 50% of Sensing Range) ①

Operating Voltage	Bulk Length Fibers ②		Pre-Assembled Fiber Optic Cables				Connection Type	Catalog Number
	Thru-Beam Mode	Diffuse Reflective Mode	Thru-Beam Mode		Diffuse Reflective Mode			
	0.5 mm Diameter Fibers	1 mm Diameter Fibers	0.5 mm Diameter Fibers	1 mm Diameter Fibers	0.5 mm Diameter Fibers	1 mm Diameter Fibers		
<b>18 mm Diameter Plastic Fiber Optic Forward Viewing</b>								
20–264 Vac 50/60 Hz or 15–30 Vdc (NPN)	5 in (123 mm)	1.5 in (38 mm)	2.1 in (53 mm)	5 in (127 mm)	0.6 in (15 mm)	1.5 in (38 mm)	6 ft cable	<b>15100A6513</b>
							4-pin micro AC connector	<b>15100AQD03</b> ☹
10–30 Vdc (NPN and PNP)	5 in (123 mm)	1.5 in (38 mm)	2.1 in (53 mm)	5 in (127 mm)	0.6 in (15 mm)	1.5 in (38 mm)	6 ft cable	<b>15100A6517</b>
							4-pin micro DC connector	<b>15100AQD07</b> ☹

Plastic Fiber Optic Forward Viewing



Glass Fiber Optic Adapter

Use our glass fiber optic adapter with any diffuse reflective sensor model—see below for details.

Glass Fiber Optic Adapter

This simple adapter allows glass fiber optic cables to be used with standard Comet Series diffuse reflective sensors.

Glass Fiber Optic Adapter with Hex Wrench,



Glass Fiber Optic Adapter

Sensors	Fibers	Catalog Number
<b>Glass Fiber Optic Adapter with Hex Wrench</b>		
Forward viewing, diffuse reflective sensors (ordered separately, see <a href="#">Page V8-T5-58</a> )	Glass fiber optic cables (ordered separately, see <a href="#">Tab 9, section 9.2</a> )	<b>6235A-6501</b>
	<b>Note:</b> Use only with the E51KF series fibers.	

Notes

- ☹ See listing of compatible connector cables on [Page V8-T5-62](#).
- ① Ranges are with bare fibers—no lenses. Sensing range is affected by power of sensor, length of fiber optic cable and use of lenses. Lenses will increase ranges. As bulk fiber length increases, sensing range decreases—see table below. For example, for 100 ft of fiber (the total of source and detector fiber lengths), the excess gain shown in gain graphs below would be reduced to about 1/4 its nominal value.

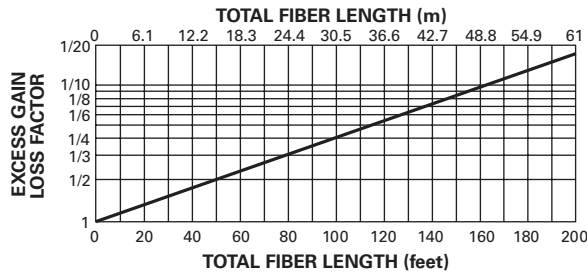



- ② Sensing range is based on 6 ft (2 m) of plastic 1 mm diameter source and detector fiber optic cable for a total length of 13.1 ft (4 m). To determine performance with longer lengths, see graph above. Compatible fiber optic cables are shown in [Tab 9, section 9.1](#).

#### Compatible Connector Cables

##### Micro-Style, Straight Female



#### Standard Cables—Micro<sup>①</sup>

Voltage Style	Number of Pins	Gauge	Length	Pin Configuration/ Wire Colors (Face View Female Shown)	PVC Jacket Catalog Number	PUR Jacket Catalog Number	IRR PUR Jacket Catalog Number
<b>Micro-Style, Straight Female</b>							
AC	3-pin, 3-wire	22 AWG	6 ft (2 m)	 1-Green 2-Red/Black 3-Red/White	CSAS3F3CY2202	CSAS3F3RY2202	—
	4-pin, 4-wire	22 AWG	6 ft (2 m)	 1-Red/Black 2-Red/White 3-Red 4-Green	CSAS4F4CY2202	CSAS4F4RY2202	CSAS4F4IO2202
DC	4-pin, 4-wire	22 AWG	6 ft (2 m)	 1-Brown 2-White 3-Blue 4-Black	CSDS4A4CY2202	CSDS4A4RY2202	CSDS4A4IO2202

5

##### Mini-Style, Straight Female





#### Standard Cables—Mini<sup>①</sup>

Current Rating at 600V	Voltage Style	Number of Pins	Gauge	Length	Pin Configuration/ Wire Colors (Face View Female Shown)	Catalog Number
<b>Mini-Style, Straight Female</b>						
13A	—	3-pin	16 AWG	6 ft (2 m)	 1-Green 2-Black 3-White	CSMS3F3CY1602

#### Accessories



##### Comet Series Sensors

Description	Catalog Number
<b>Retroreflectors</b>	
Retroreflectors and retroreflective tape	See <b>Tab 8, section 8.1</b>
<b>Mounting Brackets</b>	
A wide variety of mounting brackets for tubular sensors	See <b>Tab 8, section 8.2</b>
<b>Flush Mount Bracket</b>	
 Contoured design is ideal for flush mounting of Right Angle Comet Series reflex to mounting surface using 1/4-in hardware. No alignment adjustment. Sensor mounts on #4 studs. 304 stainless steel	6161AS5296
 Same as above except without contour. Ideal for right angle diffuse and thru-beam sensors. 304 stainless steel	6161AS5297
<b>Dimensions, see Page V8-T5-68.</b>	

##### Note

<sup>①</sup> For a full selection of connector cables, see **Tab 10, section 10.1**.

Comet Series Sensors, continued

Adjustable Protective Bracket	Description	Catalog Number
	<b>Adjustable Protective Bracket</b> Heavy-duty bracket protects the sensor from damage. Works with all Comet Series sensors except two inch Perfect Prox models. Ideal for material handling applications with Right Angle reflex sensors. Provides locking vertical and horizontal adjustments for independent adjustment in each axis. Sensor mounts on #4 studs. 10 ga. painted steel	<b>E58KS5200</b>
<b>Comet Ball Swivel Bracket</b>	<b>Comet Ball Swivel Bracket</b> Allows 360° rotation and 10° vertical tilt. Hole spacing is identical to our 50 and 55 Series sensors. Ideal for mounting Right Angle sensors. Made of Noryl.	<b>6181AS5200</b>
	<b>Accessories</b>	
	Replacement mounting brackets, nuts and other accessories	See <b>Tab 8, sections 8.2 and 8.3</b>
	<b>Connector Cables</b>	
	A variety of cables, connector blocks and accessories	See <b>Tab 10, section 10.1</b>
	<b>Dimensions, see Page V8-T5-68.</b>	

Technical Data and Specifications

Glass Fiber Optic Adapter

Description	Specification
Sensor specifications	See Comet Series specifications on <b>Page V8-T5-64</b>
Material of construction	Adapter: 360 brass; gasket: silicone
Vibration (sensor/adapter)	30g over 10 Hz to 2 kHz
Shock (sensor/adapter)	50g for 10 ms 1/2 sinewave pulse
Enclosure ratings	NEMA 1 <sup>①</sup>

Note

<sup>①</sup> The adapter will resist the entrance of moisture in the area between the lenses and the fiber ends when properly assembled. However, moisture entry is possible during direct high pressure sprays. Since the Comet Series sensors are rated NEMA 1, 2, 3, 4, 4X, 6, 12 and 13, this will not result in damage to the sensors themselves.



## Comet Series Sensors

Description	Three-Wire and Four-Wire Sensors			Two-Wire Sensors AC Models	DC Models
	AC/DC Models (AC Operation)	AC/DC Models (DC Operation)	DC-Only Models		
Input voltage	20 to 264 Vac, 50/60 Hz	15 to 30 Vdc (15 to 24 Vdc above 131°F/55°C)	10 to 30 Vdc, (10 to 24 Vdc above 131°F/55°C)	90 to 132 Vac, 50/60 Hz	18 to 50 Vdc
Power dissipation	1.5W maximum	1.5W maximum	1W maximum	2W maximum	2W maximum
Output type	VMOS (bi-directional)	NPN (sink)	NPN and PNP (dual outputs)	DMOS	DMOS
Current switching	300 mA maximum	300 mA maximum	PNP: 100 mA maximum; NPN: 250 mA maximum (NPN: 120 mA maximum above 131°F/55°C)	300 mA	300 mA
Voltage switching	375V peak maximum	375V peak maximum	30 Vdc maximum	132 Vac maximum	50 Vdc maximum
Off-state leakage	250 $\mu$ A typical; 500 $\mu$ A maximum	250 $\mu$ A typical; 500 $\mu$ A maximum	10 $\mu$ A maximum	1.7 mA maximum	1.5 mA maximum
Surge current	2A maximum	2A maximum	1A maximum	1A maximum	1A maximum
On-state voltage drop	—	1.8V at 10 mA; 3.5V at 300 mA	NPN: 400 mV at 10 mA, 1.5V at 250 mA; PNP: 2.4V at 100 mA	10 Vac	8 Vdc
Response time	10 ms	10 ms	1 ms; 3.5 ms (thru-beam)	32 ms	32 ms
Time delay	Models with fixed time delay available—contact factory	Models with fixed time delay available—contact factory	Models with fixed time delay available—contact factory	Models with fixed time delay available—contact factory	Models with fixed time delay available—contact factory
Short circuit protection	①	①	②	Auto reset	Auto reset
Temperature range					
Thru-beam source	−4° to 158°F (−20° to 70°C)	−4° to 158°F (−20° to 70°C)	−4° to 158°F (−20° to 70°C)	−13° to 131°F (−25° to 55°C)	−13° to 131°F (−25° to 55°C)
All others	−40° to 158°F (−40° to 70°C)	−40° to 158°F (−40° to 70°C)	−40° to 158°F (−40° to 70°C)	—	—
Light/dark operation	Switch selectable	Switch selectable	Switch selectable	Switch selectable	Switch selectable
Description	All Models				
Enclosure material	Lens: polycarbonate; cable jacket: PVC; body: structural polyurethane foam (do not expose to concentrated acids, alcohols or ketones)				
Cable/connector	Cable versions: 6 ft cable (22 AWG) Connector versions: Male mini- and micro-connectors (refer to wiring diagrams for number of pins per model) on nominal 8 in pigtailed				
Vibration and shock	Vibration: 30g over 10 Hz to 2 kHz; shock: 100g for 3 ms 1/2 sine wave pulse				
Indicator LED	Lights steady when output is ON; flashes when short circuit protection is in latch condition (except two-wire models)				
Sunlight immunity	Perfect Prox: 5000 ft-candles; all others: 10,000 ft-candles				
Enclosure ratings	NEMA 1, 2, 3, 4, 4X, 6, 12 and 13 ③④; IP69				

**Notes**

- ① Sensor will turn off immediately when short or overload is detected (indicator LED flashes). Turn power OFF and back ON to reset.  
**IMPORTANT:** During installation, correct power connections must be made first to ensure fail-safe short circuit protection of outputs.
- ② Sensor will turn off immediately when short or overload is detected (indicator LED flashes). Sensor will reset when short is removed.
- ③ These products conform to NEMA tests as indicated, however, some severe washdown applications can exceed these NEMA test specifications.
- ④ NEMA 6P models available—contact factory.

**Excess Gain**

**Thru-Beam Sensors**

**Thru-Beam**

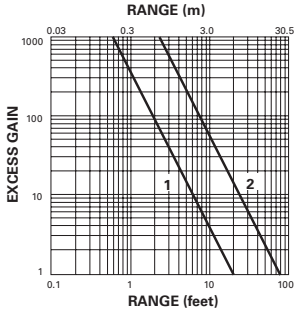

1. 12100A and 12100R detectors using 11100A or 11100R sources
2. 12102A detectors using 11102A sources

**Reflex Sensors, Diffuse Reflective Sensors and Focused Diffuse Reflective Sensors**

**Reflex (3 In Diameter Retroreflector)**

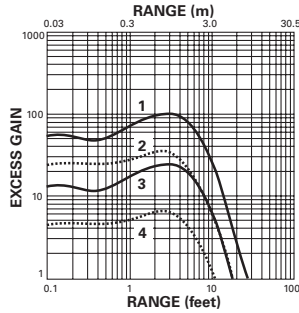

1. 14100A/14102A
2. 14102R
3. 14101A
4. 14101R

**Diffuse Reflective (90% Reflective White Card)**

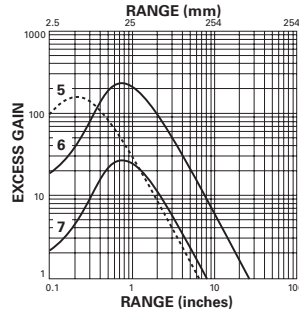

5. 13107
6. 13100
7. 13106

**Focused Diffuse Reflective**

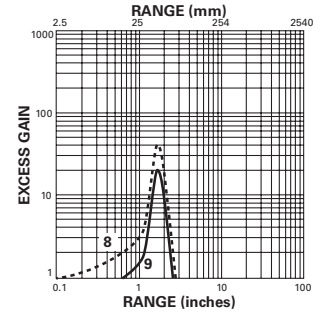

8. 13102A Typical
9. 13102A Minimum

**Perfect Prox Sensors**

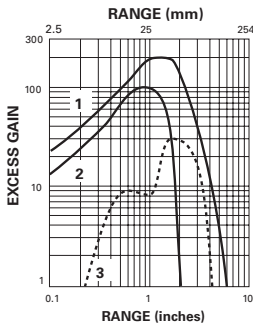

1. 13108A/13108R
2. 13104A
3. 13104RS

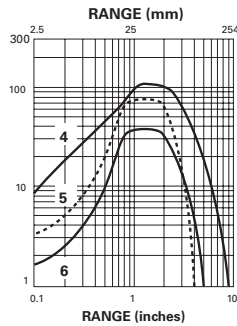

4. 13103A/13103R
5. 13101A Typical
6. 13101A Minimum

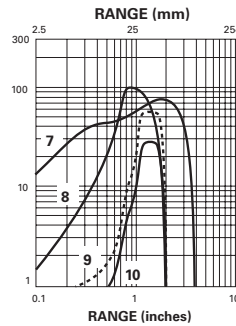

7. 13101AS
8. 13104R
9. 13105A Typical
10. 13105A Minimum

**Fiber Optic Sensors (Performance using 13.1 ft [4m] of fiber)**

**Thru-Beam Mode**

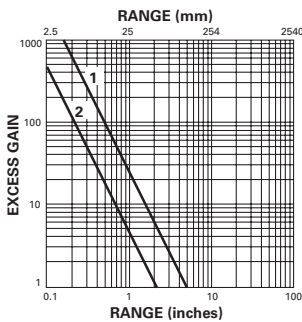

1. 15100 with 1 mm diameter fibers
2. 15100 with 0.5 mm diameter fibers

**Diffuse Reflective Mode**

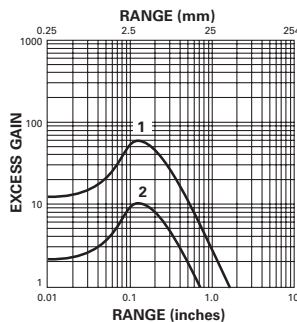

1. 15100 with 1 mm diameter fibers
2. 15100 with 0.5 mm diameter fibers

**Glass Fiber Optic Adapters**

**When Using Single Fibers for Thru-Beam Sensing**

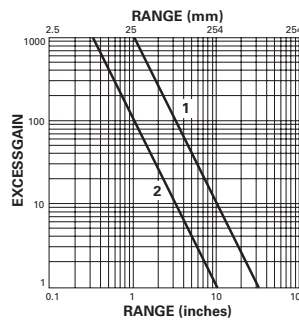

- Gain using E51KF823 fibers
1. 13100A Comet
  2. 13106A Comet

**When Using Duplex Fibers for Diffuse Reflective Sensing**

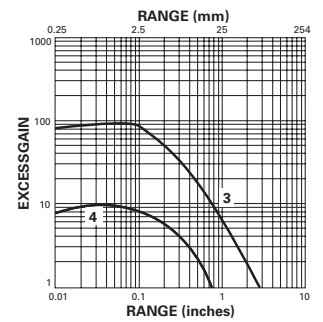

- Gain using E51KF723 fibers, based on 90% reflective white card
3. 13100A Comet
  4. 13106A Comet

# 5.5

## Photoelectric Sensors

### Comet Series Sensors

#### Wiring Diagrams

Pin numbers are for reference, rely on pin location when wiring.

#### AC/DC Models (AC Connection)

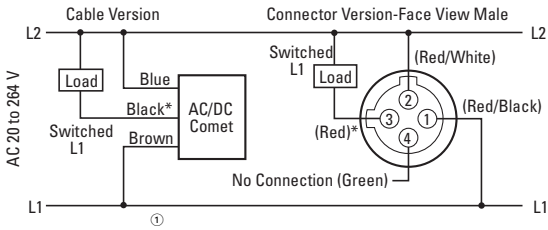

#### DC Models (Two-Wire)

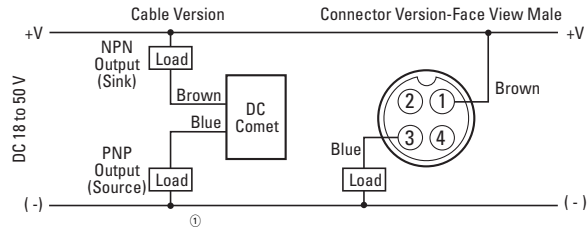

#### AC Models (AC Connection)

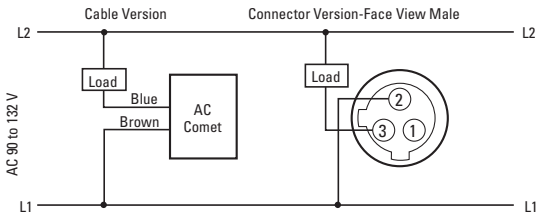

#### DC Models (Four-Wire)

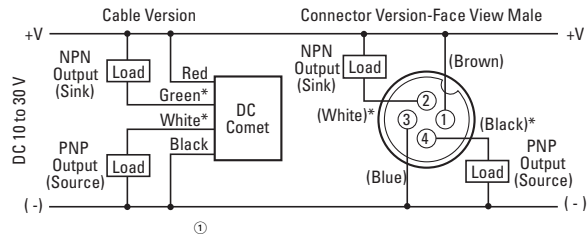

#### AC/DC Models (DC Connection)

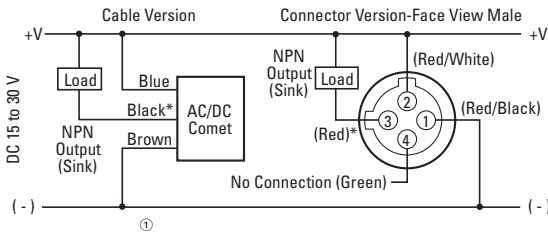

#### Notes

**CAUTION:** AC/DC connector version sensors use an AC-type connector. Use of DC power with AC-type connectors may not conform with established standards.

For connector versions, the pin numbering and color codes shown are typical of several manufacturers. However, variations are possible. In case of discrepancies, rely on function indicated and pin location rather than pin number or color code.

\* No connection when using thru-beam sources.

#### Dimensions

Approximate dimensions in inches (mm), unless otherwise noted

#### Sensor with Adapter Installed

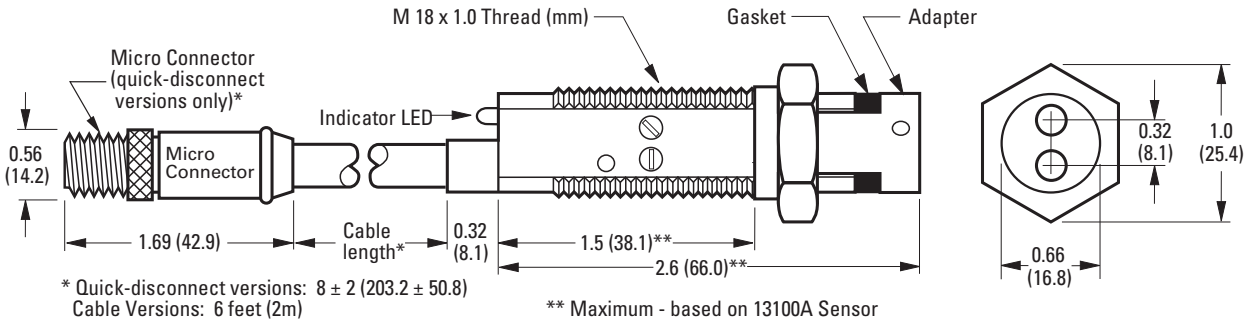

Approximate dimensions in inches (mm), unless otherwise noted

Comet Series Sensor Dimensions and Specifications

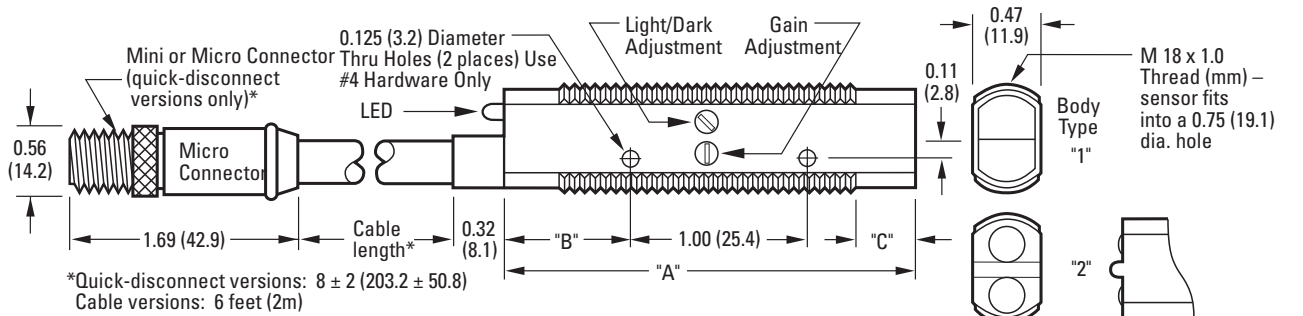

Catalog Number	Dimensions				Adjustments		Body Type
	A	B	C	D	Light/ Dark	Gain	
11100A	2.20 (56)	0.65 (17)	0.25 (6)	N/A	No	No	2
11100R	2.55 (65)	0.65 (17)	0.60 (15)	0.20 (5)	No	No	4
11102A	2.75 (70)	0.65 (17)	1.10 (28)	N/A	No	No	1
12100A	2.20 (56)	0.65 (17)	0.25 (6)	N/A	Yes	Yes	2
12100R	2.55 (65)	0.65 (17)	0.60 (15)	0.20 (5)	Yes	Yes	4
12102A	2.60 (66)	0.60 (15)	0.29 (7)	N/A	Yes	Yes	1
13100A, 13106A	2.20 (56)	0.65 (17)	0.25 (6)	N/A	Yes	Yes	2
13100R, 13106R	2.55 (65)	0.65 (17)	0.60 (15)	0.20 (5)	Yes	Yes	4
13101A, 13104A	2.60 (66)	0.60 (15)	0.25 (6)	N/A	Yes	No	1
13102A, 13103A, 13105A, 13108A	2.60 (66)	0.60 (15)	0.25 (6)	N/A	Yes	Yes	1
13104R	3.02 (77)	0.60 (15)	1.10 (28)	0.20 (5)	Yes	No	6
14100A, 14102A	2.60 (66)	0.60 (15)	0.29 (7)	N/A	Yes	Yes	1
14101R, 14102R	3.00 (76)	0.60 (15)	0.70 (18)	0.20 (5)	Yes	Yes	5
14101A	2.64 (67)	0.60 (15)	0.29 (7)	N/A	Yes	Yes	1
15100A, 15101A	2.87 (73)	0.60 (15)	0.60 (15)	N/A	Yes	Yes	3

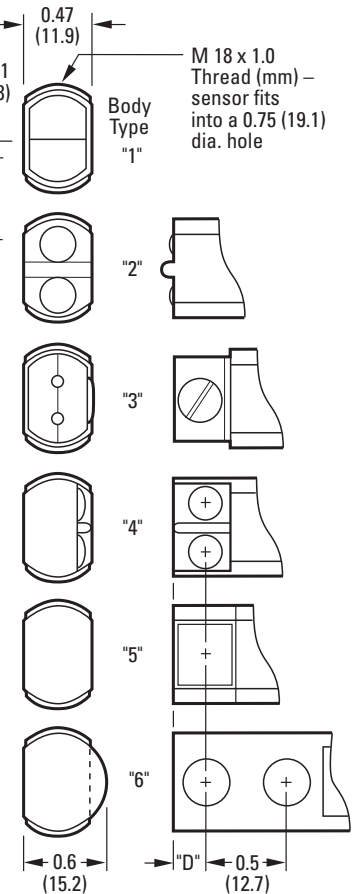

# 5.5

## Photoelectric Sensors

### Comet Series Sensors

Approximate dimensions in inches (mm), unless otherwise noted

#### Accessories

##### Flush Mount Bracket—6161AS5296

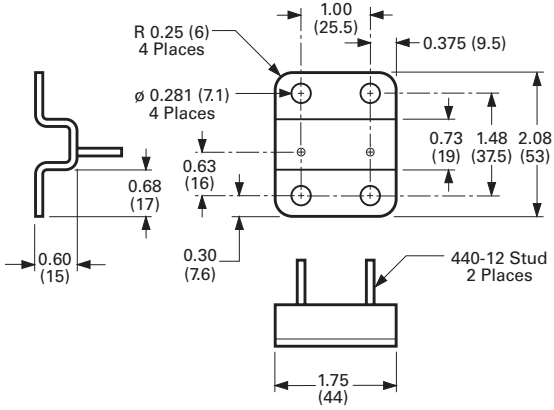

##### Adjustable Protective Bracket

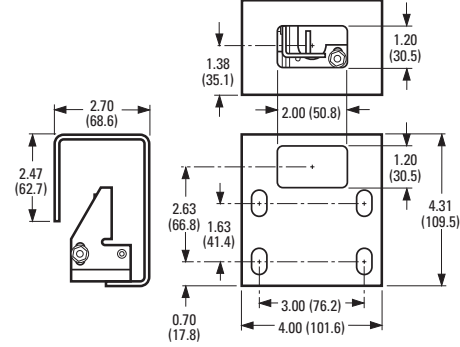

##### Flush Mount Bracket—6161AS5297

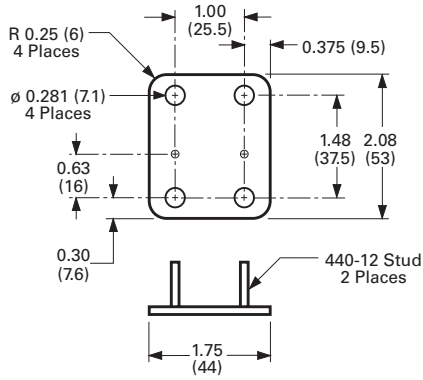

##### Comet Ball Swivel Bracket

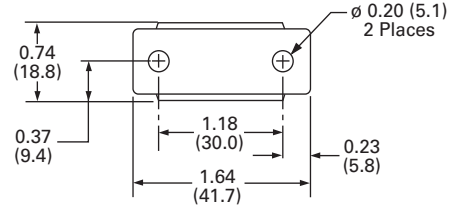

### Prism Series Sensors



### Contents

<b>Description</b>	<b>Page</b>
Prism Series Sensors	
Product Overview . . . . .	<b>V8-T5-70</b>
Product Selection	
Thru-Beam Sensors . . . . .	<b>V8-T5-70</b>
Reflex and Diffuse Reflective Sensors . . . . .	<b>V8-T5-71</b>
Glass Fiber Optic Adapter . . . . .	<b>V8-T5-71</b>
Compatible Connector Cables . . . . .	<b>V8-T5-72</b>
Accessories . . . . .	<b>V8-T5-72</b>
Technical Data and Specifications . . . . .	<b>V8-T5-73</b>
Excess Gain . . . . .	<b>V8-T5-74</b>
Wiring Diagrams . . . . .	<b>V8-T5-75</b>
Dimensions . . . . .	<b>V8-T5-76</b>

## Prism Series Sensors

### Product Description

The Prism Series from Eaton's Electrical Sector is a cost-effective line of miniature photoelectric sensors with twice the optical gain of other sensors in this product class. Forward and Right Angle viewing models feature identical gain and optical characteristics for the best fit on your machine. A gain control allows quick adjustment for peak optical performance in a variety of applications.

Four sensing modes are available, including polarized reflex to eliminate reliability problems when sensing shiny objects. Visible red sensing beams throughout the Prism Series allow you to see exactly where the sensors are aimed for easier setup. Models are available preconfigured in either light or dark operate modes.

The unique threaded body with flat sides allows quick mounting in a 3/4 in hole or against any flat surface. Internal components are rigidly sealed in a solid encapsulated package for excellent performance in high-vibration and high-shock applications.

See **Page V8-T5-73** for details on the Prism Series' flexible isolated output.

### Features

- Small size for use in a wide variety of applications and locations
- High sensing power for longer ranges and resistance to dust and dirt
- Adjustable gain control to ensure peak optical performance
- High noise immunity which greatly reduces problems associated with electrical noise
- AC/DC models which allow you to order and stock one model for both voltages
- DC only models which offer lower cost options in all sensing modes
- Isolated outputs for wiring flexibility
- Short circuit protection
- Quick 3 ms response time on all models
- Highly visible output status LED
- Built-in cable models allow for lowest cost wiring
- Micro-connector models provide for quick installation or replacement
- Custom cable length options

### Standards and Certifications

- UL Recognized, E117028
- UL tested to Canadian safety standards
- CE (DC reflex forward viewing only)
- RoHS Compliant



### **!** DANGER

**THIS SENSOR IS NOT A SAFETY DEVICE AND IS NOT INTENDED TO BE USED AS A SAFETY DEVICE. This sensor is designed only to detect and read certain data in an electronic manner and perform no use apart from that, specifically no safety-related use. This sensor product does not include self-checking redundant circuitry, and the failure of this sensor product could cause either an energized or de-energized output condition, which could result in death, serious bodily injury, or property damage.**

For Customer Service in the U.S. call 1-877-ETN CARE (386-2273), in Canada call 1-800-268-3578.  
For Application Assistance in the U.S. and Canada call 1-800-426-9184.

For the most current information on this product, visit our Web site: [www.eaton.com](http://www.eaton.com)

### Product Overview

#### Product Comparison

Eaton's cost-effective Prism Series, OEM Prism and premium Comet Series all share the same 18 mm flat-sided housing. This results in the largest interchangeable sensor family available, allowing you to select from well over 250 different models to solve the widest variety of sensing applications.

#### Comparison

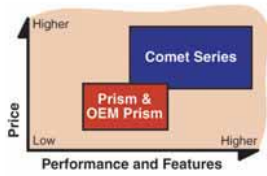

Compared to the similar-looking Comet, the Prism Series is optimized for value, with a basic feature set best suited for OEMs:

- DC and AC/DC versions
- Isolated AC/DC solid-state outputs

#### Prism Series

##### Easy and Flexible Wiring

Prism's isolated output simplifies wiring because it acts like a mechanical relay contact but with solid-state speed and reliability. Use the most convenient available voltage for the sensor while switching to a different voltage with the isolated contact. NPN or PNP is easily determined by the way you wire the output.

##### Wiring the Prism Series for Logic

With Prism, you can perform simple "and/or" logic without the need for the added cost of an external controller. Low leakage (10  $\mu$ A) and resistance ratings (25 ohms) allow Prism sensor outputs to be wired in series or parallel. Two common logic examples are shown at right:

##### "OR" Function

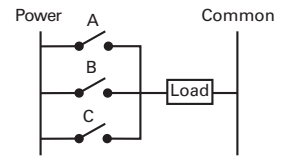

A	B	C	OUTPUT
off	off	off	off
ON	off	off	ON
off	ON	off	ON
off	off	ON	ON

##### "AND" Function

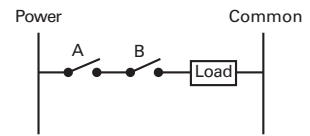





A	B	OUTPUT
off	off	off
ON	off	off
off	ON	off
ON	ON	ON

### Product Selection

#### Thru-Beam Sensors

##### Three-Wire and Four-Wire Sensors

	Operating Voltage	Sensing Range	Optimum Range	Field of View	Thru-Beam Component	Connection Type	Light Operate Catalog Number	Dark Operate Catalog Number
<b>Thru-Beam Forward Viewing</b>								
<b>Thru-Beam Forward Viewing</b> <sup>①</sup> 	20–132 Vac 50/60 Hz or 15–30 Vdc	20 ft (6 m)	0.1 to 10 ft (0.03 to 3 m)	20 in (0.5 m) diameter at 10 ft (3 m)	Source	6 ft cable	<b>11155AA14</b>	<b>11155AA14</b>
						4-pin micro AC connector	<b>11155AA04</b> <sup>⊕</sup>	<b>11155AA04</b> <sup>⊕</sup>
					Detector	6 ft cable	<b>12155AL10</b>	<b>12155AD10</b>
						4-pin micro AC connector	<b>12155AL04</b> <sup>⊕</sup>	<b>12155AD04</b> <sup>⊕</sup>
<b>Thru-Beam Forward Viewing</b> <sup>①</sup> 	10–30 Vdc	20 ft (6 m)	0.1 to 10 ft (0.03 to 3 m)	20 in (0.5 m) diameter at 10 ft (3 m)	Source	6 ft cable	<b>11155AA17</b>	<b>11155AA17</b>
						4-pin micro DC connector	<b>11155AA07</b> <sup>⊕</sup>	<b>11155AA07</b> <sup>⊕</sup>
					Detector	6 ft cable	<b>12155AL10</b>	<b>12155AD10</b>
						4-pin micro DC connector	<b>12155AL07</b> <sup>⊕</sup>	<b>12155AD07</b> <sup>⊕</sup>
<b>Thru-Beam Right Angle Viewing</b>								
<b>Thru-Beam Right Angle Viewing</b> <sup>①</sup> 	20–132 Vac 50/60 Hz or 15–30 Vdc	20 ft (6 m)	0.1 to 10 ft (0.03 to 3 m)	20 in (0.5 m) diameter at 10 ft (3 m)	Source	6 ft cable	<b>11155RA14</b>	<b>11155RA14</b>
						4-pin micro AC connector	<b>11155RA04</b> <sup>⊕</sup>	<b>11155RA04</b> <sup>⊕</sup>
					Detector	6 ft cable	<b>12155RL10</b>	<b>12155RD10</b>
						4-pin micro AC connector	<b>12155RL04</b> <sup>⊕</sup>	<b>12155RD04</b> <sup>⊕</sup>
<b>Thru-Beam Right Angle Viewing</b> <sup>①</sup> 	10–30 Vdc	20 ft (6 m)	0.1 to 10 ft (0.03 to 3 m)	20 in (0.5 m) diameter at 10 ft (3 m)	Source	6 ft cable	<b>11155RA17</b>	<b>11155RA17</b>
						4-pin micro DC connector	<b>11155RA07</b> <sup>⊕</sup>	<b>11155RA07</b> <sup>⊕</sup>
					Detector	6 ft cable	<b>12155RL10</b>	<b>12155RD10</b>
						4-pin micro DC connector	<b>12155RL07</b> <sup>⊕</sup>	<b>12155RD07</b> <sup>⊕</sup>

Wiring Diagrams, see Page V8-T5-75.





#### Notes

<sup>⊕</sup> See listing of compatible connector cables on Page V8-T5-72.

<sup>①</sup> Synchronous design requires source and detector to be wired to one another.

**Reflex and Diffuse Reflective Sensors**

**Three-Wire and Four-Wire Sensors**

	Operating Voltage	Type	Sensing Range	Optimum Range	Field of View	Connection Type	Light Operate Catalog Number	Dark Operate Catalog Number	
<b>Reflex—Forward Viewing</b> 	<b>Reflex—Forward Viewing</b>								
	20–132 Vac 50/60 Hz or 15–30 Vdc	Standard reflex	15 ft (4.5 m) ③	0.1 to 12 ft (0.03 to 3.6 m)	3 in (76 mm) diameter at 12 ft (3.6 m)	6 ft cable	<b>14150AL14</b>	<b>14150AD14</b>	
		Polarized reflex	10 ft (3 m) ③	0.1 to 8 ft (0.03 to 2.4 m)		4-pin micro AC connector	<b>14150AL04</b> ☹	<b>14150AD04</b> ☹	
	10–30 Vdc	Standard reflex	15 ft (4.5 m) ③	0.1 to 12 ft (0.03 to 3.6 m)	3 in (76 mm) diameter at 12 ft (3.6 m)	6 ft cable	<b>14150AL17</b>	<b>14150AD17</b>	
		Polarized reflex	10 ft (3 m) ③	0.1 to 8 ft (0.03 to 2.4 m)		4-pin micro DC connector	<b>14150AL07</b> ☹	<b>14150AD07</b> ☹	
	<b>Reflex—Right Angle Viewing</b> 	<b>Reflex—Right Angle Viewing</b>							
20–132 Vac 50/60 Hz or 15–30 Vdc		Standard reflex	15 ft (4.5 m) ③	0.1 to 12 ft (0.03 to 3.6 m)	3 in (76 mm) diameter at 12 ft (3.6 m)	6 ft cable	<b>14150RL14</b>	<b>14150RD14</b>	
		Polarized reflex	10 ft (3 m) ③	0.1 to 8 ft (0.03 to 2.4 m)		4-pin micro AC connector	<b>14150RL04</b> ☹	<b>14150RD04</b> ☹	
10–30 Vdc		Standard reflex	15 ft (4.5 m) ③	0.1 to 12 ft (0.03 to 3.6 m)	3 in (76 mm) diameter at 12 ft (3.6 m)	6 ft cable	<b>14150RL17</b>	<b>14150RD17</b>	
		Polarized reflex	10 ft (3 m) ③	0.1 to 8 ft (0.03 to 2.4 m)		4-pin micro DC connector	<b>14150RL07</b> ☹	<b>14150RD07</b> ☹	
<b>Diffuse Reflective Forward Viewing</b> 		<b>Diffuse Reflective Forward Viewing</b>							
	20–132 Vac 50/60 Hz or 15–30 Vdc	—	8 in (200 mm) ④	0.15 to 5 in (4 to 127 mm)	0.6 in (15 mm) diameter at 5 in (127 mm)	6 ft cable	<b>13150AL14</b>	<b>13150AD14</b>	
		—	8 in (200 mm) ④	0.15 to 5 in (4 to 127 mm)	0.6 in (15 mm) diameter at 5 in (127 mm)	4-pin micro AC connector	<b>13150AL04</b> ☹	<b>13150AD04</b> ☹	
	10–30 Vdc	—	8 in (200 mm) ④	0.15 to 5 in (4 to 127 mm)	0.6 in (15 mm) diameter at 5 in (127 mm)	6 ft cable	<b>13150AL17</b>	<b>13150AD17</b>	
—		8 in (200 mm) ④	0.15 to 5 in (4 to 127 mm)	0.6 in (15 mm) diameter at 5 in (127 mm)	4-pin micro DC connector	<b>13150AL07</b> ☹	<b>13150AD07</b> ☹		
<b>Diffuse Reflective Right Angle Viewing</b> 	<b>Diffuse Reflective Right Angle Viewing</b>								
	20–132 Vac 50/60 Hz or 15–30 Vdc	—	8 in (200 mm) ④	0.15 to 5 in (4 to 127 mm)	0.6 in (15 mm) diameter at 5 in (127 mm)	6 ft cable	<b>13150RL14</b>	<b>13150RD14</b>	
		—	8 in (200 mm) ④	0.15 to 5 in (4 to 127 mm)	0.6 in (15 mm) diameter at 5 in (127 mm)	4-pin micro AC connector	<b>13150RL04</b> ☹	<b>13150RD04</b> ☹	
	10–30 Vdc	—	8 in (200 mm) ④	0.15 to 5 in (4 to 127 mm)	0.6 in (15 mm) diameter at 5 in (127 mm)	6 ft cable	<b>13150RL17</b>	<b>13150RD17</b>	
—		8 in (200 mm) ④	0.15 to 5 in (4 to 127 mm)	0.6 in (15 mm) diameter at 5 in (127 mm)	4-pin micro DC connector	<b>13150RL07</b> ☹	<b>13150RD07</b> ☹		

**Glass Fiber Optic Adapter**

This simple adapter allows glass fiber optic cables to be used with standard Comet Series diffuse reflective sensors.

**Glass Fiber Optic Adapter with Hex Wrench**



**Glass Fiber Optic Adapter**

Sensors	Fibers	Catalog Number
<b>Glass Fiber Optic Adapter with Hex Wrench</b>		
Forward viewing, diffuse reflective sensors (ordered separately, see table above)	Glass fiber optic cables (ordered separately, see <b>Tab 9, section 9.2</b> )	<b>6235A-6501</b>

**Notes**

- ☹ See listing of compatible connector cables on **Page V8-T5-72**.
- ① For complete system, order sensor and retroreflector (see **Tab 8, section 8.1**).
- ② Retroreflector not included.
- ③ Ranges based on a 3 in diameter retroreflector.
- ④ Sensor will detect a 90% reflectance white card at this range.



# 5.6

## Photoelectric Sensors



### Prism Series Sensors

#### Compatible Connector Cables

Micro-Style,  
Straight Female



#### Standard Cables—Micro <sup>①</sup>

Voltage Style	Number of Pins	Gauge	Length	Pin Configuration/ Wire Colors (Face View Female Shown)	PVC Jacket Catalog Number	PUR Jacket Catalog Number	IRR PUR Jacket Catalog Number
<b>Micro-Style, Straight Female</b>							
AC	4-pin, 4-wire	22 AWG	6 ft (2 m)	 1-Red/Black 2-Red/White 3-Red 4-Green	CSAS4F4CY2202	CSAS4F4RY2202	CSAS4F4IO2202
DC	4-pin, 4-wire	22 AWG	6 ft (2 m)	 1-Brown 2-White 3-Blue 4-Black	CSDS4A4CY2202	CSDS4A4RY2202	CSDS4A4IO2202

5

#### Accessories

#### Prism Series Sensors

Description	Catalog Number
<b>Retroreflectors</b>	
Retroreflectors and retroreflective tape	See <b>Tab 8, section 8.1</b>
<b>Mounting Brackets</b>	
A wide variety of mounting brackets for tubular sensors	See <b>Tab 8, section 8.2</b>
<b>Flush Mount Bracket</b>	
Contoured design is ideal for flush mounting of Right Angle Prism Series reflex to mounting surface using 1/4 in hardware. No alignment adjustment. Sensor mounts on #4 studs. 304 stainless steel	<b>6161AS5296</b>
<b>Flush Mount Bracket</b>	
Same as above except without contour. Ideal for right angle diffuse and thru-beam sensors. 304 Stainless Steel	<b>6161AS5297</b>
<b>Adjustable Protective Bracket</b>	
Heavy-duty bracket protects the sensor from damage. Works with all Prism Series sensors. Ideal for material handling applications with Prism right angle reflex sensors. Provides locking vertical and horizontal adjustments for independent adjustment in each axis. Sensor mounts on #4 studs. 10 ga. painted steel	<b>E58KS5200</b>
<b>Comet/Prism Ball Swivel Bracket</b>	
Allows 360° rotation and 10° vertical tilt. Hole spacing is identical to our 50 and 55 Series sensors. Ideal for mounting Right Angle sensors. Made of Noryl.	<b>6181AS5200</b>
<b>Accessories</b>	
Replacement mounting nuts and other accessories	See <b>Tab 8, sections 8.2 and 8.3</b>
<b>Connector Cables</b>	
A variety of cables, connector blocks and accessories	See <b>Tab 10, section 10.1</b>
<b>Dimensions, see Page V8-T5-76.</b>	

**Note**

<sup>①</sup> For a full selection of connector cables, see **Tab 10, section 10.1**.

## Technical Data and Specifications

### Glass Fiber Optic Adapter

Description	Specification
Sensor specifications	See Prism Series specifications below
Material of construction	Adapter: 360 brass; gasket: silicone
Vibration (sensor/adapter)	30g over 10 Hz to 2 kHz
Shock (sensor/adapter)	50g for 10 ms 1/2 sinewave pulse
Enclosure ratings	NEMA 1 <sup>①</sup>

### Prism Series Sensors

Description	AC/DC Models	DC Only Models
Input voltage	20 to 132 Vac, 50/60 Hz or 15 to 30 Vdc	10 to 30 Vdc
Power dissipation	Thru-beam: 2W maximum; All others: 1.5W maximum	Thru-beam: 1.5W maximum; All others: 1W maximum
Output type	Solid-state relay	Solid-state relay
Output isolation	400V maximum	400V maximum
Voltage switching capacity	200 Vac peak; 180 Vdc	200 Vac peak; 180 Vdc
Current switching capacity	80 mA AC load, 110 mA at 132 Vdc (derate to 100 mA at 180 Vdc)	80 mA AC load, 110 mA at 132 Vdc (derate to 100 mA at 180 Vdc)
Off-state leakage	10 $\mu$ A maximum	10 $\mu$ A maximum
On-state resistance	25 ohms maximum	25 ohms maximum
Short circuit protection	Protected (current limited) for loads less than 32 Vac or Vdc <sup>②</sup>	Protected (current limited) for loads less than 32 Vac or Vdc <sup>②</sup>
Response time	3 ms	3 ms
Light/dark operation	Specified by catalog number	Specified by catalog number
Temperature range		
Operating	-13° to 131°F (-25° to 55°C)	-13° to 131°F (-25° to 55°C)
Storage	-13° to 158°F (-25° to 70°C)	-13° to 158°F (-25° to 70°C)
Material of construction	Lens: polycarbonate; cable jacket: PVC; body: structural polyurethane foam <sup>③</sup>	Lens: polycarbonate; cable jacket: PVC; body: structural polyurethane foam <sup>③</sup>
Cable versions	2m length, 4-conductor cable; micro 4-pin male connector	2m length, 4-conductor cable; micro 4-pin male connector
Connector versions	Micro-connector 4-pin male AC or DC key (by model)	Micro-connector 4-pin male AC or DC key (by model)
Vibration and shock	Vibration: 30g over 10 Hz to 2 kHz; shock: 50g for 10 ms 1/2 sine wave pulse	Vibration: 30g over 10 Hz to 2 kHz; shock: 50g for 10 ms 1/2 sine wave pulse
LED indicator	Thru-beam source: Lights steady when power is ON; all others: Light steady when output is ON	Thru-beam source: Lights steady when power is ON; all others: Light steady when output is ON
Thru-beam alignment aid	Detector includes a visible LED behind lens that lights steady when beam is complete	Detector includes a visible LED behind lens that lights steady when beam is complete
Enclosure ratings	NEMA 1, 2, 3, 4, 4X, 6, 12 and 13 <sup>④</sup>	NEMA 1, 2, 3, 4, 4X, 6, 12 and 13 <sup>④</sup>

#### Notes

- <sup>①</sup> The adapter will resist the entrance of moisture in the area between the lenses and the fiber ends when properly assembled. However, moisture entry is possible during direct high pressure sprays. Since the Prism Series sensors are rated NEMA 1, 2, 3, 4, 4X, 6, 12 and 13, this will not result in damage to the sensors themselves.
- <sup>②</sup> **IMPORTANT:** Output will reset automatically when short is removed (there is no visual indication of a short circuit condition)
- <sup>③</sup> Do not expose to concentrated acids, alcohols or ketones.
- <sup>④</sup> Photoelectric sensors conform to NEMA tests as indicated above, however, some severe washdown applications can exceed these NEMA test specifications.

# 5.6

## Photoelectric Sensors

### Prism Series Sensors

#### Excess Gain

#### Thru-Beam Sensors

##### Thru-Beam

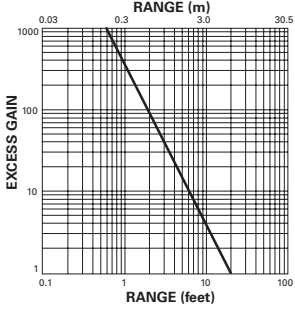

#### Reflex and Diffuse Reflective Sensors

##### Polarized Reflex (3 in diameter retroreflector)

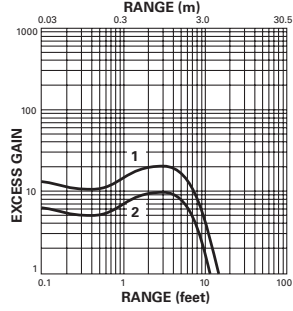

1. 14151 Typical performance
2. 14151 Minimum performance

##### Diffuse Reflective (90% reflective white card)

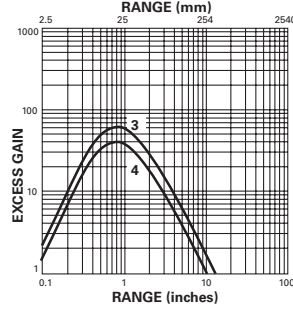

3. 13151 Typical performance
4. 13151 Minimum performance

#### Glass Fiber Optic Adapter

##### When Using Single Fibers for Thru-Beam Sensing

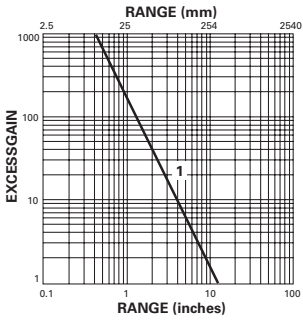

- Gain using E51KF823 fibers
1. 13150A Prism

##### When Using Duplex Fibers for Diffuse Reflective Sensing

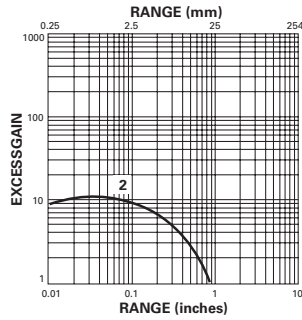

- Gain using E51KF723 fibers, based on 90% reflective white card
2. 13150A Prism

**Wiring Diagrams**

Pin numbers are for reference, rely on pin location when wiring.

**Thru-Beam Sensors**

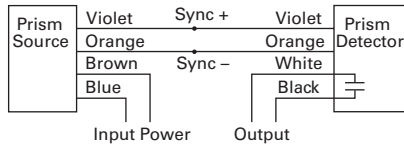

See Prism Series wiring diagrams below for details on wiring power and output.

**Prism Series Sensors**

**AC/DC Models ①②**

**All AC/DC Models (except Thru-Beam)**

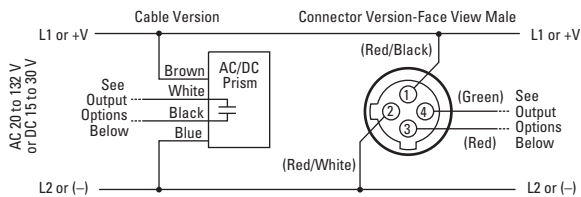

**DC Models ①②③**

**All DC Models (except Thru-Beam)**

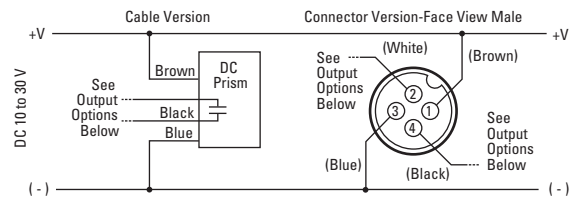

**AC/DC Thru-Beam Wiring**

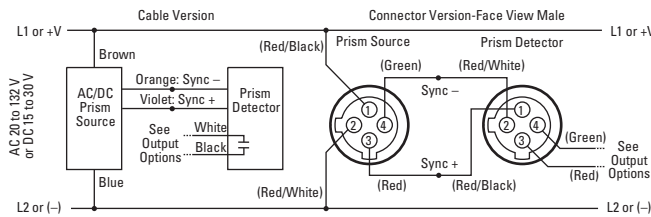

**DC Thru-Beam Wiring**

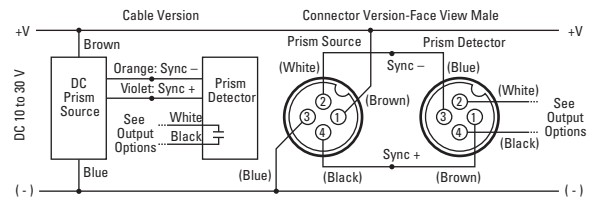

**AC/DC Isolated Output Options**

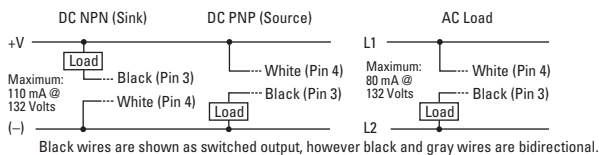

**DC Isolated Output Options**

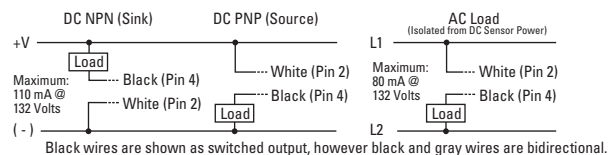

**Notes**

- ① Cable versions: The color codes are the actual wire colors emanating from the sensor.
- ② Connector versions: The pin numbering and wire colors, shown in ( ), are typical of several manufacturers, however, variations are possible. In case of discrepancies, rely on function indicated and pin location rather than pin number or wire color.
- ③ Sensor operates on DC voltage, but isolated output can switch AC or DC loads.

# 5.6

## Photoelectric Sensors

### Prism Series Sensors

#### Dimensions

Approximate dimensions in inches (mm) except where noted.

#### Sensor with Adapter Installed

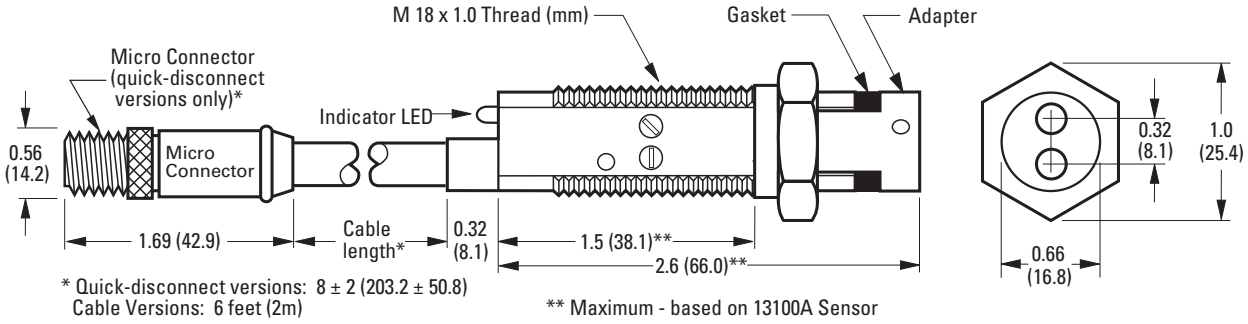

#### Reflex and Polarized Reflex Models

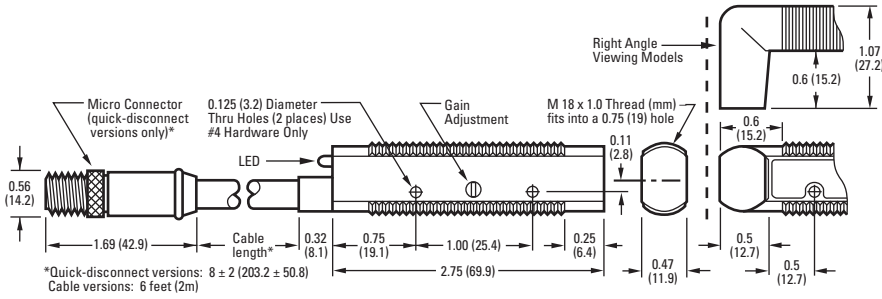

#### Diffuse Reflective and Thru-Beam Models

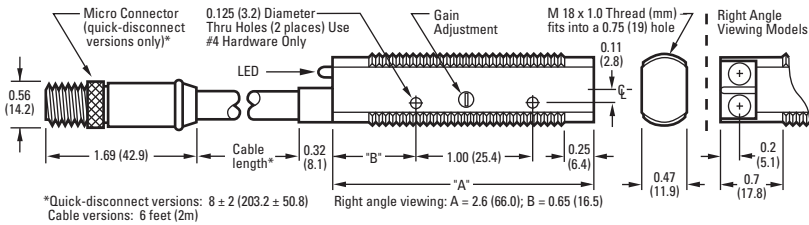

Approximate dimensions in inches (mm)

**Accessories**

**Flush Mount Bracket—6161AS5296**

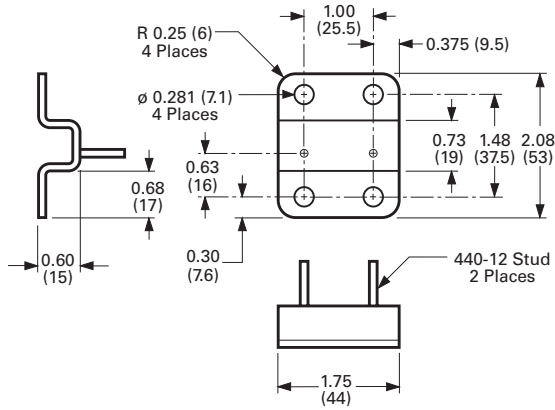

**Adjustable Protective Bracket**

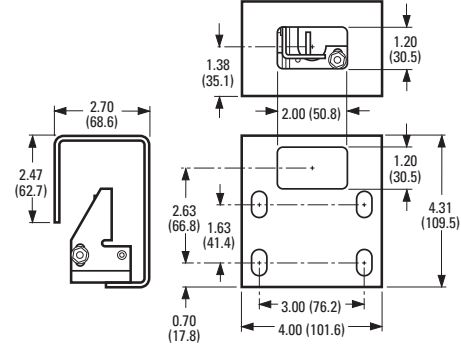

**Flush Mount Bracket—6161AS5297**

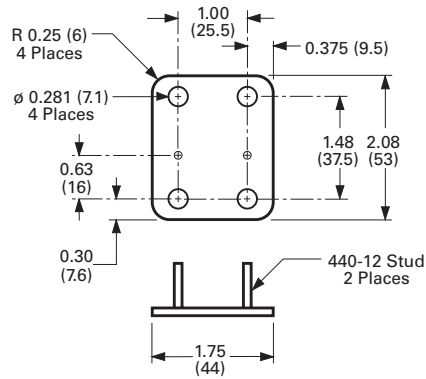

**Comet/Prism Ball Swivel Bracket**

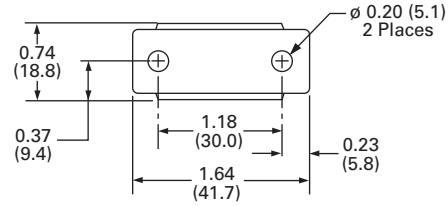

## OEM Prism Series Sensors



5

## OEM Prism Series Sensors

## Product Description

The OEM Prism Series from Eaton's Electrical Sector is very similar to our standard cost-effective Prism Series and has been optimized for high volume OEM use. In place of the isolated output found in the standard models, the OEM Prism features dual or single discrete outputs for simple wiring. In addition, OEM Prism sensors are shipped bulk packaged for easier handling by both the receiver and the installer. Forward and Right Angle viewing models feature identical gain and optical characteristics for the best fit on your machine. A gain control allows quick adjustment for peak optical performance in a variety of applications. Both diffuse reflective and polarized reflex models are available.

All models are 10–30 Vdc only to meet the rising demand for DC sensing solutions. Polarized reflex units eliminate reliability problems when sensing shiny objects. Visible red sensing beams allow you to see exactly where the sensors are aimed for easier setup. Models are available preconfigured in either light or dark operate modes.

The unique threaded body with flat sides allows quick mounting in a 3/4 in hole or against any flat surface. Internal components are rigidly sealed in a solid encapsulated package for excellent performance in high-vibration and high-shock applications.

## Contents

<b>Description</b>	<b>Page</b>
OEM Prism Series Sensors	
Product Overview .....	<b>V8-T5-70</b>
Product Selection	
OEM Prism Series Sensors .....	<b>V8-T5-79</b>
Compatible Connector Cables .....	<b>V8-T5-80</b>
Accessories .....	<b>V8-T5-80</b>
Technical Data and Specifications .....	<b>V8-T5-81</b>
Excess Gain .....	<b>V8-T5-81</b>
Wiring Diagrams .....	<b>V8-T5-82</b>
Dimensions .....	<b>V8-T5-82</b>

## Features

- Small size for use in a wide variety of applications and locations
- Sensors are shipped bulk-packaged for the convenience of high volume users
- High sensing power for longer ranges and resistance to dust and dirt
- Adjustable gain control to ensure peak optical performance
- High noise immunity, which greatly reduces problems associated with electrical noise
- NPN and PNP outputs provided in a single sensor for simple wiring
- Short circuit protection
- Quick 1.2 ms response time
- Output status LED is highly visible from a wide 300° angle
- Cable models allow for lowest cost wiring
- Micro-connector models provide for quick installation or replacement
- Custom cable length options

## Standards and Certifications

- RoHS Compliant

**DANGER**

**THIS SENSOR IS NOT A SAFETY DEVICE AND IS NOT INTENDED TO BE USED AS A SAFETY DEVICE. This sensor is designed only to detect and read certain data in an electronic manner and perform no use apart from that, specifically no safety-related use. This sensor product does not include self-checking redundant circuitry, and the failure of this sensor product could cause either an energized or de-energized output condition, which could result in death, serious bodily injury, or property damage.**

For the most current information on this product, visit our Web site: [www.eaton.com](http://www.eaton.com)

For Customer Service in the U.S. call 1-877-ETN CARE (386-2273), in Canada call 1-800-268-3578. For Application Assistance in the U.S. and Canada call 1-800-426-9184.

**Product Overview**

**Product Comparison**

Eaton’s cost-effective Prism Series, OEM Prism and premium Comet Series all share the same 18 mm flat-sided housing. This results in the largest interchangeable sensor family available, allowing you to select from well over 250 different models to solve the widest variety of sensing applications.

**Comparison**

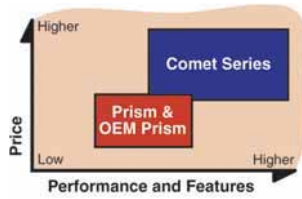



Compared to the similar-looking Comet, the OEM Prism is optimized for value, with a basic feature set best suited for OEMs.

**Product Selection**

**OEM Prism Series Sensors**

**Three-Wire and Four-Wire Sensors**

	Operating Voltage	Sensing Range	Optimum Range	Field of View	Output Type	Connection Type	Light Operate Catalog Number	Dark Operate Catalog Number
<b>Polarized Reflex Forward Viewing</b> <sup>①②</sup>								
<b>Polarized Reflex Forward Viewing</b> Sensor  Retroreflector <sup>③</sup>	10–30 Vdc	10 ft (3 m) <sup>④</sup>	0.1 to 8 ft (0.03 to 2.4 m)	3 in (76 mm) diameter at 12 ft (3.6 m)	NPN and PNP	6 ft cable	<b>14156AL17B1</b>	<b>14156AD17B1</b>
						4-pin micro DC connector	<b>14156AL07B1</b> <sup>⊕</sup>	<b>14156AD07B1</b> <sup>⊕</sup>
<b>Polarized Reflex Right Angle Viewing</b> <sup>①②</sup>								
<b>Polarized Reflex Right Angle Viewing</b> Retroreflector <sup>③</sup>  Sensor	10–30 Vdc	10 ft (3 m) <sup>④</sup>	0.1 to 8 ft (0.03 to 2.4 m)	3 in (76 mm) diameter at 12 ft (3.6 m)	NPN and PNP	6 ft cable	<b>14156RL17B1</b>	<b>14156RD17B1</b>
						4-pin micro DC connector	<b>14156RL07B1</b> <sup>⊕</sup>	<b>14156RD07B1</b> <sup>⊕</sup>
<b>Diffuse Reflective Right Angle Viewing</b> <sup>①</sup>								
<b>Diffuse Reflective Right Angle Viewing</b> 	10–30 Vdc	8 in (200 mm) <sup>⑤</sup>	0.1 to 5 in (3 to 127 mm)	2 in (51 mm) diameter at 5 in (127 mm)	NPN and PNP	6 ft cable	<b>13156RL17B1</b>	<b>13156RD17B1</b>
						4-pin micro DC connector	<b>13156RL07B1</b> <sup>⊕</sup>	<b>13156RD07B1</b> <sup>⊕</sup>
		24 in (609 mm) <sup>⑤</sup>	0.1 to 15 in (3 to 381 mm)	6 in (152 mm) diameter at 15 in (381 mm)	NPN and PNP	6 ft cable	<b>13157RL17B1</b>	<b>13157RD17B1</b>
						4-pin micro DC connector	<b>13157RL07B1</b> <sup>⊕</sup>	<b>13157RD07B1</b> <sup>⊕</sup>

**Notes**

- ⊕ See listing of compatible connector cables on **Page V8-T5-80**.
- ① Contact factory for approval status.
- ② For a complete system, order sensor and retroreflector (see **Tab 8, section 8.1**).
- ③ Retroreflector not included.
- ④ Ranges based on a 3 in diameter retroreflector.
- ⑤ Sensor will detect a 90% reflectance white card at this range.



# 5.7

## Photoelectric Sensors

### OEM Prism Series Sensors

#### Compatible Connector Cables

Micro-Style,  
Straight Female

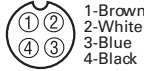

#### Standard Cables—Micro <sup>①</sup>

Voltage Style	Number of Pins	Gauge	Length	Pin Configuration/ Wire Colors (Face View Female Shown)	PVC Jacket Catalog Number	PUR Jacket Catalog Number	IRR PUR Jacket Catalog Number
<b>Micro-Style, Straight Female</b>							
DC	4-pin, 4-wire	22 AWG	6 ft (2 m)	 1-Brown 2-White 3-Blue 4-Black	CSDS4A4CY2202	CSDS4A4RY2202	CSDS4A4IO2202

5

#### Accessories

#### OEM Prism Series Sensors

Description	Catalog Number
<b>Retroreflectors</b>	
Retroreflectors and retroreflective tape	See <b>Tab 8, section 8.1</b>
<b>Mounting Brackets</b>	
A wide variety of mounting brackets for tubular sensors	See <b>Tab 8, section 8.2</b>
<b>Flush Mount Bracket</b>	
Contoured design is ideal for flush mounting of right angle OEM Prism Series polarized reflex to mounting surface using 1/4 in hardware. No alignment adjustment. Sensor mounts on #4 studs. 304 stainless steel	<b>6161AS5296</b>
<b>Flush Mount Bracket</b>	
Same as above except without contour. Ideal for right angle diffuse sensors. 304 stainless steel	<b>6161AS5297</b>
<b>Adjustable Protective Bracket</b>	
Heavy-duty bracket protects the sensor from damage. Works with all OEM Prism Series sensors. Ideal for material handling applications with the OEM Prism Series right angle polarized reflex sensor. Provides locking vertical and horizontal adjustments for independent adjustment in each axis. Sensor mounts on #4 studs. 10 ga. painted steel	<b>E58KS5200</b>
<b>Comet/Prism Ball Swivel Bracket</b>	
Allows 360° rotation and 10° vertical tilt. Hole spacing is identical to our 50 and 55 Series sensors. Ideal for mounting Right Angle sensors. Made of Noryl.	<b>6181AS5200</b>
<b>Accessories</b>	
Replacement mounting nuts and other accessories	See <b>Tab 8, sections 8.2 and 8.3</b>
<b>Connector Cables</b>	
A variety of cables, connector blocks and accessories	See <b>Tab 10, section 10.1</b>
<b>Dimensions, see Page V8-T5-77.</b>	

#### Note

<sup>①</sup> For a full selection of connector cables, see **Tab 10, section 10.1**.

**Technical Data and Specifications**

**OEM Prism Series Sensors**

Description	DC Only Models
Input voltage	10 to 30 Vdc
Power dissipation	1W maximum
Output type	NPN and PNP
Current switching capacity	100 mA maximum
OFF-state leakage	10 $\mu$ A maximum
ON-state voltage drop	NPN: 2.0V at 100 mA; PNP: 2.5V at 100 mA
Short circuit protection	Sensor will turn off immediately when short or overload is detected (indicator LED flashes). Sensor will reset when short is removed.
Response time	1.2 ms
Light/dark operation	Specified by catalog number
Temperature range	
Operating	-13° to 131°F (-25° to 55°C)
Storage	-13° to 158°F (-25° to 70°C)
Sunlight immunity	1000 ft-candles
Material of construction	Lens: polycarbonate; cable jacket: PVC; body: structural polyurethane foam (do not expose to concentrated acids, alcohols or ketones)
Cable versions	2m length; 4 conductor cable
Connector versions	Micro-connector, 4-pin male, DC key, on nominal 8 in pigtail
Vibration and shock	Vibration: 30g over 10 Hz to 2 kHz; shock: 50g for 10 ms 1/2 sine wave pulse
Indicator LED	Lights steady when output is ON; OFF when output is OFF; OFF when output is in short circuit mode
Enclosure ratings	NEMA 1, 2, 3, 4, 4X, 6, 12 and 13 <sup>Ⓢ</sup>

**Excess Gain**

**Polarized Reflex (3 in diameter retroreflector)**

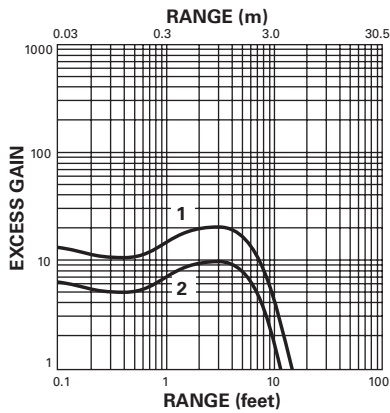

- 1. 14156 Typical performance
- 2. 14156 Minimum performance

**Diffuse Reflective (90% reflective white card)**

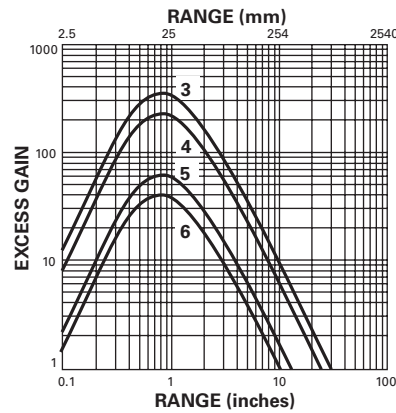

- 3. 13157 Typical performance
- 4. 13157 Minimum performance
- 5. 13156 Typical performance
- 6. 13156 Minimum performance

**Note**

<sup>Ⓢ</sup> Photoelectric sensors conform to NEMA tests as indicated above, however, some severe washdown applications can exceed these NEMA test specifications.

# 5.7

## Photoelectric Sensors

### OEM Prism Series Sensors

#### Wiring Diagrams

Pin numbers are for reference, rely on pin location when wiring.

#### OEM Prism Series Sensors

Operating Voltage	Output	Cable Models	Micro-Connector Models (Face View Male Shown)
<b>Four-Wire Sensors</b>			
10–30 Vdc	NPN and PNP		

5

#### Dimensions

Approximate dimensions in inches (mm) except where noted.

#### Polarized Reflex Models

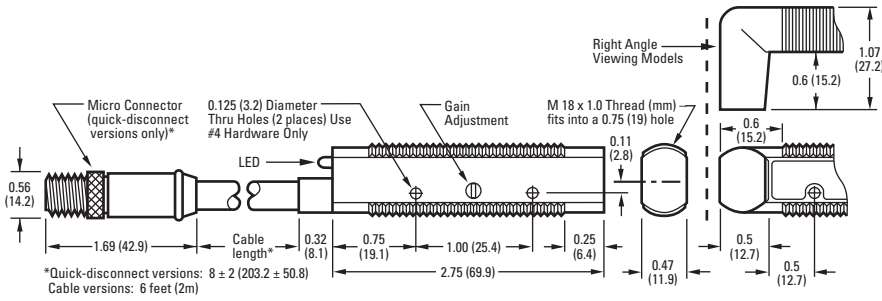

#### Diffuse Reflective Models

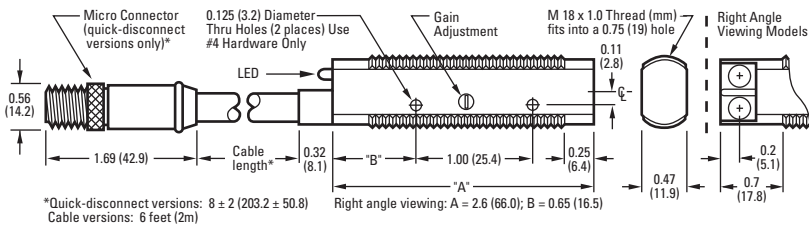

Approximate dimensions in inches (mm)

**Accessories**

**Flush Mount Bracket—6161AS5296**

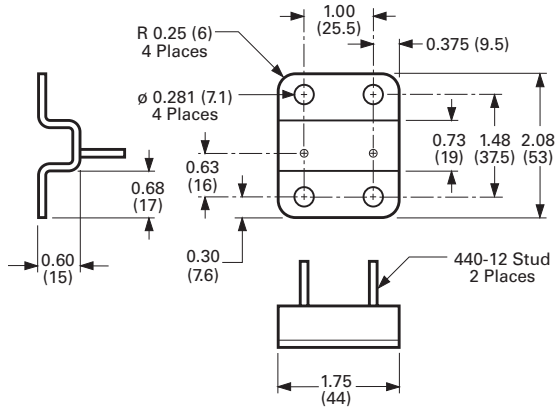

**Adjustable Protective Bracket**

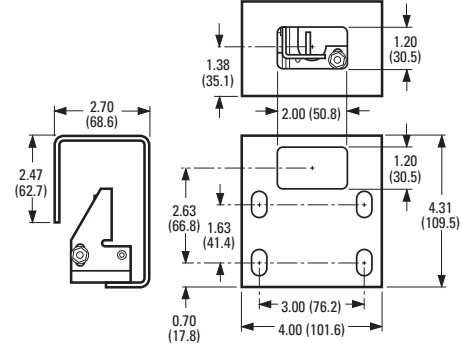

**Flush Mount Bracket—6161AS5297**

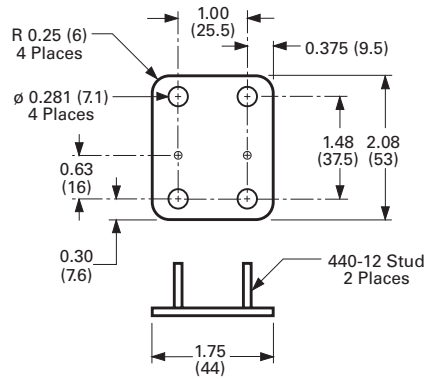

**Comet/Prism Ball Swivel Bracket**

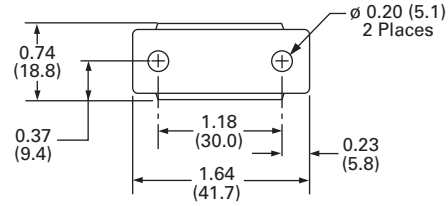

E58 Harsh Duty Series Sensors



5

### E58 Harsh Duty Series Sensors

#### Product Description

The E58 Harsh Duty Series by Eaton's Electrical Sector was designed to withstand your harshest physical, chemical and optical environments.

Extensive research dictated the choice of materials used in this sensor. Stainless steel, PVDF and tempered glass components are mechanically assembled using Viton® seals to ensure complete sealing and resistance to industry chemicals. All adhesives and potting subject to failure from chemical attack have been eliminated from the design. The result is a sensor highly resistant to chemical attack and moisture intrusion, that can withstand heavy shock and vibration in almost any application.

E58 Harsh Duty sensors feature unparalleled optical performance. They are ideal for automotive applications where exposure to lubricants, cutting fluids, coolants and glycols is common. For food processing applications, a smooth body version simplifies high-pressure chemical washdowns, and withstands the use of sanitizers, surfactants, and cleaning agents including diluted bases and acids.

#### Features

- Sensors are available in 18 mm and 30 mm diameters
- Highly refined optics for long sensing ranges and to see through high levels of contamination—unmatched optical performance
- Perfect Prox technology provides exceptional background rejection and extremely high excess gain

### Contents

<i>Description</i>	<i>Page</i>
E58 Harsh Duty Series Sensors	
Product Overview .....	<b>V8-T5-85</b>
Product Selection	
Thru-Beam and Reflex Sensors .....	<b>V8-T5-86</b>
Perfect Prox Background Rejection Sensors .....	<b>V8-T5-87</b>
Compatible Connector Cables .....	<b>V8-T5-88</b>
Accessories .....	<b>V8-T5-88</b>
Options .....	<b>V8-T5-89</b>
Technical Data and Specifications .....	<b>V8-T5-90</b>
Excess Gain .....	<b>V8-T5-91</b>
Wiring Diagrams .....	<b>V8-T5-91</b>
Dimensions .....	<b>V8-T5-92</b>

- Resistant to the wide range of chemicals used in the automotive, food processing and forest products industries
- Suitable for high temperature, high pressure washdown (1200 psi)
- Mechanical Viton seals hold up to extreme temperature variations
- Visible sensing beam on all models lets you see where the beam is aimed for quick setup and alignment
- Output status indicator is the brightest available and is visible from any angle and in any lighting condition
- The industry's only background rejection sensors with a two-wire circuit design
- Models available with both AC and DC operation in a single unit
- Four-wire DC sensors offer dual NPN and PNP outputs

#### Standards and Certifications

- UL Listed, E166051
- UL tested to Canadian safety standards
- CE (DC models only)
- RoHS Compliant



#### **⚠ DANGER**

**THIS SENSOR IS NOT A SAFETY DEVICE AND IS NOT INTENDED TO BE USED AS A SAFETY DEVICE. This sensor is designed only to detect and read certain data in an electronic manner and perform no use apart from that, specifically no safety-related use. This sensor product does not include self-checking redundant circuitry, and the failure of this sensor product could cause either an energized or de-energized output condition, which could result in death, serious bodily injury, or property damage.**

For the most current information on this product, visit our Web site: [www.eaton.com](http://www.eaton.com)

For Customer Service in the U.S. call 1-877-ETN CARE (386-2273), in Canada call 1-800-268-3578. For Application Assistance in the U.S. and Canada call 1-800-426-9184.

**Product Overview**

**E58 Harsh Duty Series Sensors Physical Attributes**

**Rugged physical construction**

The E58 Harsh Duty Series was designed from the ground up to be the most rugged sensor family available. The strong metal housing, mechanical seals and surface mount electronics withstand heavy shock and vibration. The tempered glass lens cover provides protection in abrasive environments, and the sturdy cable is physically clamped to the sensor body.

**Exceptional environmental protection and chemical resistance**

The E58 Harsh Duty Series was designed to be used in the automotive, food processing and forest products industries. It is also well suited for applications in related industries such as pulp and paper, car wash and steel. These industries are all physically demanding on equipment and that’s why we designed and tested these sensors to extreme levels of shock and vibration.

Many sensor failures, however, are actually due to chemical attack so we had to make them stand up to constant chemical exposure—day in and day out. To ensure resistance to the widest possible range of chemicals, we conducted extensive studies of the chemical agents commonly used in these industries.

We then selected only those materials that could withstand exposure to these chemicals without failure in the design of the E58 Harsh Duty Series. In addition, we eliminated adhesives in favor of more reliable Viton compression seals. Some of the more common chemicals against which this sensor has been tested are listed in the resistance chart.

This resistance chart reflects testing of the 303 stainless steel body used on the standard E58 Harsh Duty Series sensors. Additional chemical resistance for food industry applications is available using sensors with the optional 316 stainless steel body and hard-coated polycarbonate (or acrylic on reflex models) lens cover.

The E58 Harsh Duty Series was designed to resist the chemicals shown in this table under normal use and conditions. Extremes of environmental factors such as temperature, pressure, concentration, duration of exposure, ultraviolet sunlight and chemical interactions combined with the presence of these chemicals could result in premature material failure. For these cases, testing the sensor in the specific application is recommended.

**E58 Harsh Duty Series Sensors Chemical Resistance Chart**

Chemical Category	Commonly Found In
Oils, cutting fluids, aqueous coolants	Automotive, forest industry
Vegetable and mineral oil	Automotive, forest industry
Surfactants	Automotive, food processing
Dilute acids	Food processing
Dilute bases	Food processing
Sanitizers	Food processing

**Sensing Modes**

**Perfect Prox**

This is a unique type of diffuse reflective sensor that combines extremely high sensing power (called “excess gain”) with a sharp optical cutoff to ignore backgrounds. This allows the sensor to reliably detect targets regardless of variations in color, reflectance, contrast or surface shape, while ignoring objects just slightly outside the target range. With Perfect Prox, the E58 Harsh Duty Series can act just like an inductive prox sensor—but with up to 20 times the range for mounting away from a moving target so you can avoid damage and downtime. 18 mm and 30 mm sizes, two-, three- and four-wire circuits, and cable, micro- and mini-connector terminations mean quick and easy replacement of damaged proximity sensors. A visible sensing beam lets you quickly confirm the sensor is aligned correctly in the application.

The 18 mm Perfect Prox has a sensing range of 2 or 4 in (50 or 100 mm), and the 30 mm version has a range of 6 or 11 in (150 or 280 mm).

This simplified application example shows the power of the Perfect Prox.

**Application Example**

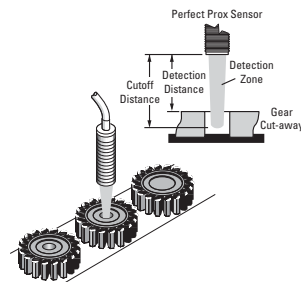

If the hole is present in the gear, the sensor will shine through the hole and ignore the belt—no detection event will occur.



If the hole in the gear is missing, the sensor will detect the surface of the gear and reject the part.

#### Product Selection

#### Thru-Beam and Reflex Sensors

5

#### Three-Wire and Four-Wire Sensors

	Operating Voltage	Sensing Range	Optimum Range	Field of View	Thru-Beam Component	Connection Type	Light Operate Catalog Number	Dark Operate Catalog Number
<b>30 mm Diameter Thru-Beam</b> <sup>①</sup>								
<b>30 mm Diameter Thru-Beam</b> Source  Detector	20–132 Vac 50/60 Hz or 15–30 Vdc	800 ft (250 m)	0.1 to 300 ft (0.03 to 90 m)	33 in (830 mm) diameter at 25 ft (7.6 m)	Source	2m cable	<b>E58-30TS250-GA</b>	—
						4-pin micro AC connector	<b>E58-30TS250-GAP</b> <sup>⊕</sup>	—
					Detector	2m cable	<b>E58-30TD250-GL</b>	<b>E58-30TD250-GD</b>
						4-pin micro AC connector	<b>E58-30TD250-GLP</b> <sup>⊕</sup>	<b>E58-30TD250-GDP</b> <sup>⊕</sup>
<b>30 mm Diameter Reflex</b> Sensor  Retroreflector <sup>③</sup>	20–132 Vac 50/60 Hz or 15–30 Vdc	59 ft (18 m)	1 to 40 ft (0.03 to 12 m)	6 in (150 mm) diameter at 20 ft (6 m)	—	2m cable	<b>E58-30RS18-GL</b>	<b>E58-30RS18-GD</b>
						4-pin micro AC connector	<b>E58-30RS18-GLP</b> <sup>⊕</sup>	<b>E58-30RS18-GDP</b> <sup>⊕</sup>
					—	2m cable	<b>E58-30RS18-HL</b>	<b>E58-30RS18-HD</b>
						4-pin micro DC connector	<b>E58-30RS18-HLP</b> <sup>⊕</sup>	<b>E58-30RS18-HDP</b> <sup>⊕</sup>
<b>30 mm Diameter Polarized Reflex</b> <sup>②</sup>								
<b>30 mm Diameter Polarized Reflex</b> Retroreflector <sup>③</sup>	20–132 Vac 50/60 Hz or 15–30 Vdc	34 ft (10 m)	1 to 20 ft (0.03 to 6 m)	6 in (150 mm) diameter at 20 ft (6 m)	—	2m cable	<b>E58-30RP10-GL</b>	<b>E58-30RP10-GD</b>
						4-pin micro AC connector	<b>E58-30RP10-GLP</b> <sup>⊕</sup>	<b>E58-30RP10-GDP</b> <sup>⊕</sup>
					—	2m cable	<b>E58-30RP10-HL</b>	<b>E58-30RP10-HD</b>
						4-pin micro DC connector	<b>E58-30RP10-HLP</b> <sup>⊕</sup>	<b>E58-30RP10-HDP</b> <sup>⊕</sup>

Options, see Page V8-T5-89.

#### Notes

- ⊕ See listing of compatible connector cables on Page V8-T5-88.
- ① For a complete system, order one source and one detector.
- ② For a complete system, order sensor and retroreflector (see Tab 8, section 8.1).
- ③ Retroreflector not included.

**Perfect Prox Background Rejection Sensors**

**Two-Wire Sensors**



Operating Voltage	Nominal Range ①	Optimum Range	Cutoff Range ②	Field of View	Connection Type	Light Operate Catalog Number	Dark Operate Catalog Number
<b>18 mm Diameter Perfect Prox</b>							
90–132 Vac 50/60 Hz or 18–50 Vdc	2 in (50 mm)	0.4 to 1.8 in (10 to 45 mm)	2.25 in (57 mm) and beyond	0.25 in (6 mm) diameter at 2 in (50 mm)	2m cable	<b>E58–18DP50-EL</b>	<b>E58–18DP50-ED</b>
					3-pin micro AC connector	<b>E58–18DP50-ELP</b> ☺	<b>E58–18DP50-EDP</b> ☺
					3-pin mini-connector	<b>E58–18DP50-ELPB</b> ☺	<b>E58–18DP50-EDPB</b> ☺
	4 in (100 mm)	0.5 to 3 in (13 to 76 mm)	5 in (127 mm) and beyond	0.38 in (10 mm) diameter at 4 in (100 mm)	2m cable	<b>E58–18DP100-EL</b>	<b>E58–18DP100-ED</b>
					3-pin micro AC connector	<b>E58–18DP100-ELP</b> ☺	<b>E58–18DP100-EDP</b> ☺
					3-pin mini-connector	<b>E58–18DP100-ELPB</b> ☺	<b>E58–18DP100-EDPB</b> ☺
18–50 Vdc	2 in (50 mm)	0.4 to 1.8 in (10 to 45 mm)	2.25 in (57 mm) and beyond	0.25 in (6 mm) diameter at 2 in (50 mm)	4-pin micro DC connector	<b>E58–18DP50-DLP</b> ☺	<b>E58–18DP50-DDP</b> ☺
					4 in (100 mm)	0.5 to 3 in (13 to 76 mm)	5 in (127 mm) and beyond



Operating Voltage	Nominal Range ①	Optimum Range	Cutoff Range ②	Field of View	Connection Type	Light Operate Catalog Number	Dark Operate Catalog Number
<b>30 mm Diameter Perfect Prox</b>							
90–132 Vac 50/60 Hz or 18–50 Vdc	6 in (150 mm)	1 to 6 in (26 to 150 mm)	6.5 in (165 mm) and beyond	0.75 in (19 mm) diameter at 6 in (150 mm)	2m cable	<b>E58–30DP150-EL</b>	<b>E58–30DP150-ED</b>
					3-pin micro AC connector	<b>E58–30DP150-ELP</b> ☺	<b>E58–30DP150-EDP</b> ☺
					3-pin mini-connector	<b>E58–30DP150-ELPB</b> ☺	<b>E58–30DP150-EDPB</b> ☺
	11 in (280 mm)	1 to 9 in (26 to 228 mm)	12.5 in (318 mm)	1.0 in (26 mm) diameter at 11 in (280 mm)	2m cable	<b>E58–30DPS280-EL</b>	<b>E58–30DPS280-ED</b>
					3-pin micro AC connector	<b>E58–30DPS280-ELP</b> ☺	<b>E58–30DPS280-EDP</b> ☺
					3-pin mini-connector	<b>E58–30DPS280-ELPB</b> ☺	<b>E58–30DPS280-EDPB</b> ☺
18–50 Vdc	6 in (150 mm)	1 to 6 in (26 to 150 mm)	6.5 in (165 mm) and beyond	0.75 in (19 mm) diameter at 6 in (150 mm)	4-pin micro DC connector	<b>E58–30DP150-DLP</b> ☺	<b>E58–30DP150-DDP</b> ☺

Options, see Page V8-T5-89.

**Three-Wire and Four-Wire Sensors**



Operating Voltage	Nominal Range ①	Optimum Range	Cutoff Range ②	Field of View	Connection Type	Light Operate Catalog Number	Dark Operate Catalog Number
<b>18 mm Diameter Perfect Prox</b>							
10–30 Vdc	2 in (50 mm)	0.4 to 1.8 in (10 to 45 mm)	2.25 in (57 mm) and beyond	0.25 in (6 mm) diameter at 2 in (50 mm)	2m cable	<b>E58–18DP50-HL</b>	<b>E58–18DP50-HD</b>
					4-pin micro DC connector	<b>E58–18DP50-HLP</b> ☺	<b>E58–18DP50-HDP</b> ☺
	4 in (100 mm)	0.5 to 3 in (13 to 76 mm)	5 in (127 mm) and beyond	0.38 in (10 mm) diameter at 4 in (100 mm)	2m cable	<b>E58–18DP100-HL</b>	<b>E58–18DP100-HD</b>
					4-pin micro DC connector	<b>E58–18DP100-HLP</b> ☺	<b>E58–18DP100-HDP</b> ☺



Operating Voltage	Nominal Range ①	Optimum Range	Cutoff Range ②	Field of View	Connection Type	Light Operate Catalog Number	Dark Operate Catalog Number
<b>30 mm Diameter Perfect Prox</b>							
20–132 Vac 50/60 Hz or 15–30 Vdc	6 in (150 mm)	1 to 6 in (26 to 150 mm)	6.5 in (165 mm) and beyond	0.75 in (19 mm) diameter at 6 in (150 mm)	2m cable	<b>E58–30DP150-GL</b>	<b>E58–30DP150-GD</b>
					4-pin micro AC connector	<b>E58–30DP150-GLP</b> ☺	<b>E58–30DP150-GDP</b> ☺
	11 in (280 mm)	1 to 9 in (26 to 228 mm)	12.5 in (318 mm)	1.0 in (26 mm) diameter at 11 in (280 mm)	2m cable	<b>E58–30DPS280-GL</b> ☺	<b>E58–30DPS280-GD</b> ☺
					4-pin micro AC connector	<b>E58–30DPS280-GLP</b> ☺	<b>E58–30DPS280-GDP</b> ☺
10–30 Vdc	6 in (150 mm)	1 to 6 in (26 to 150 mm)	6.5 in (165 mm) and beyond	0.75 in (19 mm) diameter at 6 in (150 mm)	2m cable	<b>E58–30DP150-HL</b>	<b>E58–30DP150-HD</b>
					4-pin micro DC connector	<b>E58–30DP150-HLP</b> ☺	<b>E58–30DP150-HDP</b> ☺
	11 in (280 mm)	1 to 9 in (26 to 228 mm)	12.5 in (318 mm)	1.0 in (26 mm) diameter at 11 in (280 mm)	2m cable	<b>E58–30DPS280-HL</b>	<b>E58–30DPS280-HD</b>
					4-pin micro DC connector	<b>E58–30DPS280-HLP</b> ☺	<b>E58–30DPS280-HDP</b> ☺

Options, see Page V8-T5-89.

**Notes**

☺ ☺ See listing of compatible connector cables on Page V8-T5-88.

① Sensor will detect a 90% reflectance card at this range.

② Sensor will ignore a 90% reflectance card at this range.



# 5.8

## Photoelectric Sensors



### E58 Harsh Duty Series Sensors

#### Compatible Connector Cables

Micro-Style,  
Straight Female



#### Standard Cables—Micro<sup>①</sup>

Voltage Style	Number of Pins	Gauge	Length	Pin Configuration/ Wire Colors (Face View Female Shown)	PVC Jacket Catalog Number	PUR Jacket Catalog Number	IRR PUR Jacket Catalog Number
<b>Micro-Style, Straight Female</b>							
AC	3-pin, 3-wire	22 AWG	6 ft (2 m)	 1-Green 2-Red/Black 3-Red/White	CSAS3F3CY2202	CSAS3F3RY2202	—
	4-pin, 4-wire	22 AWG	6 ft (2 m)	 1-Red/Black 2-Red/White 3-Red 4-Green	CSAS4F4CY2202	CSAS4F4RY2202	CSAS4F4IO2202
DC	4-pin, 4-wire	22 AWG	6 ft (2 m)	 1-Brown 2-White 3-Blue 4-Black	CSDS4A4CY2202	CSDS4A4RY2202	CSDS4A4IO2202

5

Mini-Style,  
Straight Female



#### Standard Cables—Mini<sup>①</sup>

Current Rating at 600V	Voltage Style	Number of Pins	Gauge	Length	Pin Configuration/ Wire Colors (Face View Female Shown)	Catalog Number
<b>Mini-Style, Straight Female</b>						
13A	—	3-pin	16 AWG	6 ft (2 m)	 1-Green 2-Black 3-White	CSMS3F3CY1602

#### Accessories

#### E58 Harsh Duty Series Sensors

Description	Reference
Retroreflectors and retroreflective tape	See <b>Tab 8, section 8.1</b>
Mounting brackets	See <b>Tab 8, section 8.2</b>
Mounting nuts and other accessories	See <b>Tab 8, section 8.3</b>
Connector cables	See <b>Tab 10, section 10.1</b>

#### Note

<sup>①</sup> For a full selection of connector cables, see **Tab 10, section 10.1**.

## Options

Sensor options are built-to-order, contact Eaton's Sensor Applications Department at 1-800-426-9184 for delivery lead times.

### ***Thru-Beam and Reflex Sensors***

#### **Thru-Beam Apertured Versions**

Reduces effective sensing beam to 0.2 x 0.9 in (5 x 23 mm) for accurate edge detection or sensing smaller objects. Factory installed behind lens cover for protection and sealing. Sensing range is reduced to 230 ft (70 m).

To order, substitute "**070**" in place of "**250**" in source or detector catalog number.

*Example:*  
E58-30TS**070**-GA

#### **Food Processing Versions with Threaded Housings**

Upgrade to a 316 stainless steel threaded body from 303, and change the lens cover to hard-coated polycarbonate (cast acrylic for reflex models) from glass.

To order, add the suffix "**-FC**" to the end of the catalog number.

*Example:*  
E58-30RP10-GL-**FC**

#### **Food Processing Versions with Smooth (Non-Threaded) Housings**

Upgrade to a 316 stainless steel smooth (non-threaded) body from 303, and change the lens cover to hard-coated polycarbonate (cast acrylic for reflex models) from glass.

To order, add the suffix "**-FSC**" to the end of the catalog number.

*Example:*  
E58-30RP10-GL-**FSC**

### ***Perfect Prox 30 mm Diameter Model Sensors Only***

#### **Food Processing Versions with Threaded Housings**

Upgrade to a 316 stainless steel threaded body from 303, and change the lens cover to hard-coated polycarbonate from glass.

To order, add the suffix "**-FC**" to the end of the catalog number.

*Example:*  
E58-30DP150-EL-**FC**

#### **Food Processing Versions with Smooth (Non-Threaded) Housings**

Upgrade to a 316 stainless steel smooth (non-threaded) body from 303, and change the lens cover to hard-coated polycarbonate from glass.

To order, add the suffix "**-FSC**" to the end of the catalog number.

*Example:*  
E58-30DP150-EL-**FSC**

## Technical Data and Specifications

### E58 Harsh Duty Series Sensors

Description	Three-Wire and Four-Wire Sensors			Two-Wire Sensors	
	AC/DC Models (AC Operation)	AC/DC Models (DC Operation)	DC Only Models	AC/DC Models (AC Operation)	DC Only and AC/DC Models (DC Operation)
Input voltage	20–132 Vac, 50/60 Hz	15–30 Vdc	10–30 Vdc	90–132 Vac, 50/60 Hz	18–50 Vdc
Power dissipation	3W maximum	3W maximum	2W maximum	3W maximum	3W maximum
Output type	VMOS (bi-directional)	NPN (sink)	Four-wire: NPN and PNP (dual outputs)	18 mm models: DMOS/bipolar; 30 mm models: DMOS	18 mm models: DMOS/bipolar; 30 mm models: DMOS
Current switching	300 mA maximum	300 mA maximum	PNP: 100 mA max. NPN: 18 mm models: 250 mA max.; 30 mm models: 100 mA max.	18 mm models: 100 mA; 30 mm models: 300 mA	18 mm models: 100 mA; 30 mm models: 300 mA
Voltage switching	186V peak maximum	186V peak maximum	30 Vdc maximum	186V peak maximum	50 Vdc maximum
OFF-state leakage	250 $\mu$ A typical; 500 $\mu$ A maximum	250 $\mu$ A typical; 500 $\mu$ A maximum	10 $\mu$ A maximum	1.7 mA maximum	18 mm models: 1.7 mA max. 30 mm models: 1.5 mA max.
Surge current	2A maximum	2A maximum	1A maximum	1A AC	1A DC
ON-state voltage drop	—	1.8V at 10 mA 4.0V at 300 mA	NPN: 1.2V at 10 mA; 18 mm models: 2.0V at 100 mA; 30 mm models: 2.0V at 250 mA; PNP: 2.8V at 100 mA	10 Vac rms	18 mm models: 10 Vdc 30 mm models: 8 Vdc
Response time	10 ms	2 ms	18 mm models: 1 ms; 30 mm models: 1.6 ms	35 ms	35 ms
Short circuit protection	Sensor will turn off immediately when a short or overload is detected (indicator LED will flash) ①	Sensor will turn off immediately when a short or overload is detected (indicator LED will flash) ①	Sensor will turn off immediately when a short or overload is detected (indicator LED will flash) ①	Auto reset	Auto reset
Operating and storage temperature range	–40° to 131°F (–40° to 55°C)	–40° to 131°F (–40° to 55°C)	–40° to 131°F (–40° to 55°C)	18 mm models: –40° to 158°F (–40° to 70°C) 30 mm models: –10° to 131°F (–25° to 55°C)	18 mm models: –40° to 158°F (–40° to 70°C) 30 mm models: –10° to 131°F (–25° to 55°C)

Description	All Models
Enclosure material	Cable jacket: PVC (poly vinyl chloride) Indicator ring: PVDF (high-density fluorinated polymer) Seals: Viton (registered trademark of Dupont) Lens cover: Thru-beam and Perfect Prox models: Tempered glass (or hard-coated polycarbonate for models ending in <b>FC</b> or <b>FSC</b> ) Polarized reflex models: Glass (or cast acrylic for models ending in <b>FC</b> or <b>FSC</b> ) Body: 303 stainless steel (or 316 stainless steel for models ending in <b>FC</b> or <b>FSC</b> )
Cable versions	2m cable length
Connector versions	Male mini- and micro-connectors on 7 in pigtail (refer to model selection for number of pins per model)
Vibration and shock	Vibration: 30g over 20 Hz to 2 kHz; shock: 100g for 3 ms 1/2 sinewave pulse
Indicator LED	Thru-beam source: Lights when power is ON; all other models: Lights steady when output is ON, flashes when short circuit protection is in latch condition (except two-wire models)
Sunlight immunity	Perfect Prox 5000 ft-candles others: 10,000 ft-candles
Enclosure ratings	NEMA 1, 2, 3, 3R, 3S, 4, 4X, 6, 6P, 12, 12K and 13 (IP69); This product is suitable for high temperature, high pressure washdown (1200 psi).
Chemical resistance	This product was designed to withstand chemicals commonly used in the automotive, machine tool, food processing and forest industries.

#### Note

① Turn power OFF and back ON to reset. Sensor will reset when short is removed.

### Excess Gain

#### Thru-Beam, Reflex and Polarized Reflex Sensors

##### All Models

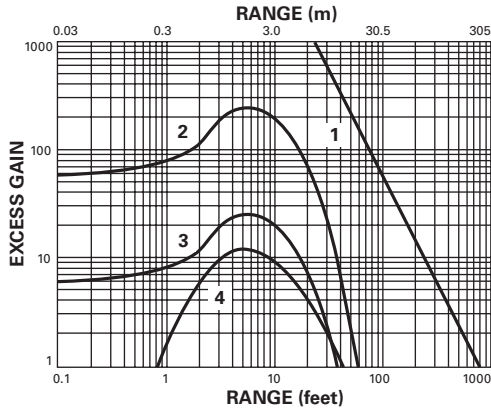

#### Thru-Beam

1. Thru-beam

#### Reflex

2. Performance to 3 in retroreflector

#### Polarized Reflex

3. Performance to 3 in retroreflector
4. Performance to corner-cube retroreflective tape

#### Perfect Prox Background Rejection Sensors

##### All Models

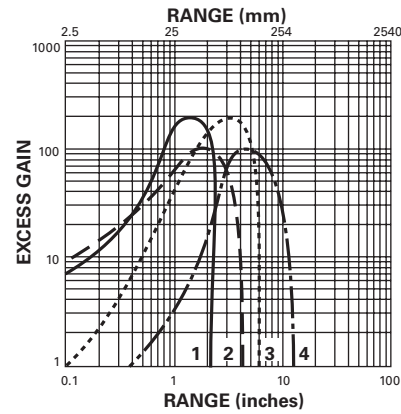

#### Perfect Prox

1. 18 mm diameter, 2 in (50 mm) range models
2. 18 mm diameter, 4 in (100 mm) range models
3. 30 mm diameter, 6 in (150 mm) range models
4. 30 mm diameter, 11 in (280 mm) range models

### Wiring Diagrams

Pin numbers are for reference, rely on pin location when wiring.

#### Perfect Prox Background Rejection Sensors

Operating Voltage	Mode/Output	Cable Models	Connector Models (Face View Male Shown)	
			Micro	Mini
<b>Two-Wire Sensors</b>				
90–132 Vac 50/60 Hz or 18–50 Vdc	All	<p>BN — L1 or +V BU — Load — L2 or (-)</p>	<p>L2 or (-) — (3) (2) — L1 or +V (1)</p>	<p>L1 or +V — (1) — L2 or (-) (2) (3) — Load</p>
18–50 Vdc	All (NPN)	<p>BN — Load — +V BU — (-)</p>	<p>(-) — (2) (1) — Load — +V (3) (4)</p>	—
	All (PNP)	<p>BN — +V BU — Load — (-)</p>	<p>(-) — Load — (2) (1) — +V (3) (4)</p>	—

# 5.8

## Photoelectric Sensors

### E58 Harsh Duty Series Sensors

Pin numbers are for reference, rely on pin location when wiring.

#### E58 Harsh Duty Series Sensors

Operating Voltage	Mode/Output	Cable Models	Micro-Connector Models (Face View Male Shown)
<b>Three-Wire and Four-Wire Sensors</b>			
20–132 Vac 50/60 Hz or 15–30 Vdc	Thru-beam source		
	All others		
10–30 Vdc	Thru-beam source		
	All others (NPN and PNP)		

#### Dimensions

Approximate dimensions in inches (mm) except where noted.

#### 18 mm Diameter (Threaded Model Shown)

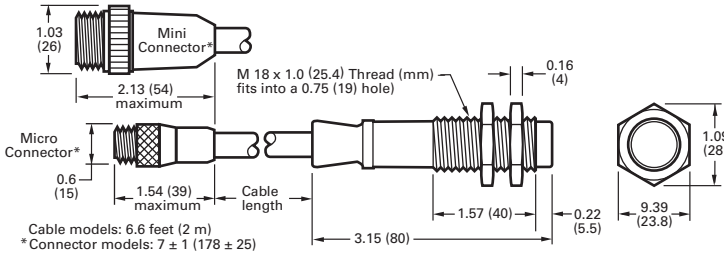

#### 30 mm Diameter (Threaded Model Shown)

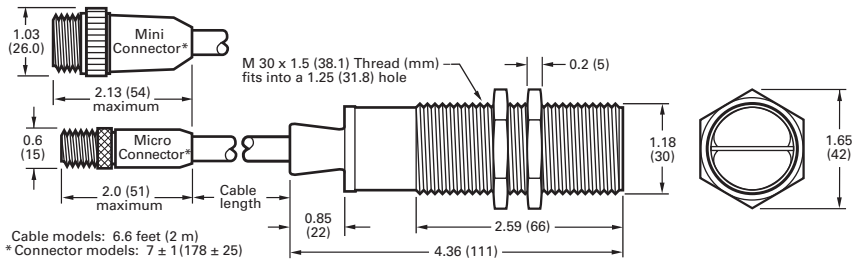

E67 Long Range Perfect Prox Series Sensors



Contents

<i>Description</i>	<i>Page</i>
E67 Long Range Perfect Prox Series Sensors	
Product Selection . . . . .	<b>V8-T5-94</b>
Accessories . . . . .	<b>V8-T5-94</b>
Technical Data and Specifications . . . . .	<b>V8-T5-95</b>
Excess Gain . . . . .	<b>V8-T5-95</b>
Wiring Diagrams . . . . .	<b>V8-T5-96</b>
Dimensions . . . . .	<b>V8-T5-96</b>

E67 Long Range Perfect Prox Series Sensors

Product Description

The E67 Long Range Perfect Prox Series from Eaton’s Electrical Sector, the highest performing long-range sensor you can buy with background rejection, is ideal for your most difficult sensing applications.

The E67 Long Range Perfect Prox Series reliably detects targets in range regardless of variations in color, reflectance, contrast or surface shape while ignoring objects just slightly outside the target range.

The standard E67 sensor is conveniently pre-set with a six-foot range. Ranges of three to eight feet are available pre-set from the factory.

Features

- Perfect Prox technology provides exceptional background rejection and application problem solving
- Extended sensing ranges (up to eight feet) available
- No user adjustments required
- Dual indicators communicate both output and power status from an easy-to-see location at the top of the sensor housing
- Models available with both AC and DC operation in a single unit—up to 132 volts AC and DC
- AC/DC models offer isolated contact output for wiring flexibility
- DC-only sensors offer both NPN and PNP outputs
- Two mounting options for maximum flexibility
- Fully sealed package

**⚠ DANGER**

**THIS SENSOR IS NOT A SAFETY DEVICE AND IS NOT INTENDED TO BE USED AS A SAFETY DEVICE. This sensor is designed only to detect and read certain data in an electronic manner and perform no use apart from that, specifically no safety-related use. This sensor product does not include self-checking redundant circuitry, and the failure of this sensor product could cause either an energized or de-energized output condition, which could result in death, serious bodily injury, or property damage.**

Standards and Certifications

- RoHS Compliant



For the most current information on this product, visit our Web site: [www.eaton.com](http://www.eaton.com)

For Customer Service in the U.S. call 1-877-ETN CARE (386-2273), in Canada call 1-800-268-3578.  
For Application Assistance in the U.S. and Canada call 1-800-426-9184.

#### Product Selection

#### E67 Long Range Perfect Prox Series Sensors

##### E67 Long Range



#### Four-Wire Sensors



Operating Voltage	Sensing Range <sup>①②</sup>	Optimum Range <sup>③</sup>	Cutoff Range <sup>④</sup>	Field of View	Sensing Beam	Connection Type	Light Operate Catalog Number	Dark Operate Catalog Number
18–30 Vdc	79 in (200 cm)	12 to 60 in (30 to 150 cm)	91 in (230 cm)	6 in (15 cm) diameter at 79 in (200 cm)	Infrared beam	4-pin micro DC connector	<b>E67-LRDP200-HLD</b> ☹	<b>E67-LRDP200-HDD</b> ☹
	⑤	⑤	⑤	⑤	Infrared beam	4-pin micro DC connector	<b>E67-LRDPXXX-HLD</b> ☹	<b>E67-LRDPXXX-HDD</b> ☹
20–132 Vac 20–132 Vdc	79 in (200 cm)	12 to 60 in (30 to 150 cm)	91 in (230 cm)	6 in (15 cm) diameter at 79 in (200 cm)	Infrared beam	4-pin, micro AC connector	<b>E67-LRDP200-KLD</b> ☹	<b>E67-LRDP200-KDD</b> ☹
	⑤	⑤	⑤	⑤	Infrared beam	4-pin micro AC connector	<b>E67-LRDPXXX-KLD</b> ☹	<b>E67-LRDPXXX-KDD</b> ☹

#### Compatible Connector Cables

##### Micro-Style, Straight Female



#### Standard Cables—Micro <sup>⑥</sup>

Voltage Style	Number of Pins	Gauge	Length	Pin Configuration/ Wire Colors (Face View Female Shown)	PVC Jacket Catalog Number	PUR Jacket Catalog Number	IRR PUR Jacket Catalog Number
<b>Micro-Style, Straight Female</b>							
AC	4-pin, 4-wire	22 AWG	6 ft (2 m)		<b>CSAS4F4CY2202</b>	<b>CSAS4F4RY2202</b>	<b>CSAS4F4IO2202</b>
DC	4-pin, 4-wire	22 AWG	6 ft (2 m)		<b>CSDS4A4CY2202</b>	<b>CSDS4A4RY2202</b>	<b>CSDS4A4IO2202</b>

#### Accessories

#### E67 Long Range Perfect Prox Series Sensors

Description	Reference
Mounting brackets	See <b>Tab 8, section 8.2</b>
Connector cables	See <b>Tab 10, section 10.1</b>

#### Notes

☹ See listing of compatible connector cables on this page.

① Ranges based on an 18 in white card.

② Also consider the cutoff range when selecting a sensing range. Guaranteed cutoff will be approximately 12 in (30 cm) beyond the sensing range. If a background is present within this zone, adjustments to the application or the sensing range will need to be made.

③ Sensor will detect a 90% reflectance card at this range.

④ Sensor will ignore a 90% reflectance card at this range.

⑤ Custom ranges available:

**Sensor Options (Built-to-order, contact Eaton's Sensor Applications Department at 1-800-426-9184 for delivery lead times).**

The sensing range of this device can be set at the factory to between 60 cm and 240 cm in 10 cm increments. To order, substitute the range (in centimeters) in the model number in place of the standard **200** centimeters. For example, for a device that detects out to 4 ft (4 ft x 12 in/ft x 2.54 centimeters/in), that equates to 121.92 cm. Rounding up (or down, depending on your needs) to the nearest 10 cm yields a sensing range of 130 cm. Therefore, for a light-operate AC/DC device, you would order **E67-LRDP130-KLD**.

⑥ For a full selection of connector cables, see **Tab 10, section 10.1**.

**Technical Data and Specifications**

**E67 Long Range Perfect Prox Series Sensors**

Description	AC/DC Models	DC Only Models
Input voltage	20 to 132 Vac, 50/60 Hz 20 to 132 Vdc	18 to 30 Vdc
Power dissipation	2W maximum	0.5W maximum
Output type	Solid-state relay, 1500 V isolation	NPN and PNP
Voltage switching capacity	400 Vac/dc	30 Vdc
Current switching capacity	75 mA maximum	100 mA maximum
OFF-state leakage	100 µA maximum	50 µA maximum
ON-state characteristics	35 ohms maximum resistance	NPN: 1.5V drop at 100 mA, maximum PNP: 2.5V drop at 100 mA, maximum
Short circuit protection	Thermally current limited at approximately 200 mA ①	Protected against dead shorts only ①②
Response time	50 ms	15 ms
Light/dark operation	Specified by catalog number	Specified by catalog number
Temperature range		
Operating	-31° to 131°F (-35° to 55°C)	-31° to 131°F (-35° to 55°C)
Storage	-40° to 158°F (-40° to 70°C)	-40° to 158°F (-40° to 70°C)

Description	All Models
Material of construction	Enclosure: Lexan® Polycarbonate; back cover: Cyclooy® Polycarbonate/ABS; indicator viewing window: Lexan® Polycarbonate; jam nut and connector: 15% glass-filled nylon 6/6; Threaded inserts: Brass ③
Mounting	Jam-nut: Do not exceed 100 in-lbs mounting torque, minimum panel thickness 0.150 in Side-mounting: Sensor includes 2 sets of #10-32 threaded inserts Tighten to no more than 35 in-lbs Use #10-32 x 0.250 in fasteners with split-type washer for panel thickness between 0.048 in and 0.080 in For other panel thicknesses, choose fastener and washers to ensure minimum thread engagement of 0.120 in and a maximum thread engagement of 0.155 in
Connector models	Micro-connector, 4-pin male
Vibration and shock	Vibrations: 10g over 10 Hz to 2 kHz; shock: 30g for 6 ms 1/2 sine wave pulse
Indicator LED	Red: Lights steady when output is on; green: Lights steady when power is applied to sensor
Sunlight immunity	5000 ft-candles
Enclosure ratings	NEMA 1, 2, 3, 4, 4X, 6, 12 and 13 ④

**Excess Gain**

**Nominal Unit with Fixed 79 in Sensing Range**

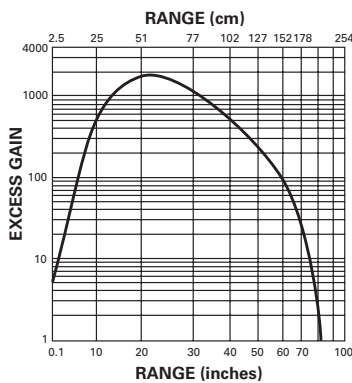

**Notes**

- ① **IMPORTANT:** Output will reset automatically when short is removed (there is no visual indication of a short circuit condition).
- ② **CAUTION:** Will not protect against overloads between 100 mA and 250 mA.
- ③ **IMPORTANT:** Do not expose to concentrated acids, alcohols or ketones.
- ④ These products conform to NEMA tests as indicated, however, some severe washdown applications can exceed these NEMA test specifications.



# 5.9

## Photoelectric Sensors

### E67 Long Range Perfect Prox Series Sensors

#### Wiring Diagrams

Pin numbers are for reference, rely on pin location when wiring.

#### AC/DC Models <sup>①②</sup>

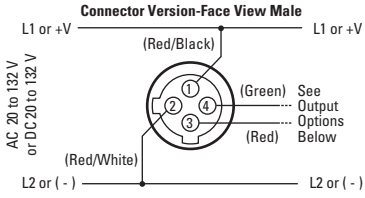

#### Isolated Output Options

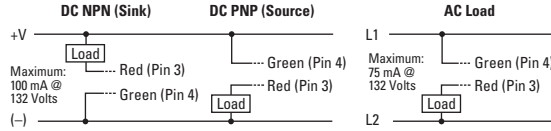

#### DC Only Models <sup>①</sup>

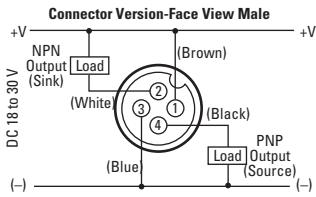

#### Dimensions

Approximate dimensions in inches (mm)

#### E67 Long Range Perfect Prox Series Sensors

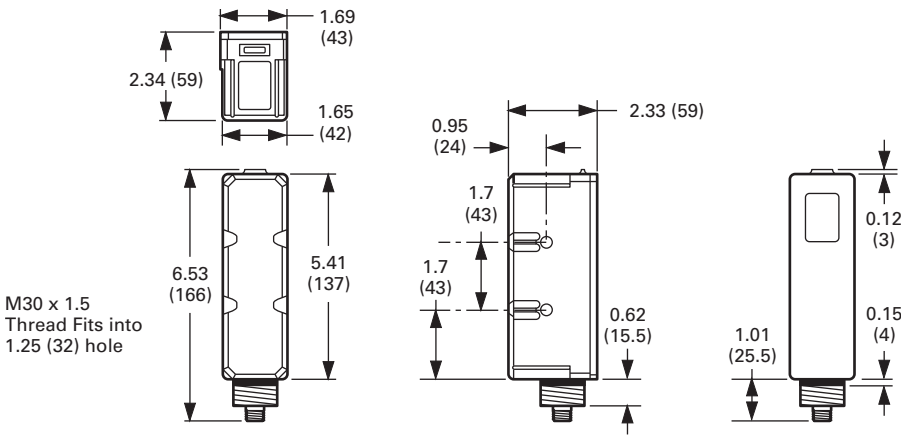

#### Notes

- ① Connector versions: The pin numbering and wire colors are typical of several manufacturers, however, variations are possible. In case of discrepancies, rely on function indicated and pin location rather than pin number or wire color.
- ② Sensor operates on DC voltage, but isolated output can switch AC or DC loads.

E51 Limit Switch Style, Modular Sensors



Contents

<i>Description</i>	<i>Page</i>
E51 Limit Switch Style, Modular Sensors	
Product Selection	
Assembled Sensors . . . . .	V8-T5-98
Sensor Heads . . . . .	V8-T5-100
Sensor Bodies . . . . .	V8-T5-101
Logic Module . . . . .	V8-T5-102
Receptacles . . . . .	V8-T5-102
Compatible Connector Cables . . . . .	V8-T5-103
Accessories . . . . .	V8-T5-72
Technical Data and Specifications . . . . .	V8-T5-104
Excess Gain . . . . .	V8-T5-104
Wiring Diagrams . . . . .	V8-T5-105
Dimensions . . . . .	V8-T5-106

E51 Limit Switch Style, Modular Sensors

Product Description

E51 Limit Switch Style Modular Sensors from Eaton’s Electrical Sector are available in thru-beam, reflex, polarized reflex, diffuse reflective and fiber optic sensing modes to solve a wide variety of sensing applications. Modular, plug-in components are easy to maintain, meaning less downtime and reduced inventory. Choose between two-wire sensors with AC/DC operation and four-wire sensors in either AC or DC styles. Connection options include terminal, mini-connector and various lengths of cable. Sensors can be ordered in component form or as fully assembled units.

Features

- Choose from five different sensing modes including fiber optic
- All heads feature a selector switch for light or dark operation
- Logic modules are available to provide additional control functions
- Rugged construction, ideal for industrial environments
- Viton gaskets ensure a positive seal and high chemical resistance
- Sensor heads can be rotated to any of four positions
- Components are interchangeable with E51 proximity sensors
- Sensors accommodate both U.S. and DIN mounting dimensions
- Sensor bodies feature bifurcated engagement prongs for a reliable electrical connection when plugging into receptacle stabs

Standards and Certifications

- UL Listed, E166051, E183975
- CSA Certified, 50513



**⚠ DANGER**

**THIS SENSOR IS NOT A SAFETY DEVICE AND IS NOT INTENDED TO BE USED AS A SAFETY DEVICE. This sensor is designed only to detect and read certain data in an electronic manner and perform no use apart from that, specifically no safety-related use. This sensor product does not include self-checking redundant circuitry, and the failure of this sensor product could cause either an energized or de-energized output condition, which could result in death, serious bodily injury, or property damage.**

For the most current information on this product, visit our Web site: [www.eaton.com](http://www.eaton.com)

For Customer Service in the U.S. call 1-877-ETN CARE (386-2273), in Canada call 1-800-268-3578.  
For Application Assistance in the U.S. and Canada call 1-800-426-9184.

#### Product Selection

#### Assembled Sensors

##### Assembled Sensor



##### Sensor Heads ④

##### Reflex



##### Polarized Reflex



##### Diffuse Reflective



##### Thru-Beam Detector



##### Thru-Beam Source



#### Reflex, Diffuse Reflective and Thru-Beam Sensors

##### Sensor Body and Receptacle



Operating voltage  
Output  
Sensor body

**Two-Wire Sensors**  
20–264 Vac/dc  
NO or NC ①  
**E51SAL**

**Four-Wire Sensors**  
120 Vac  
NO and NC complementary  
**E51SCL**  
**E51SCN**  
Accepts logic module ②

10–30 Vdc  
NO and NC complementary  
**E51SNL**  
NPN  
**E51SPL**  
PNP

Receptacle ③

**E51RA**

**E51RC**

**E51RCB**

**E51RN**

**E51RN**

**Sensing Range**

**Response Time**

**Sensing Beam**

**Sensor Head Only Catalog Number**

**Assembled Sensors with Head, Sensor Body and Receptacle Catalog Number**

##### Reflex

18 ft (5.5 m)	Standard response	Infrared	<b>E51DP1</b>	<b>E51ALP1</b>	<b>E51CLP1</b>	<b>E51CNP1</b>	<b>E51NLP1</b>	<b>E51PLP1</b>
35 ft (10.7 m)	Standard response		<b>E51DP3</b>	—	<b>E51CLP3</b>	<b>E51CNP3</b>	<b>E51NLP3</b>	<b>E51PLP3</b>

##### Polarized Reflex

15 ft (4.5 m)	Standard response	Visible red	<b>E51DP5</b>	—	<b>E51CLP5</b>	<b>E51CNP5</b>	<b>E51NLP5</b>	<b>E51PLP5</b>
---------------	-------------------	-------------	---------------	---	----------------	----------------	----------------	----------------

##### Diffuse Reflective

8 in (200 mm)	Standard response	Infrared	<b>E51DP2</b>	<b>E51ALP2</b>	<b>E51CLP2</b>	<b>E51CNP2</b>	<b>E51NLP2</b>	<b>E51PLP2</b>
	Fast response		<b>E51DP22</b>	—	<b>E51CLP22</b>	<b>E51CNP22</b>	<b>E51NLP22</b>	<b>E51PLP22</b>
18 in (450 mm)	Standard response		<b>E51DP6</b>	—	<b>E51CLP6</b>	<b>E51CNP6</b>	<b>E51NLP6</b>	<b>E51PLP6</b>
40 in (1 m)	Standard response		<b>E51DP4</b>	—	<b>E51CLP4</b>	<b>E51CNP4</b>	<b>E51NLP4</b>	<b>E51PLP4</b>

##### Thru-Beam Detector

300 ft (90 m)	Standard response	—	<b>E51DC1</b>	<b>E51ALC1</b>	<b>E51CLC1</b>	<b>E51CNC1</b>	<b>E51NLC1</b>	<b>E51PLC1</b>
---------------	-------------------	---	---------------	----------------	----------------	----------------	----------------	----------------

##### Thru-Beam Source ⑤

300 ft (90 m)	—	Infrared with visible red alignment aid	<b>E51DEL</b>	<b>E51ELA</b> ⑤	<b>E51ELA</b> ⑤	<b>E51ELA</b> ⑤	<b>E51ELA</b> ⑤	<b>E51ELA</b> ⑤
			<b>E51DED</b>	<b>E51EDN</b> ⑥	<b>E51EDN</b> ⑥	<b>E51EDN</b> ⑥	<b>E51EDN</b> ⑥	<b>E51EDN</b> ⑥

#### Notes

⊕⊖ See listing of compatible connector cables on [Page V8-T5-103](#).

① All sensor heads feature a light or dark operation selector switch which reverses the output function.

② Logic module must be ordered separately, see [Page V8-T5-102](#). These sensor bodies are rated NEMA 4, 4X and 13.

③ Receptacles feature terminal wiring with a 1/2 in NPT thread at the conduit entrance. Other connection options are available (see below and [Page V8-T5-103](#)).

Connection Option		Suffix	Example
20 mm thread at the conduit entrance		<b>20</b>	<b>E51ALP120</b>
Built-in mini-connector with epoxy filled receptacle	2-wire, 3-pin connector	<b>P3</b>	<b>E51ALP1P3</b> ⊕
	4-wire, 5-pin connector	<b>P5</b>	<b>E51CLP1P5</b> ⊕
Pigtail with mini-connector	2-wire, AC/DC	<b>T3</b>	<b>E51RAPT3</b> ⊕
	4-wire, AC	<b>T5</b>	<b>E51RCT5</b> ⊕
	4-wire, DC	<b>T5</b>	<b>E51RNPT5</b> ⊕
Pre-wired cable with epoxy filled receptacle	8 ft long	<b>S</b>	<b>E51ALP1S</b>
	12 ft long	<b>S12</b>	<b>E51ALP1S12</b>
	20 ft long	<b>S20</b>	<b>E51ALP1S20</b>

④ Includes sensor head mounted to sensor body. Head can be rotated to any of four discrete positions on body, 90° apart, but is not separate from body.

⑤ 120 Vac operation.

⑥ 10–30 Vdc operation.

Assembled Sensor



Sensor Heads ①

Glass Fiber Optic, Standard Fiber Mounting Style



Glass Fiber Optic, Collar Fiber Mounting Style



Glass Fiber Optic Sensors

Sensor Body and Receptacle



Operating voltage  
Output  
Sensor body

Two-Wire Sensors

20–264 Vac/dc  
NO or NC ①

Four-Wire Sensors

120 Vac  
10–30 Vdc  
NO and NC complementary  
NO and NC complementary

**E51SAL**

**E51SCL**

**E51SCN**  
Accepts logic module ②

**E51SNL**

NPN

**E51SPL**

PNP

Receptacle ③

**E51RA**

**E51RC**

**E51RCB**

**E51RN**

**E51RN**

Sensing Range

Response Time

Sensor Head Only Catalog Number

Assembled Sensors with Head, Sensor Body and Receptacle Catalog Number

Glass Fiber Optic, Standard Fiber Mounting Style ④

3 in (75 mm) ⑤ 25 in (650 mm) ⑥	Standard response	<b>E51DF1</b>	—	<b>E51CLF1</b>	<b>E51CNF1</b>	<b>E51NLF1</b>	<b>E51PLF1</b>
1 in (25 mm) ⑤ 9 in (225 mm) ⑥	Fast response	<b>E51DF11</b>	—	<b>E51CLF11</b>	<b>E51CNF11</b>	<b>E51NLF11</b>	<b>E51PLF11</b>

Glass Fiber Optic, Collar Fiber Mounting Style ④

3 in (75 mm) ⑤ 25 in (650 mm) ⑥	Standard response	<b>E51DF3</b>	—	<b>E51CLF3</b>	<b>E51CNF3</b>	<b>E51NLF3</b>	<b>E51PLF3</b>
1 in (25 mm) ⑤ 9 in (225 mm) ⑥	Fast response	<b>E51DF33</b>	—	<b>E51CLF33</b>	<b>E51CNF33</b>	<b>E51NLF33</b>	<b>E51PLF33</b>

Notes

- ④ ⑤ See listing of compatible connector cables on **Page V8-T5-103**.
- ① All sensor heads feature a light or dark operation selector switch which reverses the output function.
- ② Logic module must be ordered separately, see **Page V8-T5-102**. These sensor bodies are rated NEMA 4, 4X and 13.
- ③ Receptacles feature terminal wiring with a 1/2 in NPT thread at the conduit entrance. Other connection options are available (see below and **Page V8-T5-103**).

Connection Option		Suffix	Example
20 mm thread at the conduit entrance		<b>20</b>	<b>E51ALP120</b>
Built-in mini-connector with epoxy filled receptacle	2-wire, 3-pin connector	<b>P3</b>	<b>E51ALP1P3</b> ④
	4-wire, 5-pin connector	<b>P5</b>	<b>E51CLP1P5</b> ④
Pigtail with mini-connector	2-wire, AC/DC	<b>T3</b>	<b>E51RAPT3</b> ④
	4-wire, AC	<b>T5</b>	<b>E51RCPT5</b> ④
	4-wire, DC	<b>T5</b>	<b>E51RNPT5</b> ④
Pre-wired cable with epoxy filled receptacle	8 ft long	<b>S</b>	<b>E51ALP1S</b>
	12 ft long	<b>S12</b>	<b>E51ALP1S12</b>
	20 ft long	<b>S20</b>	<b>E51ALP1S20</b>

- ④ Requires glass fiber optic cables for operation (not included), see **Tab 9, section 9.2**.
- ⑤ Sensing range for diffuse reflective mode for 0.125 in (3.2 mm) diameter fibers. See **Page V8-T5-104** for complete sensing range specifications.
- ⑥ Sensing range in thru-beam mode for 0.125 in (3.2 mm) diameter fibers. See **Page V8-T5-104** for complete sensing range specifications.

# 5.10

## Photoelectric Sensors

### E51 Limit Switch Style, Modular Sensors

#### Sensor Heads

#### Reflex, Diffuse Reflective and Thru-Beam Sensors<sup>①</sup>

Sensing Range <sup>②</sup>	Field of View	Response Time				Sensing Beam	Adjustment	Input Voltage	Catalog Number
		ON AC Sensor	DC Sensor	OFF AC Sensor	DC Sensor				
<b>Reflex</b>									
18 ft (5.5 m)	6 in (152 mm) diameter at 15 ft (4.6 m)	20 ms	20 ms	30 ms	22 ms	Infrared	—	—	<b>E51DP1</b>
35 ft (10.7 m)	12 in (305 mm) diameter at 35 ft (10.7 m)	20 ms	20 ms	30 ms	22 ms	Infrared	—	—	<b>E51DP3</b>
<b>Polarized Reflex</b>									
15 ft (4.5 m)	6 in (152 mm) diameter at 15 ft (4.6 m)	20 ms	20 ms	30 ms	22 ms	Visible red	—	—	<b>E51DP5</b>
<b>Diffuse Reflective</b>									
8 in (200 mm)	1 in (25 mm) diameter at 4 in (101 mm)	20 ms	20 ms	30 ms	22 ms	Infrared	Near/far <sup>③</sup>	—	<b>E51DP2</b>
		1 ms	0.5 ms	9 ms	0.5 ms	Infrared	Near/far <sup>③</sup>	—	<b>E51DP22</b>
18 in (450 mm)	1 in (25 mm) diameter at 9 in (228 mm)	20 ms	20 ms	30 ms	22 ms	Infrared	Near/far <sup>③</sup>	—	<b>E51DP6</b>
40 in (1 m)	1.5 in (38 mm) diameter at 40 in (1 m)	20 ms	20 ms	30 ms	22 ms	Infrared	—	—	<b>E51DP4</b>
<b>Thru-Beam Detector</b>									
300 ft (90 m)	18 in (457 mm) diameter at 20 ft (6.1 m)	10 ms	5 ms	10 ms	5 ms	—	Sensitivity	—	<b>E51DC1</b>
<b>Thru-Beam Source<sup>④</sup></b>									
300 ft (90 m)	36 in (914 mm) diameter at 20 ft (6.1 m)	—	—	—	—	Infrared with visible red alignment aid	—	120 Vac	<b>E51DEL</b>
		—	—	—	—		10–30 Vdc	<b>E51DED</b>	

#### Notes

- ① All sensor heads feature a light or dark operation selector switch.
- ② Reflex ranges are based on a 3 in retroreflector; diffuse reflective ranges are based on a 90% reflectance white card.
- ③ These sensor heads have a mechanical Near/Far adjustment which adjust the head for optimum performance at the expected target distance. The adjustment, which move the optics and adjustment indicator, is made before the head is mounted on the sensor body. Excess gain graphs are shown in the "Far" setting.
- ④ Includes sensor head mounted to sensor body. Use receptacles E51RA for AC or E51RN for DC sources. Head can be rotated to any of four discrete positions on body, 90° apart, but is not separate from the body.

**Glass Fiber Optic Sensors** ①

**Sensing Range** ②

Thru-Beam Mode		Diffuse Reflective Mode		Response Time		OFF		Sensing Beam	Adjustment	Catalog Number
0.063 In Dia. Fibers	0.125 In Dia. Fibers	0.063 In Dia. Fibers	0.125 In Dia. Fibers	ON AC Sensor	DC Sensor	AC Sensor	DC Sensor			
<b>Standard Fiber Mounting Style</b> ③										
8 in (200 mm)	25 in (650 mm)	0.6 in (15 mm)	3 in (75 mm)	20 ms	20 ms	30 ms	22 ms	Infrared	—	<b>E51DF1</b>
3 in (75 mm)	9 in (225 mm)	0.25 in (6 mm)	1 in (25 mm)	0.5 ms	0.5 ms	9 ms	0.5 ms	Infrared	—	<b>E51DF11</b>
<b>Collar Fiber Mounting Style</b> ③										
8 in (200 mm)	25 in (650 mm)	0.6 in (15 mm)	3 in (75 mm)	20 ms	20 ms	30 ms	22 ms	Infrared	Sensitivity	<b>E51DF3</b>
3 in (75 mm)	9 in (225 mm)	0.25 in (6 mm)	1 in (25 mm)	0.5 ms	0.5 ms	9 ms	0.5 ms	Infrared	Sensitivity	<b>E51DF33</b>
10 in (250 mm)	40 in (1000 mm)	0.8 in (20 mm)	4.5 in (115 mm)	20 ms	20 ms	30 ms	22 ms	Infrared	—	<b>E51DF4</b>

**Standard Fiber Mounting Style**



**Collar Fiber Mounting Style**



**Sensor Bodies**

**AC/DC**



**Two-Wire Sensors**

Operating Voltage	Output	Protection	Output Rating Continuous	Type	Catalog Number
<b>AC/DC</b>					
20–264 Vac/dc, 50/60 Hz	One output, load powered, NO or NC, programmable from head; OFF-state leakage current: 1.7 mA at 120 Vac/dc, <2.0 mA at 240 Vac	Latching short circuit and overload	0.5A	—	<b>E51SAL</b> ④

**Four-Wire Sensors**

**AC (E51SCN Shown)**



Operating Voltage	Output	Protection	Output Rating Continuous	Type	Catalog Number
<b>AC</b>					
120 Vac, 50/60 Hz	Two complementary outputs, line powered, NO and NC	—	1.0A to 158°F (70°C), linearly derated to 0.6A at 176°F (80°C)	—	<b>E51SCL</b> ④
			1.0A to 113°F (45°C), linearly derated to 0.3A at 176°F (80°C)	Accepts logic modules (see <b>Page V8-T5-102</b> )	<b>E51SCN</b> ⑤

**DC**



Operating Voltage	Output	Protection	Output Rating Continuous	Type	Catalog Number
<b>DC</b>					
10–30 Vdc	Two complementary outputs, line powered, NO and NC Burden current: <25 mA OFF-state leakage: <100 µA ON-state: <2.5 Vdc Power-up delay: <150 ms	Reverse polarity	0.6A to 104°F (40°C), linearly derated to 0.36A at 176°F (80°C)	NPN	<b>E51SNL</b> ④ ☐ ☐
				PNP	<b>E51SPL</b> ④ ☐ ☐

**Notes**

- ① All sensor heads feature a light or dark operation selector switch.
- ② Diffuse reflective ranges are based on a 90% reflectance white card.
- ③ Requires glass fiber optic cables for operation (not included), see **Tab 9, section 9.2**.
- ④ This sensor body is available in a factory-sealed, non plug-in configuration (with 8 ft cable), add **6P** to listed catalog number. Example: E51SAL**6P**.
- ⑤ Sensor body is black. E51SCN sensor bodies are rated NEMA 4, 4X and 13.

#### Logic Module

##### Logic Module ①



##### Logic Module (for E51SCN Sensor Body Only)

Type	Reset Time	Description	Timing Range ②	Catalog Number
ON and OFF delay	25 ms minimum	Adjustable delay between time object is sensed and time switch function occurs  Adjustable delay between time object leaves sensing field and time switch transfers back to non-sensing state	0.15 to 15.0 seconds	<b>E51MTB</b>

#### Receptacles

##### Receptacles for E51 Limit Switch

Description	Style	Details	Cable Length	Conduit Entrance	
				1/2 In NPT Catalog Number	20 mm Catalog Number
<b>Surface Mount</b>					
<b>Surface Mount</b>					
Conduit entrance, front or rear mounting	2-wire, AC/DC	—	—	<b>E51RA</b>	<b>E51RA20</b>
	4-wire, AC	Gray	—	<b>E51RC</b>	<b>E51RC20</b>
		Black ③	—	<b>E51RCB</b>	<b>E51RCB20</b>
	4-wire, DC	—	—	<b>E51RN</b>	<b>E51RN20</b>
<b>Built-In Mini-Connector</b>					
<b>Built-In Mini-Connector</b>					
Epoxy filled receptacle with pre-wired mini-connector	2-wire, AC/DC	3-pin	—	<b>E51RAP3</b> ☺	—
	4-wire, AC	5-pin	—	<b>E51RCP5</b> ☺	—
		5-pin	—	<b>E51RNP5</b> ☺	—
<b>Pigtail with Mini-Connector</b>					
<b>Pigtail with Mini-Connector</b>					
Epoxy filled receptacle with mini-connector mounted on 3 ft (900 mm) cable	2-wire, AC/DC	3-pin	3 ft (0.9 m)	<b>E51RAPT3</b> ☺	—
	4-wire, AC	5-pin	3 ft (0.9 m)	<b>E51RCPT5</b> ☺	—
		5-pin	3 ft (0.9 m)	<b>E51RNPT5</b> ☺	—
<b>Prewired Cable</b>					
<b>Prewired Cable</b>					
Epoxy filled receptacle with pre-wired 16 gauge, yellow jacketed, type SOOW-A cable. Cable enters through hole threaded for conduit	2-wire, AC/DC	3-conductor	8 ft (2.4 m)	<b>E51RAS</b>	<b>E51RA20S</b>
			12 ft (3.6 m)	<b>E51RAS12</b>	—
			20 ft (6 m)	<b>E51RAS20</b>	—
	4-wire, AC	5-conductor	8 ft (2.4 m)	<b>E51RCS</b>	<b>E51RC20S</b>
			12 ft (3.6 m)	<b>E51RCS12</b>	—
			20 ft (6 m)	<b>E51RCS20</b>	—
	4-wire, DC	5-conductor	8 ft (2.4 m)	<b>E51RNS</b>	<b>E51RN20S</b>
			12 ft (3.6 m)	<b>E51RNS12</b>	—
			20 ft (6 m)	<b>E51RNS20</b>	—

#### Notes

☺☺ See listing of compatible connector cables on [Page V8-T5-103](#).

① Rated NEMA 4, 4X and 13.

② Repeatability of the timing cycle is ±1% at constant voltage, ambient temperature and reset time.

③ Black receptacle is for color compatibility with E51SCN sensor body.

**Compatible Connector Cables**

**Mini Style  
Straight Female**



**E51 Limit Switch Style, Modular Sensors** <sup>①</sup>

Current Rating at 600V	Voltage Style	Number of Pins	Gauge	Length	Pin Configuration/Wire Colors (Face View Female Shown)	Catalog Number
<b>Standard Cables—Mini Style</b>						
13A	AC/DC	3-pin	16 AWG	6 ft (2 m)		CSMS3F3CY1602
8A	AC/DC	5-pin	16 AWG	6 ft (2 m)		CSMS5D5CY1602

**Accessories**

**E51 Limit Switch Style, Modular Sensors**

Description	Catalog Number
<p><b>One-hole, Universal</b></p> <p><b>Universal Mounting Bracket</b> One-hole, includes mounting hardware, stainless steel</p>	<b>E51KH2</b>
<p><b>Two-hole, Universal</b></p> <p><b>Universal Mounting Bracket</b> Two-hole, includes mounting hardware, steel</p>	<b>E51KH4</b>
<p><b>Machine Mounting Bracket</b></p> <p><b>Machine Mounting Bracket</b> Zinc die cast</p>	<b>E50KH3</b>
<p><b>Stand-Off Mounting Bracket</b></p> <p><b>Stand-Off Mounting Bracket</b> Steel</p>	<b>E51KH3</b>
<p><b>Remote Sensor Head Assembly</b></p> <p><b>Remote Sensor Head Assembly</b> Permits mounting sensor head up to 3 ft (0.9 m) from sensor body</p>	<b>E51KRM</b>

**Connector Cables**

A variety of cables, connector blocks and accessories, see **Tab 10, section 10.1**

**Dimensions**, see **Page V8-T5-106**.

**Note**

<sup>①</sup> For a full selection of connector cables, see **Tab 10, section 10.1**.



#### Technical Data and Specifications

##### E51 Limit Switch Style, Modular Sensors

Description	Specification
Output ratings (NEMA D150)	
AC/DC models	0.5A continuous
AC models	1A continuous
DC models	0.6A continuous
Protection	Latching short circuit protection on two-wire AC/DC and four-wire DC models
Indicator LEDs	Lights when output is ON. One LED for each output
Enclosure material	Zinc die cast
Gasket material	Viton
Enclosure ratings	NEMA 3, 3S, 4, 4X, 6, 6P, 12 and 13 (IP67) E51SCN sensor body only: NEMA 4, 4X and 13 ①
Hazardous locations ratings	
Class I	Division II—GRPS ABCD
Class II	Division II—GRPS F and G
Class III	Division 2
Temperature range	-13° to 158°F (-25° to 70°C)
Torque requirements	Switch body screws: 25–30 in-lb; Sensing head screws: 14–18 in-lb
Vibration	10–55 Hz, 1 mm amplitude
Shock	30g, 11 ms, 1/2 sine wave
Humidity	95% non-condensing

#### Excess Gain

##### Sensor Heads—Reflex, Diffuse Reflective and Thru-Beam

###### Reflex (3 in diameter retroreflector)

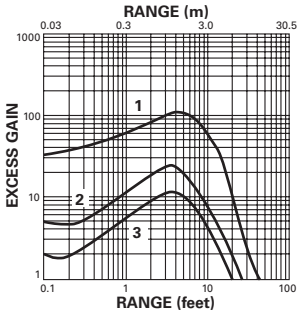

- 1. E51DP3
- 2. E51DP1
- 3. E51DP5

###### Diffuse Reflective (90% reflective white card)

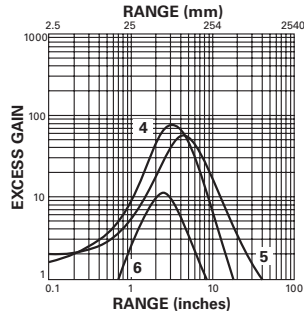

- 4. E51DP6
- 5. E51DP4
- 6. E51DP2 and E51DP22

###### Thru-Beam

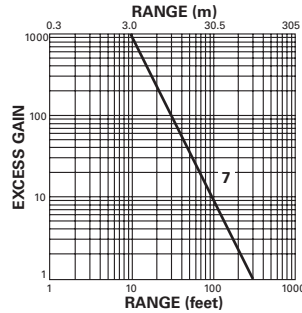

- 7. E51DEL and E51DED sources using E51DC1 detector

#### Note

① Our products conform to NEMA tests as indicated, however, some severe washdown applications can exceed these NEMA test specifications.

**Sensor Heads—Glass Fiber Optic**

**Diffuse Reflective (90% reflective white card)**

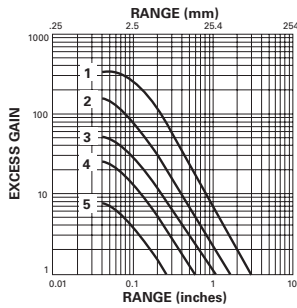

**E51DF1 and E51DF3 high power sensor head with:**

- 1. 0.125 in fiber bundle
- 2. 0.094 in fiber bundle
- 4. 0.063 in fiber bundle

**E51DF33 fast response sensor head with:**

- 3. 0.125 in fiber bundle
- 4. 0.094 in fiber bundle
- 5. 0.063 in fiber bundle

**Thru-Beam**

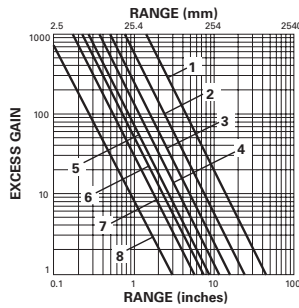

**E51DF4 extended range sensor head with:**

- 1. 0.125 in fiber bundle
- 4. 0.063 in fiber bundle

**E51DF1 and E51DF3 high power sensor head with:**

- 2. 0.125 in fiber bundle
- 3. 0.094 in fiber bundle
- 6. 0.063 in fiber bundle

**E51DF33 fast response sensor head with:**

- 5. 0.125 in fiber bundle
- 7. 0.094 in fiber bundle
- 8. 0.063 in fiber bundle

**Wiring Diagrams**

Pin numbers are for reference, rely on pin location when wiring.

**E51 Limit Switch Style, Modular Sensors**

Operating Voltage	Output ①	Terminal and Cable Models	Mini-Connector Models (Face View Male Shown)
<b>Two-Wire Sensors</b>			
20–264 Vac or Vdc 50/60 Hz	NO or NC		
<b>Four-Wire Sensors</b>			
120 Vac 50/60 Hz	NO and NC		
10–30 Vdc	NO and NC NPN		
	NO and NC PNP		

**Note**

① Changing light/dark switch on sensor head will reverse output function (NO becomes NC, and NC becomes NO).

# 5.10

## Photoelectric Sensors

### E51 Limit Switch Style, Modular Sensors

#### Dimensions

Approximate Dimensions in mm [in]

#### Standard Sensor

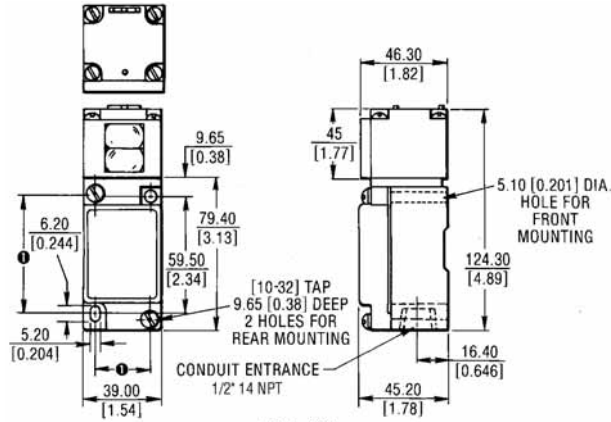

① CAN ACCOMMODATE BOTH U.S. 29.4 x 59.5 [1.16 x 2.34] AND DIN 30 x 60 [1.18 x 2.36] MOUNTING DIMENSIONS.

#### Sensor with Logic Module

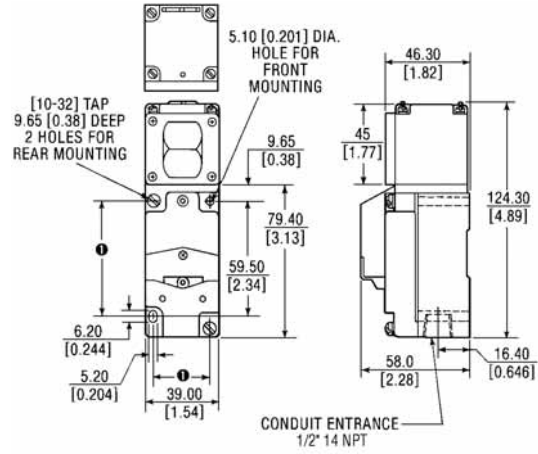

#### Accessories

Approximate dimensions in inches [mm]

#### Universal Mounting Bracket—E51KH2

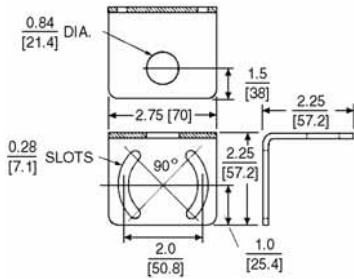

#### Universal Mounting Bracket—E51KH4

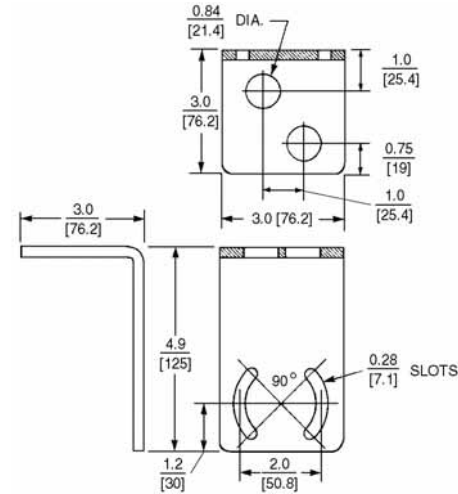

Approximate Dimensions in mm [in]

**Machine Mounting Bracket**

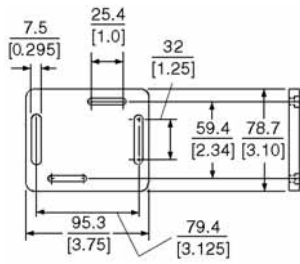

**Stand-Off Mounting Bracket**

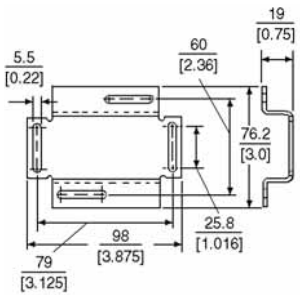

Approximate dimensions in inches [mm]

**Remote Sensor Head Assembly**

