

## DIO61845

# 40V, 0.6A, 2MHz, Synchronous, Step-Down Converter for Power Meters

## Features

- Operating Input Range: 5V to 40V
- Adjustable Output Range: 0.8V to  $0.95 \cdot V_{IN}$
- Operating Quiescent Current: 150 $\mu$ A
- Fixed Switching Frequency: 2MHz
- 400m $\Omega$ /200m $\Omega$  Internal Power MOSFETs
- Optimized for Power Meter Applications
- Satisfies 0.1% Output Voltage Ripple Requirements in Power Meter Applications
- Low Dropout Mode
- Light-Load Mode
- >90% Efficiency
- Dedicated Internal Compensation
- Stable with Ceramic/Electrolytic Output Capacitors
- Internal Soft Start (SS)
- Precision Current Limit without Current Sensing Resistor
- Guaranteed Industrial Temperature Range Limits
- Package: SOT23-6

## Applications

- Power Meters Only

## Descriptions

The DIO61845 is a high-frequency, step-down, switching regulator with integrated high-side and low-side power MOSFET designed specifically for power meter applications. The DIO61845 can provide up to 0.6A output current and current mode control for fast loop response.

The wide input range of 5V to 40V is suitable for various power meter step-down applications. Quiescent current of 10 $\mu$ A shutdown mode allows devices to be used for battery power supply applications. The DIO61845 uses high duty cycle and low dropout mode under the condition of low input voltage of power meter.

The DIO61845 achieves high power conversion efficiency in a wide load range by reducing switching frequency under light load conditions to reduce switching and gate drive losses.

Frequency folding prevents short circuit and inductance current from losing control during startup. Thermal shutdown provides reliable and fault-tolerant operation. The DIO61845 is packaged in SOT23-6.

## Typical Application

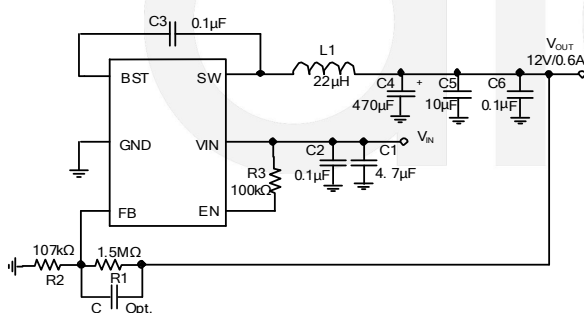

Power Meter 12V Output Rail, 0.6A Load

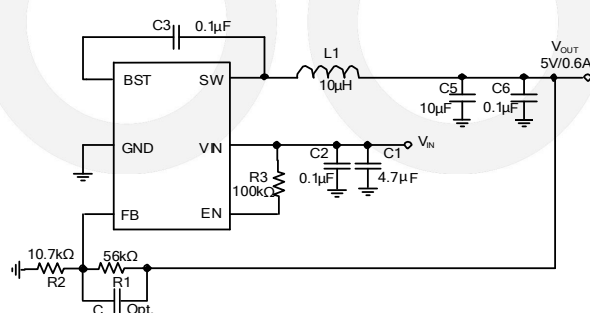

Power Meter 5V Output Rail, 0.6A Load

## Ordering Information

Order Part Number	Top Marking		T <sub>A</sub>	Package	
DIO61845ST6	DAYW	Green	-40 to 85°C	SOT23-6	Tape & Reel, 3000

## Pin Assignment

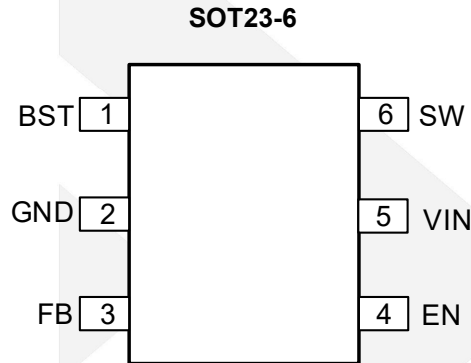

**Figure 1 Top View**

## Pin Descriptions

Pin Name	Description
BST	Bootstrap. Positive power supply for the internal, floating, high-side MOSFET driver. Connect a bypass capacitor between BST and SW.
GND	Ground. Connect an output capacitor as close to GND as possible. Avoid routing GND near high-current switch paths.
FB	Feedback. FB is the input to the error amplifier. Connect FB to an external resistor divider between the output and GND. Compare FB against the internal 0.8V reference to set the regulation voltage.
EN	Enable input. Pull EN below the specified threshold to shut the chip down. Pull EN above the specified threshold to enable the chip. Float EN to disable the chip.
VIN	Input supply. VIN supplies power to the internal control circuitry, both BST regulators, and the high-side switch. Place a decoupling capacitor to ground close to VIN to reduce switching spikes.
SW	Switch node. SW is the output of the high-side switch.

## Absolute Maximum Ratings

Stresses beyond those listed under “Absolute Maximum Rating” may cause permanent damage to the device. These are stress ratings only and functional operation of the device at these or any other condition beyond those indicated in the operational sections of the specifications is not implied. Exposure to absolute maximum rating conditions for extended periods may affect device reliability.

Parameter		Rating	Unit
Supply voltage	$V_{IN}$	-0.3 to 42	V
Switch voltage	$V_{SW}$	-0.3 to ( $V_{IN} + 0.3$ )	V
BST to SW		-0.3 to 6.0	V
All other pins		-0.3 to 6.0	V
Continuous power dissipation ( $T_A = 25^\circ\text{C}$ ) <sup>(1)</sup>		0.6	W
Junction temperature		150	$^\circ\text{C}$
Lead temperature		260	$^\circ\text{C}$
Storage temperature		-65 to 150	$^\circ\text{C}$
Package Thermal Resistance	$\theta_{JA}$	170	$^\circ\text{C}/\text{W}$
	$\theta_{JC}$	130	
ESD	Human Body Mode	1500	V
Latch up		300	mA

Note:

1. The maximum allowable power dissipation is a function of the maximum junction temperature  $T_J(\text{MAX})$ , the junction-to-ambient thermal resistance  $\theta_{JA}$ , and the ambient temperature  $T_A$ . The maximum allowable continuous power dissipation at any ambient temperature is calculated by  $P_D(\text{MAX}) = (T_J(\text{MAX}) - T_A) / \theta_{JA}$ . Exceeding the maximum allowable power dissipation produces an excessive die temperature, and the regulator goes into thermal shutdown. Internal thermal shutdown circuitry protects the device from permanent damage.

## Recommend Operating Conditions

The Recommended Operating Conditions table defines the conditions for actual device operation. Recommended Operating conditions are specified to ensure optimal performance to the datasheet specifications. DIOO does not Recommend exceeding them or designing to Absolute Maximum Ratings.

Parameter		Rating	Unit
Supply voltage	$V_{IN}$	5 to 40	V
Output voltage	$V_{OUT}$	Adjustable from 0.8	V
Operating junction temperature	$T_J$	-40 to 125	$^\circ\text{C}$

## Electrical Characteristics

$V_{IN} = 24V$ ,  $V_{EN} = 2V$ ,  $T_J = -40^{\circ}C$  to  $125^{\circ}C$  <sup>(2)</sup>, unless otherwise noted. Typical values at  $T_J = 25^{\circ}C$ .

Symbol	Parameter	Conditions	Min.	Typ.	Max.	Unit
$V_{FB}$	Feedback voltage	$T_J = -40^{\circ}C$ to $125^{\circ}C$	0.78	0.8	0.82	V
		$T_J = 25^{\circ}C$	0.788	0.8	0.812	
	Feedback bias current				0.1	$\mu A$
$R_{ON\_HS}$	High-side switch on resistance	$V_{BST} - V_{SW} = 5V$		400	800	m $\Omega$
$R_{ON\_LS}$	Low-side switch on resistance			200	400	m $\Omega$
	High-side switch leakage	$V_{EN} = 0V$ , $V_{SW} = 0V$			1	$\mu A$
	Low-side switch leakage				1	$\mu A$
$I_{LIM}$	Current limit		0.8	1.0	1.2	A
	$V_{IN}$ UVLO rising threshold		4.35	4.6	4.85	V
	$V_{IN}$ UVLO falling threshold		3.65	3.9	4.15	V
	$V_{IN}$ UVLO hysteresis			0.7		V
	Soft-start time	$V_{FB}$ from 10% to 90%		0.5	1	ms
$f_{SW}$	Oscillator frequency		1.6	2	2.4	MHz
$t_{ON}$	Minimum switch on time <sup>(3)</sup>			100		ns
$I_S$	Shutdown supply current	$V_{EN} < 0.3V$		10	15	$\mu A$
$I_Q$	Quiescent supply current	No load, $V_{FB} = 0.83V$ , no switching		150	350	$\mu A$
	Thermal shutdown <sup>(3)</sup>			175		$^{\circ}C$
	Thermal shutdown hysteresis <sup>(3)</sup>			30		$^{\circ}C$
$V_{IH}$	Enable rising threshold	Low to high	1.62	1.8	1.98	V
	Enable falling threshold		1.395	1.55	1.705	V
	Enable threshold hysteresis			250		mV

Note:

- Not tested in production and guaranteed by over-temperature correlation.
- Not tested in production and derived from bench characterization.

## Block Diagram

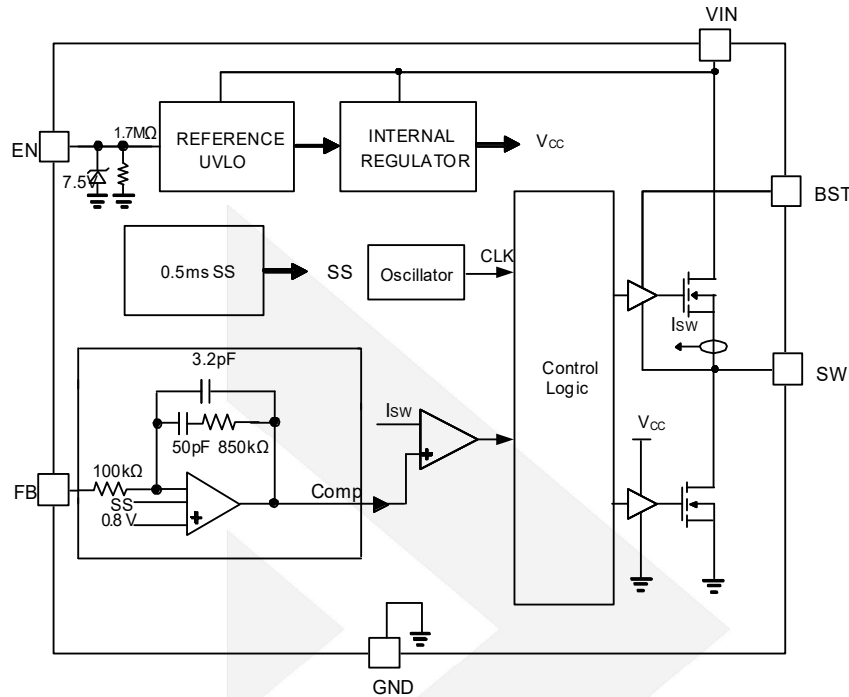

## OPERATION

The DIO61845 is a 2MHz, synchronous, step-down, switching regulator with integrated high-side and low-side power MOSFETs. The DIO61845 provides an internally compensated, highly efficient output of up to 0.6A with current-mode control and also features a wide input voltage range, internal soft-start control, and a precision current limit. Its very low operational quiescent current makes it suitable for battery-powered applications.

### Pulse-Width Modulation (PWM) Control

At moderate-to-high output currents, the DIO61845 operates in a fixed-frequency, peak-current-control mode to regulate the output voltage. A pulse-width modulation (PWM) cycle initiated by the internal clock turns on the power high-side MOSFET (HS-FET). The HS-FET remains on until its current reaches the value set by the COMP voltage ( $V_{COMP}$ ). After the HS-FET is off, the low-side MOSFET (LS-FET) turns on, and the inductor current flows through the LS-FET. To avoid a shoot-through, a dead time is inserted to prevent the HS-FET and LS-FET from turning on at the same time. For each turn-on and turn-off in a switching cycle, the HS-FET turns on and off with a minimum on and off time limit.

To prevent inductor current and output voltage runaway, the switching frequency folds back when the HS-FET minimum turn-on is detected internally.

When the PWM signal goes low, the HS-FET turns off and remains off for at least 100ns before the next cycle begins. If the current in the HS-FET does not reach the COMP-set current value within one PWM cycle, the HS-FET remains on to avoid a turn-off operation.

### Pulse-Skipping Mode (PSM)

Under light-load conditions, the DIO61845 enters pulse-skipping mode (PSM) to improve efficiency. PSM is triggered when  $V_{COMP}$  drops below the internal sleep threshold, which generates a pause command to block the turn-on clock pulse, so the power MOSFET does not turn on. This reduces gate driving and switching losses.

The pause command causes the entire chip to enter sleep mode, reducing the quiescent current to improve light-load efficiency.

When  $V_{COMP}$  exceeds the sleep threshold, the pause signal resets, and the chip resumes normal PWM operation. Whenever the pause command changes from low to high, the PWM signal goes high immediately and turns on the power MOSFET.

### Error Amplifier (EA)

The error amplifier is composed of an internal op-amp with an R-C feedback network connected between its output node (internal COMP node) and its negative input node (FB). When the FB voltage ( $V_{FB}$ ) drops below the internal reference voltage ( $V_{REF}$ ), the op-amp drives the COMP output high, producing a higher switch peak current output and delivering more energy to the output. Conversely, when  $V_{FB}$  rises above  $V_{REF}$ , the switch peak current output drops.

Connect FB to the tap of a voltage divider connected between  $V_{OUT}$  and GND composed of R1 and R2. R1 also serves to control the gain of the error amplifier in addition to the internal compensation R-C network.

### Internal Regulator

The 2.6V internal regulator powers most of the internal circuitry. This regulator takes the  $V_{IN}$  input and operates in the full  $V_{IN}$  range. When  $V_{IN}$  is greater than 3.0V, the output of the regulator is in full regulation. When  $V_{IN}$  drops below 3.0V, the output degrades.

### Enable Control (EN)

The DIO61845 has a dedicated enable control pin (EN). When  $V_{IN}$  rises above the threshold, EN can enable or disable the chip for high effective logic. Its falling threshold is 1.55V, and its rising threshold is about 1.8V. An internal 1.7M $\Omega$  resistor from EN to GND allows EN to be floated to shut down the chip.

When the EN voltage is pulled to 0V, the chip enters the lowest shutdown current mode. When the EN voltage rises above 0V but remains below the rising threshold, the chip remains in shutdown mode with a slightly higher shutdown current.

EN is clamped internally using a 7.5V series Zener diode. Connecting the EN input through a pull-up resistor to  $V_{IN}$  limits the EN input current below 100 $\mu$ A. For example, with 12V connected to  $V_{IN}$ ,  $R_{PULLUP} \geq (12V - 7.5V) \div 100\mu A = 45k\Omega$ .

Connecting EN to a voltage source directly without a pull-up resistor requires limiting the amplitude of the voltage source to  $\leq 6V$  to prevent damage to the Zener diode.

### Under-Voltage Lockout (UVLO)

$V_{IN}$  under-voltage lockout (UVLO) protects the chip from operating at an insufficient supply voltage. The UVLO rising threshold is approximately 4.6V, while its falling threshold is 3.9V.

### Internal Soft Start (SS)

A reference-type soft start (SS) prevents the converter output voltage from overshooting during start-up. When the chip starts up, the internal circuitry generates a soft-start voltage ( $V_{SS}$ ) that ramps up from 0V during the SS time. When  $V_{SS}$  is lower than  $V_{REF}$ ,  $V_{SS}$  overrides  $V_{REF}$  as the error amplifier reference.

The maximum  $V_{SS}$  value is approximately the same as  $V_{FB}$ , so if  $V_{FB}$  falls, the maximum of  $V_{SS}$  falls. This accommodates short-circuit recovery. When the short circuit is removed,  $V_{SS}$  ramps up to prevent an output voltage overshoot.

#### **Thermal Shutdown**

Thermal shutdown prevents thermal runaway. When the silicon die temperature exceeds its upper threshold, the entire chip shuts down. When the temperature drops below its lower threshold, the chip is enabled again.

#### **Floating Driver and Bootstrap Charging**

The floating power MOSFET driver is powered by an external bootstrap capacitor. This floating driver has its own UVLO protection with a rising threshold of about 2.4V and a falling threshold of about 300mV. During UVLO,  $V_{SS}$  resets to zero. When the UVLO ends, the controller enters soft start.

The bootstrap capacitor is charged and regulated to about 5V by the dedicated internal bootstrap regulator. And it will stop charging the bootstrap capacitor when DIO61845 enters pulses-skipping mode, so probe the BS node is forbidden to avoid discharging the bootstrap capacitor.

#### **Current Comparator and Current Limit**

A current-sense MOSFET senses the power MOSFET current. This current is input to the high-speed current comparator for current-mode control. When the power MOSFET turns on, the comparator is first blanked to limit noise, and then compares the power switch current against  $V_{COMP}$ . When the sensed value exceeds  $V_{COMP}$ , the comparator output goes low to turn off the power MOSFET. The maximum current of the internal power MOSFET is limited cycle-by-cycle internally. The switching frequency folds back to prevent an inductor current runaway during start-up or a short circuit.

#### **Low Dropout Operation**

The DIO61845 is designed to operate at almost 100% duty cycle to improve dropout. When the current in the HS-FET does not reach the COMP-set current value within one PWM cycle, the HS-FET remains on to prevent a turn-off operation. The HS-FET can remain on for a maximum of 15 $\mu$ s and then turns off for a minimum of 160ns.

To prevent the voltage across BST to SW from dropping too low during the low dropout operation, the current comparator enters power-save mode, in which the speed is degraded. This reduces the bootstrap capacitor current consumption when HS-FET turns on for longer than 2 $\mu$ s. Therefore, the voltage across the bootstrap capacitor can remain at a high level (close to 5V).

#### **Start-Up and Shutdown**

If both  $V_{IN}$  and  $V_{EN}$  exceed their respective thresholds, the chip starts up. The reference block first starts to generate a stable reference voltage and current, and then the internal regulator starts to provide a stable supply for the rest of the circuit.

While the internal supply rail is up, an internal timer turns the power MOSFET off for about 50 $\mu$ s to blank any start-up noise. When the internal soft-start block is enabled, it first holds its SS output low to ensure that the rest of the circuit is ready before ramping up.

Three events can shut down the chip: EN low,  $V_{IN}$  low, and thermal shutdown. During the shutdown procedure, the signaling path is blocked first to avoid any fault triggering.  $V_{COMP}$  and the internal supply rail are then pulled low. The floating driver is not subject to this shutdown command, but its charging path is disabled.

## Application Information

### Setting the Output Voltage

Set the output voltage of DIO61845 by using a resistor divider (see Figure 2):

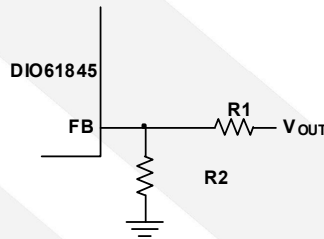

**Figure 2 FB Resistor Divider to Set  $V_{OUT}$**

Calculate the output voltage with Equation (1):

$$V_{OUT} = V_{FB} * \frac{(R1 + R2)}{R2} \quad (1)$$

The feedback resistor (R1) also sets the feedback loop bandwidth with the internal compensation network.

To achieve optimal stability performance and transient response, choose R1 to be around 1.5M $\Omega$  in power meter applications with a 12V output rail. Set R1 to be 56k $\Omega$  for 5V output rail applications. Then, calculate R2 with Equation (2):

$$R2 = \frac{R1}{\frac{V_{OUT}}{0.8V} - 1} \quad (2)$$

Table 1 lists the recommended feedback resistor values for common output voltages.

**Table 1 Resistor Selection vs. Output Voltage Setting**

$V_{OUT}$	R1	R2
5V	56k $\Omega$ (1%)	10.7k $\Omega$ (1%)
12V	1.5M $\Omega$ (1%)	107k $\Omega$ (1%)

### Selecting the Inductor

The inductor supplies constant current to the output load while being driven by the switched input voltage. A larger-value inductor results in less ripple current and a lower output ripple voltage but also has a larger physical size, higher series resistance, and lower saturation current.



To determine the inductance, allow the peak-to-peak ripple current in the inductor to be approximately 30% of the maximum load current and choose a peak inductor current below the maximum switch current limit. The inductance value can be calculated with Equation (3):

$$L1 = \frac{V_{OUT}}{f_s * \Delta I_L} * (1 - \frac{V_{OUT}}{V_{IN}}) \quad (3)$$

Where  $V_{OUT}$  is the output voltage,  $V_{IN}$  is the input voltage,  $f_s$  is the switching frequency, and  $\Delta I_L$  is the peak-to-peak inductor ripple current.

Choose an inductor that will not saturate under the maximum inductor peak current. The peak inductor current can be calculated with Equation (4):

$$I_{LP} = I_{LOAD} + \frac{V_{OUT}}{2 * f_s * L1} * (1 - \frac{V_{OUT}}{V_{IN}}) \quad (4)$$

Where  $I_{LOAD}$  is the load current.

Additionally, the inductor value influences the DIO61845 load ability during start-up. When the output voltage starts up,  $f_s$  folds back the minimum to several tens of kHz. Based on Equation (4), a smaller  $L1$  or a lower  $f_s$  leads to a higher  $I_{LP}$ . Therefore, if a small inductor value is used (e.g.: 10 $\mu$ H inductor in a 5V output rail power meter application), the current limit is reached when the DIO61845 starts up with a >250mA constant current load. Then, the output voltage fails to be set up. In this case, for a >250mA constant current load with a 10 $\mu$ H inductor, the DIO61845 must first start up with a load <250mA before increasing the current load. However, if the load is resistive, the DIO61845 can output a >250mA load sufficiently.

### Selecting the Input Capacitor

The input capacitor ( $C1$ ) can be electrolytic, tantalum, or ceramic. When using electrolytic or tantalum capacitors, add a small, high-quality, ceramic capacitor ( $C2$ ) (e.g.: 0.1 $\mu$ F) as close to the IC as possible. When using ceramic capacitors, ensure that they have enough capacitance to provide a sufficient charge to prevent excessive voltage ripple at the input.

The input voltage ripple caused by the capacitance can be estimated with Equation (5):

$$\Delta V_{IN} = \frac{I_{LOAD} * V_{OUT}}{f_s * C1 * V_{IN}} * (1 - \frac{V_{OUT}}{V_{IN}}) \quad (5)$$

### Selecting the Output Capacitor

An output capacitor ( $C4$ ) is required to maintain the DC output voltage. Ceramic, tantalum, or low ESR electrolytic capacitors are recommended. Low ESR capacitors are recommended to keep the output voltage ripple low. The output voltage ripple can be estimated with Equation (6):

$$\Delta V_{OUT} = \frac{V_{OUT}}{f_s * L} * (1 - \frac{V_{OUT}}{V_{IN}}) * (R_{ESR} + \frac{1}{8 * f_s * C4}) \quad (6)$$

Where  $L$  is the inductor value, and  $R_{ESR}$  is the equivalent series resistance (ESR) value of the output capacitor.

In the case of ceramic capacitors, the impedance at the switching frequency is dominated by the capacitance. The output voltage ripple is caused mainly by the capacitance. For simplification, the output voltage ripple can be estimated with Equation (7):

$$\Delta V_{OUT} = \frac{V_{OUT}}{8 * f_S^2 * L * C4} * (1 - \frac{V_{OUT}}{V_{IN}}) \quad (7)$$

In the case of tantalum or electrolytic capacitors, the ESR dominates the impedance at the switching frequency. For simplification, the output ripple can be approximated with Equation (8):

$$\Delta V_{OUT} = \frac{V_{OUT}}{f_S * L} * (1 - \frac{V_{OUT}}{V_{IN}}) * R_{ESR} \quad (8)$$

The characteristics of the output capacitor also affect the stability of the regulation system.

In power meter applications, the output capacitors are large-value electrolytic capacitors, typically, with an RESR and capacitance with a large temperature variation. This large temperature variation changes the part's feedback loop, making it difficult to keep the loop stable over the full operation temperature, especially when the DIO61845 works in a deep dropout mode ( $V_{IN}-V_{OUT}<1V$ ). It is recommended that the capacitance of the electrolytic capacitor be less than 560 $\mu$ F, and  $R_{ESR}$  should be greater than 70m $\Omega$  at room temperature.

### Compensation Components

The goal of compensation design is to shape the converter transfer function to achieve a desirable loop gain. Lower crossover frequencies result in slower line and load transient responses, while higher crossover frequencies can cause system instability. Generally, set the crossover frequency to equal approximately one-tenth of the switching frequency. If using an electrolytic capacitor, select a loop bandwidth no higher than 1/4 of the ESR zero frequency ( $f_{ESR}$ ), where  $f_{ESR}$  can be calculated with Equation (9):

$$f_{ESR} = \frac{1}{2\pi * C4 * R_{ESR}} \quad (9)$$

### High Duty Cycle Application Limit

To improve low dropout performance, the DIO61845 duty cycle is designed very close to 100% by scaling down the switching frequency approximatively when  $V_{IN}$  is close to  $V_{OUT}$ .

However, when the DIO61845 operates in deep dropout mode ( $V_{IN}-V_{OUT}<1V$ ), an additional pole appears within the bandwidth of the feedback loop. This additional pole reduces the loop phase margin and may cause some instability, which makes the output voltage ripple increase. In power meter applications with a 12V output rail, the minimum  $V_{IN}$  should be higher than 12.8V. It is recommended that the capacitance of the output electrolytic capacitor be less than 560 $\mu$ F, and  $R_{ESR}$  should be greater than 70m $\Omega$ . If  $V_{IN}$  drops below  $V_{OUT}$ ,  $V_{COMP}$  increases to its high clamped voltage. Because  $V_{COMP}$  needs time to recover from a high-to-low clamp, the output voltage experiences an overshoot when  $V_{IN}$  steps up higher than  $V_{OUT}$  quickly.

The DIO61845's slope compensation is not enough to prevent the current limit from dropping too low in dropout mode when the inductor value is small. For example, if a 10 $\mu$ H inductor is used in power meter 5V output rail applications, the DIO61845 may suffer instability around  $V_{IN}=7V$ . To avoid this instability, use a high-value inductor.

Table 2 shows a component selection guide for power meter 12V and 5V output rail applications.

Table 2 Components Selection Guide

V <sub>OUT</sub>	Load	R1	R2	L1	C3	C4	
						Capacitance	R <sub>ESR</sub>
5V	200mA	56kΩ (1%)	10.7kΩ (1%)	10μH	0.1μF		
	600mA	56kΩ (1%)	10.7kΩ (1%)	22μH	0.1μF		
12V	600mA	1.5MΩ (1%)	107kΩ (1%)	22μH	0.1μF	470μF	>70mΩ

### Short-Circuit Application Limit

The DIO61845 implements short-circuit protection (SCP) by scaling down the frequency when a fault occurs. However, SCP is guaranteed at  $V_{IN} \leq 25V$ . At  $V_{IN} > 25V$ , due to a low response speed of the current limit loop, there is a risk that the inductor current will rush high when SCP enters with a special slew rate.

### PCB Layout Guidelines

Efficient PCB layout requires high-frequency noise considerations to limit voltage spikes on the SW node.

1. Keep the path of the input decoupling capacitor, VIN, SW, and PGND as short as possible using short and wide traces.
2. Keep the passive components as close to the device as possible.
3. Run the feedback trace far from the inductor and noisy power traces. If possible, run the feedback trace on the opposite side of the PCB from the inductor, separated by a ground plane. Expect greater switching losses at high switching frequencies.
4. Add a grid of thermal vias under the exposed pad to improve thermal conductivity.
5. Use small vias (15mil barrel diameter) so that the hole fills during the plating process and prevent solder wicking during the reflow process associated with larger vias.
6. Use a pitch (distance between the centers) of approximately 40mil between the thermal vias.

## Typical Performance Characteristic

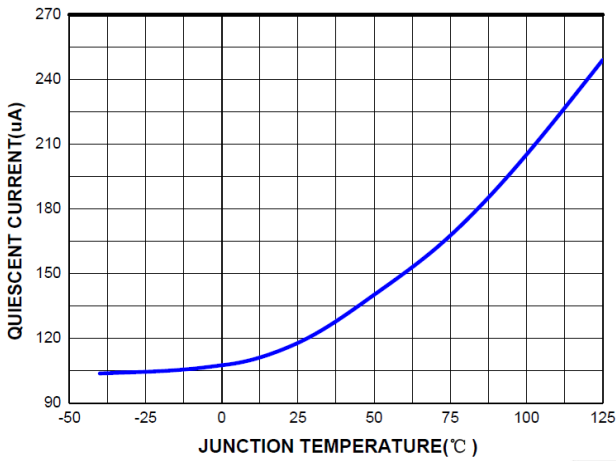

Figure 3. Quiescent Current vs. Junction Temperature

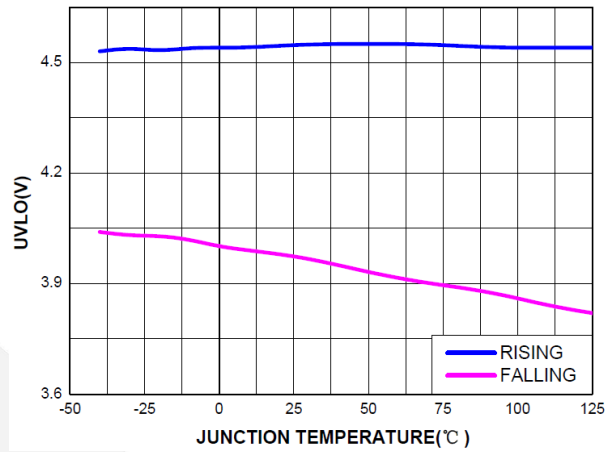

Figure 4. Vin UVLO vs. Junction Temperature

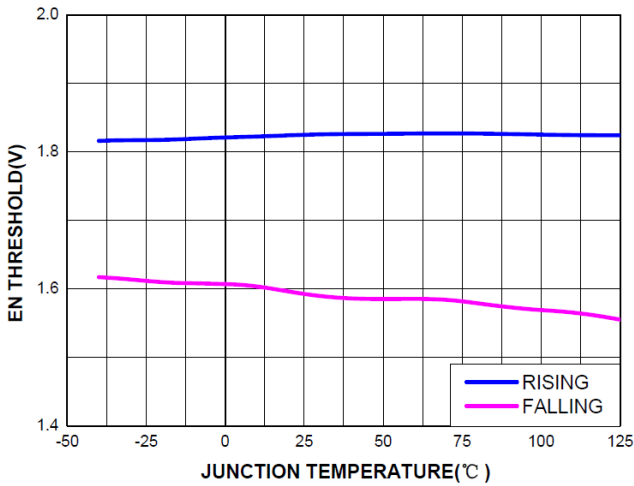

Figure 5. EN Threshold vs. Junction Temperature

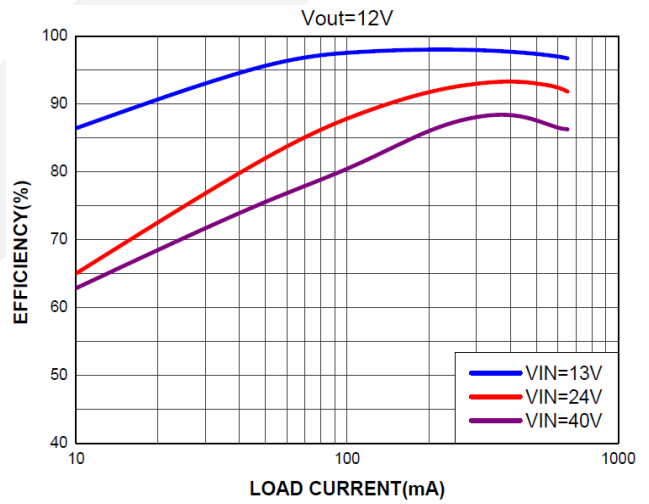
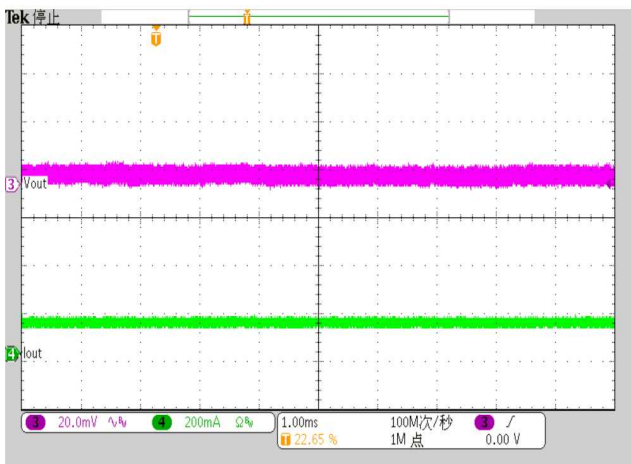
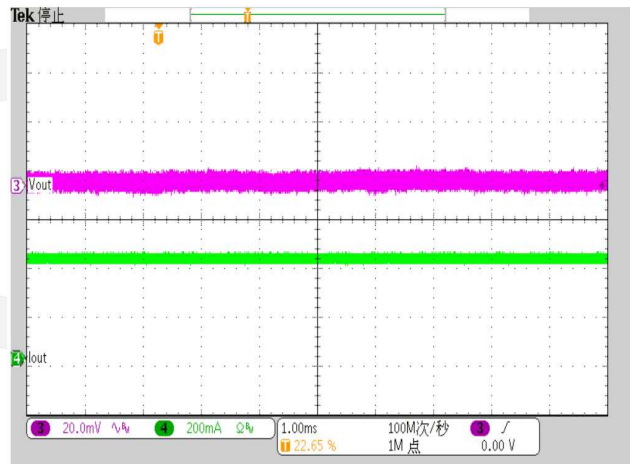

Figure 6. Efficiency vs. Load Current



Iout=0.125A

Figure 7. Output Voltage Ripple



Iout=0.4A

Figure 8. Output Voltage Ripple

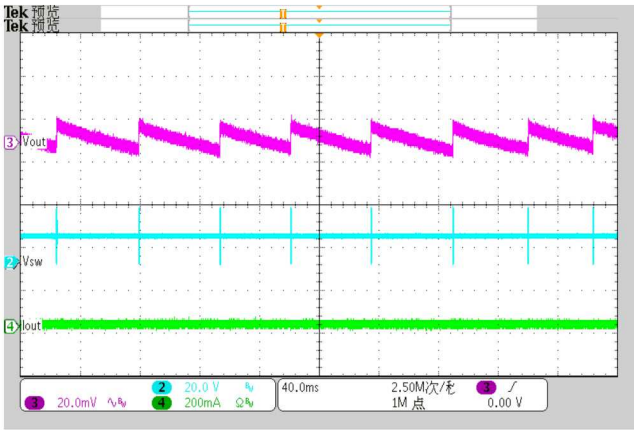

$I_{out} = 0A$

Figure 9. Steady State

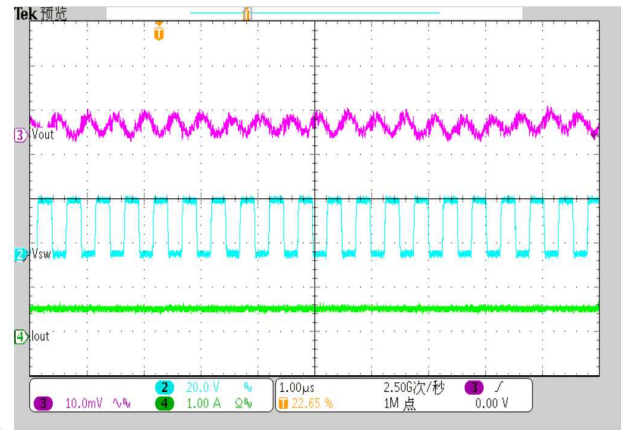

$I_{out} = 0.6A$

Figure 10. Steady State

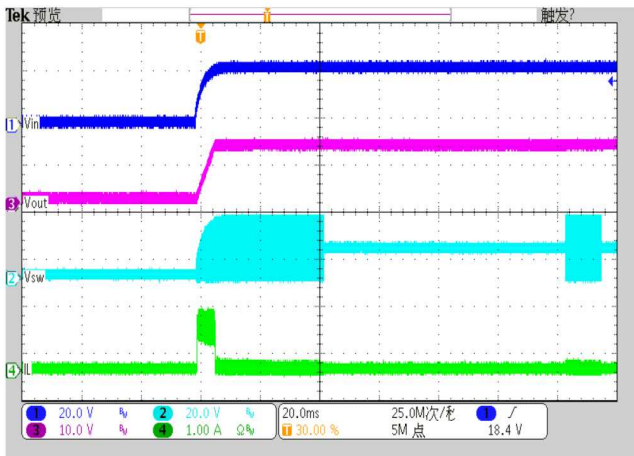

$I_{out} = 0A$

Figure 11. Start up through  $V_{in}$

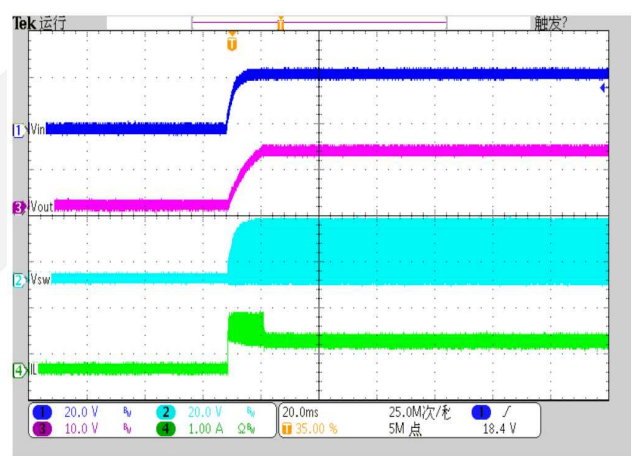

$I_{out} = 0.6A$

Figure 12. Start up through  $V_{in}$

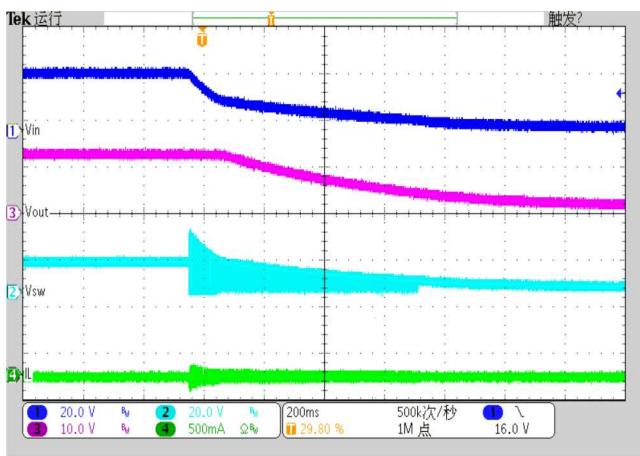

$I_{out} = 0A$

Figure 13. Shutdown through  $V_{in}$

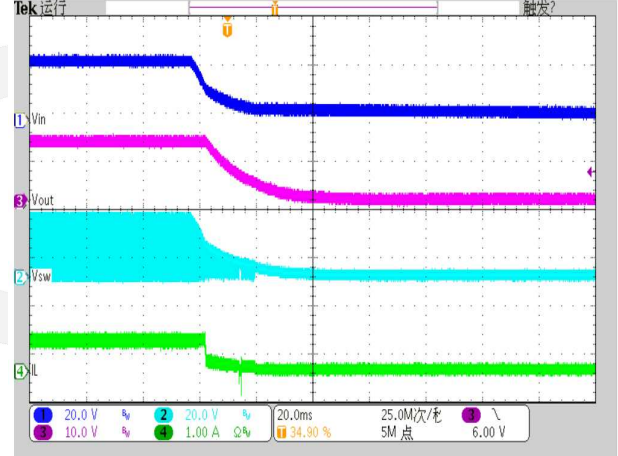

$I_{out} = 0.6A$

Figure 14. Shutdown through  $V_{in}$

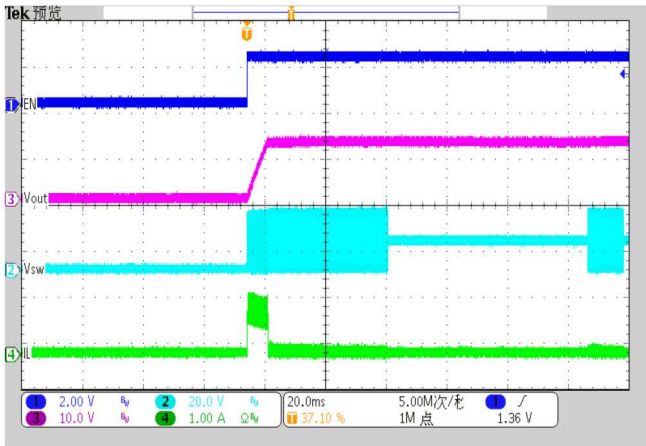

Iout=0A

Figure 15. Start up through EN

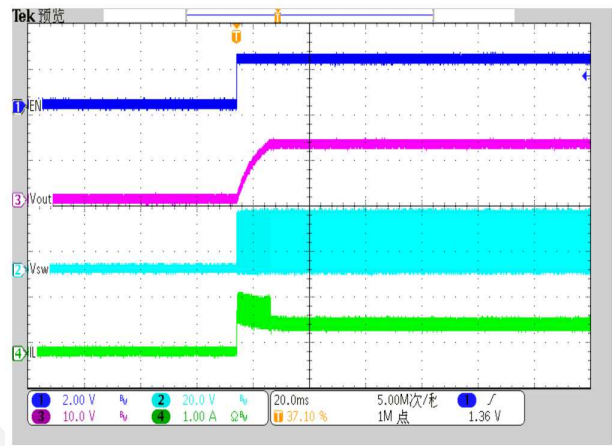

Iout=0.6A

Figure 16. Start up through EN

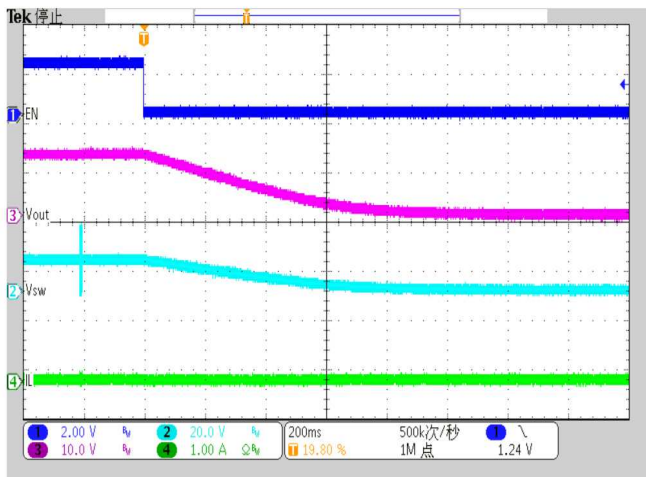

Iout=0A

Figure 17. Shutdown through EN

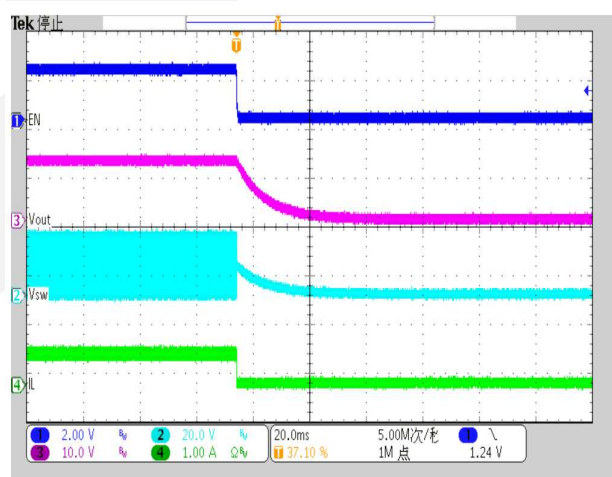

Iout=0A

Figure 18. Shutdown through EN

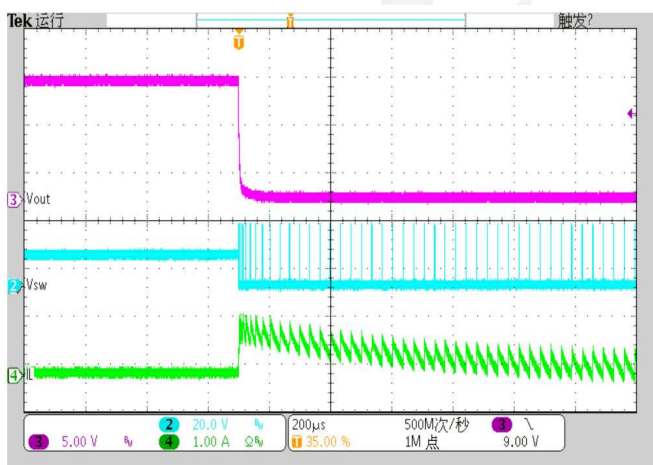

Iout=0A to short circuit

Figure 19. SCP Entry

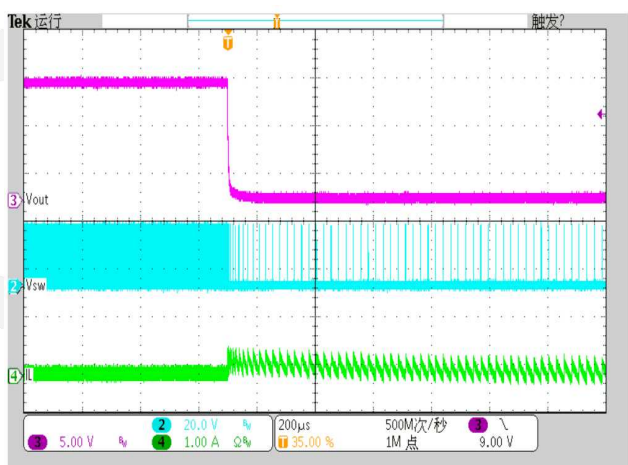

Iout=0.6A to short circuit

Figure 20. SCP Entry

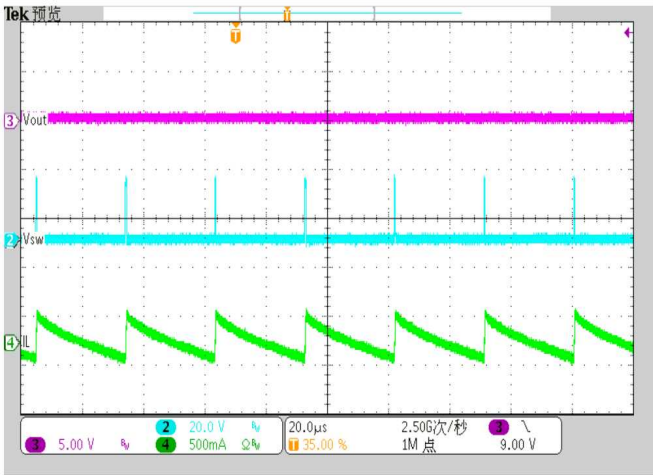
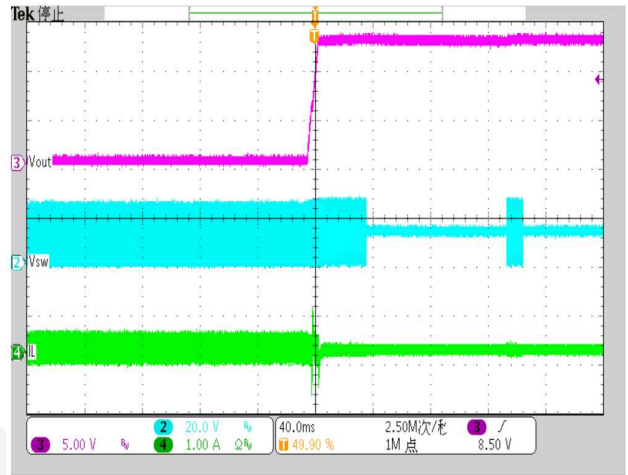
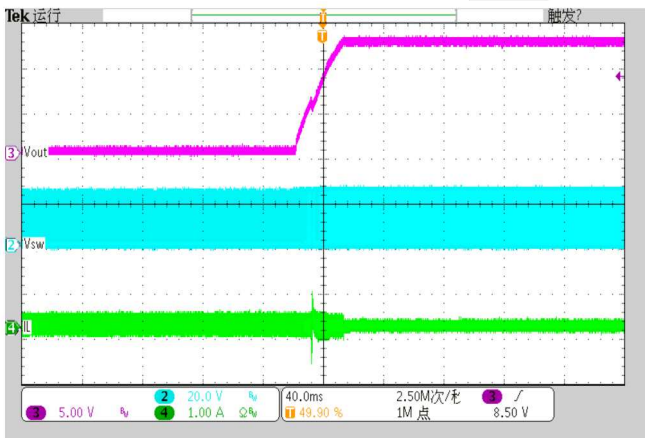

Figure 21. SCP Steady State



short circuit to  $I_{out}=0A$   
Figure 22. SCP Recovery



short circuit to  $I_{out}=0.6A$   
Figure 23. SCP Recovery

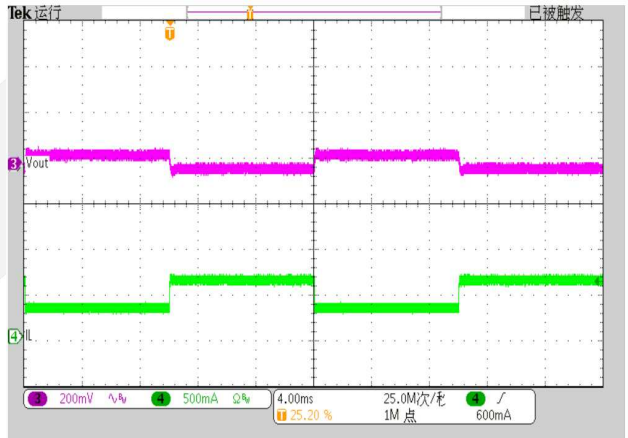

$I_{out}=0.3A \leftrightarrow 0.6A$  1.6A/us  
Figure 24. Load Transient

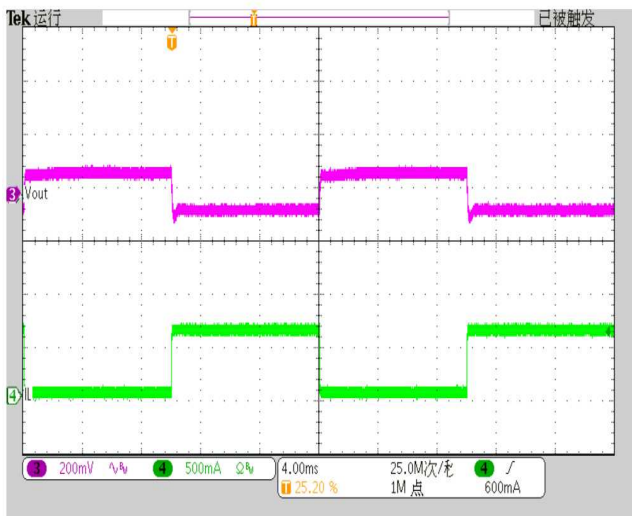

$I_{out}=10mA \leftrightarrow 0.6A$  1.6A/us  
Figure 25. Load Transient

## CONTACT US

Dioo is a professional design and sales corporation for high-quality and performance analog semiconductors. The company focuses on industry markets, such as, cell phone, handheld products, laptop, and medical equipment and so on. Dioo's product families include analog signal processing and amplifying, LED drivers and charger IC. Go to <http://www.dioo.com> for a complete list of Dioo product families.

For additional product information, or full datasheet, please contact with our Sales Department or Representatives.

